

**ÚNICO  
SENCILLO Y  
PRÁCTICO**

**IMEX**  
BATH EQUIPMENTS



2023 AVANCE



# IMEX BATH EQUIPMENTS

---



Imex Products, S.L.

Imex es una empresa ubicada en Picassent (Valencia) dedicada a la fabricación y comercialización de barras de ducha y griferías. Empezamos nuestra andadura en el año 2001, suministrando materiales de baño y duchas a empresas fabricantes del sector.

Con el paso de los años y la experiencia acumulada hemos desarrollado una serie de productos con un diseño y un precio muy competitivo en el mercado.

Nuestros productos son de gama media – alta, utilizando siempre las mejores materias primas que se encuentran en el mercado, como latón de primera calidad o acero S304 y S316, que nos han hecho tener representación en el territorio nacional e internacional. En Imex intentamos siempre estar a la cabeza del diseño, por eso se apuesta por el I+D+I constantemente.

Nuestros valores como empresa son, la fabulosa relación calidad – diseño y precio. Y nuestros compromisos con los clientes son los siguientes:

- Conseguir los más altos estándares de calidad
- Tener presente que el cliente es nuestra primera preocupación y su satisfacción nuestro principal objetivo.
- Rodearnos de grandes profesionales

Para todo ello intentamos adoptar una posición de mejora continua e innovación.

El resultado de todo esto se ve reflejado en el catálogo que le mostramos a continuación.





PROFESSIONAL  
**IMEX**  
DESIGN



**MONZA** SERIE  
**CROMO**











# MONZA

## CROMO

SERIE





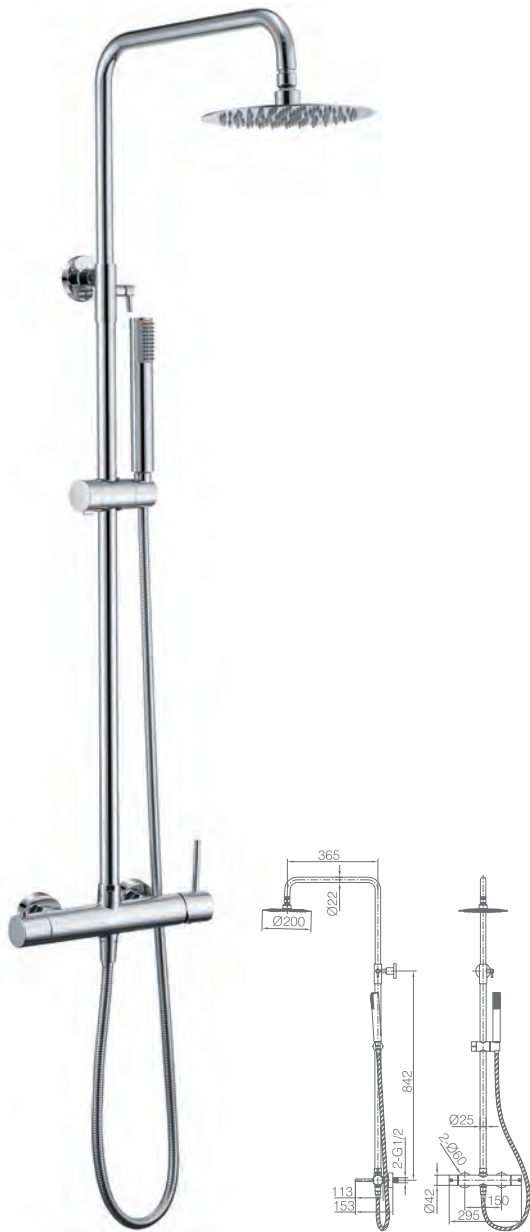

Ref.: **BDM039**

- Barra de ducha de acero inox. S.304 redonda extensible de 88/124 cm. cromo.
- Rociador de acero inox. S.304 Ø20cm, extraplano, cromo y antical.
- Soporte mango de ducha regulable en altura cromo.
- Mango de ducha redondo de 1 posición cromo.
- Grifería monomando de latón cromo con distribuidor incorporado.
- Caudal medio 12 l/min.
- Flexo PVC 150cm.
- Cartucho monomando cerámico Ø35 mm.

Cod.: 00173.00



Ref.: **BTM039**

- Barra de ducha de acero inox. S.304, redonda extensible de 88/124 cm. cromo.
- Rociador de acero inox. S.304 Ø20cm, extraplano, cromo y antical.
- Soporte mango de ducha regulable en altura cromo.
- Mango de ducha redondo de 1 posición cromo.
- Grifería termostática de latón cromo con distribuidor incorporado.
- Caudal medio 12 l/min.
- Flexo PVC 150cm.
- Cartucho termostático autolimpiante TURN CLEAN SYSTEM (patentado).

Cod.: 00207.00





# MONZA

## CROMO

SERIE

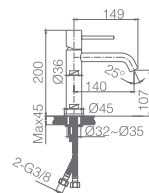

Ref.: **BDM039-1**

Monomando de lavabo.  
Cuerpo de grifería en latón.  
Acabado cromo.  
Cartucho cerámico Ø 25 mm.  
Flexos 3/8"

Grifería con certificación



Cod.: **00054.00**

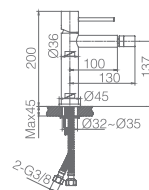

Ref.: **BDM039-2**

Monomando de bidé.  
Cuerpo de grifería en latón.  
Acabado cromo.  
Cartucho cerámico Ø 25 mm.  
Flexos 3/8"

Grifería con certificación



Cod.: **00054.00**

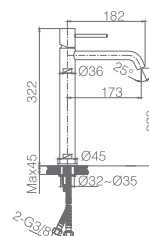

Ref.: **BDM039-3**

Monomando de lavabo.  
Cuerpo de grifería en latón.  
Acabado cromo.  
Cartucho cerámico Ø 25 mm.  
Flexos 3/8"

Grifería con certificación



Cod.: **00073.00**







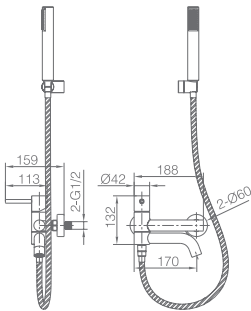

Ref.: **BDM039-4**

Grifería para baño/ducha en latón.  
Acabado cromo.  
Soporte para mango de ducha de ABS.  
Mango ducha redondo 1 posición.  
Flexo reforzado 180cm.  
Inversor caño abatible.  
Caudal medio 12 l/min.  
Cartucho monomando cerámico Ø 35mm.

**Cod.: 00129.00**



Grifería con certificación

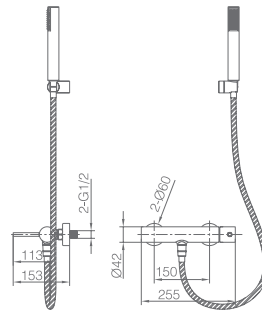

Ref.: **BDM039-5**

Grifería para ducha en latón.  
Acabado cromo.  
Soporte para mango de ducha de ABS.  
Mango ducha redondo 1 posición.  
Flexo reforzado 180cm.  
Caudal medio 12 l/min.  
Cartucho monomando cerámico Ø 35mm.

**Cod.: 00102.00**



Grifería con certificación





# MONZA

## CROMO

SERIE











PROFESSIONAL  
**IMEX**  
DESIGN





Ref.: **GPM039**

Rociador de acero inox. S.304 Ø25cm, extraplano, cromado y antical.  
 Tubo salida pared de latón cromado.  
 Mango de ducha redondo de 1 posición.  
 Grifería monomando de latón cromado de 2 vías.  
 Caudal medio 20 l/min.  
 Distribuidor redondo de latón.  
 Flexo PVC 150cm.  
 Cartucho monomando Ø 35 mm.  
 Soporte mango de ducha con salida agua pared.  
 Cuerpo empotrado a pared con caja de registro.

**Cod.: 00185.00**



Ref.: **GPT039**

Opcion tubo salida techo de latón cromado.

**Cod.: 00185.00**



Ref.: **GTM039**

Rociador de acero inox. S.304 Ø25cm, extraplano, cromado y antical.  
 Tubo salida pared de latón cromado.  
 Mango de ducha cromado redondo de 1 posición.  
 Grifería termostática de latón cromado de 2 vías.  
 Caudal medio 20 l/min.  
 Distribuidor redondo de latón cromado.  
 Flexo PVC 150cm.  
 Cartucho termostático TURN CLEAN SYSTEM  
 Soporte mango de ducha cromado con salida agua pared.  
 Cuerpo empotrado a pared con caja de registro.

**Cod.: 00269.00**



Ref.: **GTT039**

Opcion tubo salida techo de latón cromado.

**Cod.: 00269.00**





# MONZA

## CROMO

SERIE



Ref.: GLM039

Grifería empotrada monomando  
Latón cromado.  
En dos partes independientes.  
Cuerpo empotrado directo a pared.  
Sin caja de registro.

Cod.: 00065.00

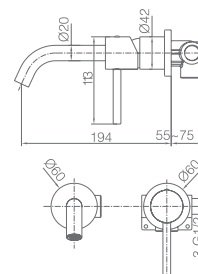







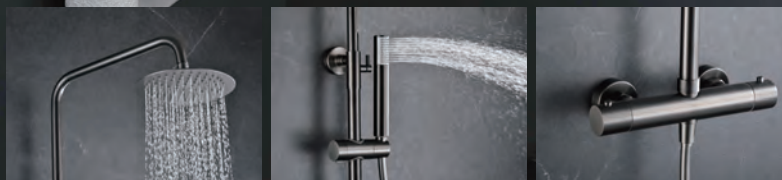

**MONZA** SERIE  
BLACK GUN METAL



# MONZA

BLACK GUN METAL  
SERIE









**Ref.: BDM039/BGM**

- Barra de ducha de acero inox. S.304 redonda extensible de 88/124 cm. acabado black gun metal.
- Rociador de acero inox. S.304 Ø20cm, extraplano, acabado black gun metal y antical.
- Soporte mango de ducha regulable en altura acabado black gun metal.
- Mango de ducha redondo de 1 posición acabado black gun metal.
- Grifería monomando de latón acabado black gun metal con distribuidor incorporado.
- Caudal medio 12 l/min.
- Flexo PVC 150cm.
- Cartucho monomando cerámico Ø35 mm.

**Cod.: 00261.00**



**Ref.: BTM039/BGM**

- Barra de ducha de acero inox. S.304, redonda extensible de 88/124 cm. black gun metal.
- Rociador de acero inox. S.304 Ø20cm, extraplano, black gun metal y antical.
- Soporte mango de ducha regulable en altura black gun metal.
- Mango de ducha redondo de 1 posición black gun metal.
- Grifería termostática de latón black gun metal con distribuidor incorporado.
- Caudal medio 12 l/min.
- Flexo PVC 150cm.
- Cartucho termostático autolimpiable TURN CLEAN SYSTEM (patentado).

**Cod.: 00296.00**



# MONZA

## BLACK GUN METAL

SERIE

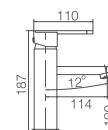

Ref.: **BDM039-1BGM**

Monomando de lavabo.  
Cuerpo de grifería en latón.  
Acabado black gun metal  
Cartucho cerámico Ø 25 mm.  
Flexos 3/8"

Grifería con  
certificación



Cod.: **00067.00**

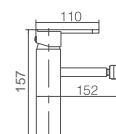

Ref.: **BDM039-2BGM**

Monomando de bidé.  
Cuerpo de grifería en latón.  
Acabado black gun metal  
Cartucho cerámico Ø 25 mm.  
Flexos 3/8"

Grifería con  
certificación



Cod.: **00066.00**

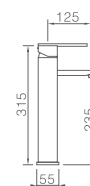

Ref.: **BDM039-3BGM**

Monomando de lavabo.  
Cuerpo de grifería en latón.  
Acabado black gun metal.  
Cartucho cerámico Ø 25 mm.  
Flexos 3/8"

Grifería con  
certificación



Cod.: **00086.00**



# MONZA

## BLACK GUN METAL

SERIE



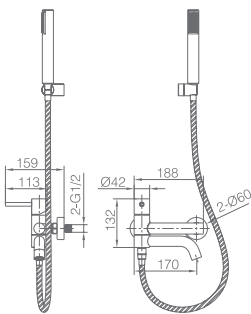

Ref.: **BDM039-4BGM**

Grifería para baño/ducha en latón.  
 Acabado black gun metal.  
 Soporte para mango de ducha de ABS.  
 Mango ducha redondo 1 posición.  
 Flexo PVC 180cm.  
 Inversor caño abatible.  
 Caudal medio 12 l/min.  
 Cartucho monomando cerámico Ø 35mm.

Grifería con certificación

Cod.: 00169.00

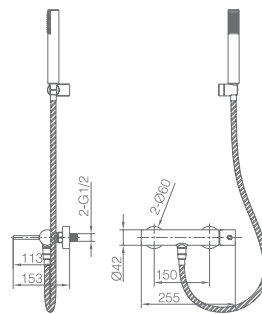

Ref.: **BDM039-5BGM**

Grifería para ducha en latón.  
 Acabado black gun metal.  
 Soporte para mango de ducha de ABS.  
 Mango ducha redondo 1 posición.  
 Flexo PVC 180cm.  
 Caudal medio 12 l/min.  
 Cartucho monomando cerámico Ø 35mm.

Grifería con certificación

Cod.: 00134.00







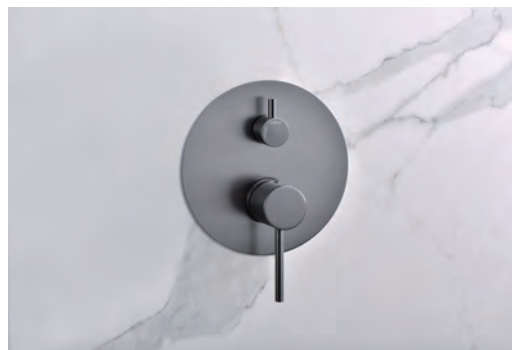

# MONZA

BLACK GUN METAL

SERIE







PVD

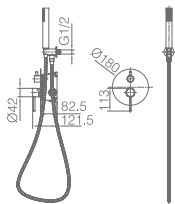
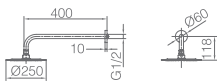

Ref.: **GPM039/BGM**

Rociador de acero inox. S.304 Ø25cm, extraplano, black gun metal y antical.  
 Tubo salida pared de latón black gun metal.  
 Mango de ducha black gun metal redondo de 1 posición.  
 Grifería monomando de latón black gun metal de 2 vías.  
 Caudal medio 20 l/min.  
 Distribuidor redondo de latón black gun metal.  
 Flexo PVC 150cm black gun metal  
 Cartucho monomando Ø 35 mm.  
 Soporte mango de ducha black gun metal con salida agua pared.  
 Cuerpo empotrado a pared con caja de registro.

Cod.: **00239.00**



Ref.: **GPT039/BGM**

Opcion tubo salida techo de latón acabado black gun metal.

Cod.: **00239.00**

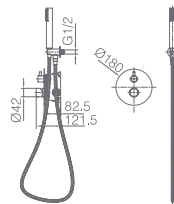
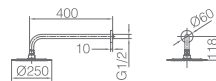

Ref.: **GTM039/BGM**

Rociador de acero inox. S.304 Ø25cm, extraplano, black gun metal y antical.  
 Tubo salida pared de latón black gun metal.  
 Mango de ducha black gun metal redondo de 1 posición.  
 Grifería termostática de latón black gun metal de 2 vías.  
 Caudal medio 20 l/min.  
 Distribuidor redondo de latón black gun metal.  
 Flexo PVC 150cm black gun metal.  
 Cartucho termostático TURN CLEAN SYSTEM  
 Soporte mango de ducha black gun metal con salida agua pared.  
 Cuerpo empotrado a pared con caja de registro.

Cod.: **00334.00**



Ref.: **GTT039/BGM**

Opcion tubo salida techo de latón acabado black gun metal.

Cod.: **00334.00**



# MONZA

## BLACK GUN METAL

SERIE



Ref.: **GLM039/BGM**

Grifería empotrada monomando  
Latón acabado black gun metal.  
En dos partes independientes.  
Cuerpo empotrado directo a pared.  
Sin caja de registro.

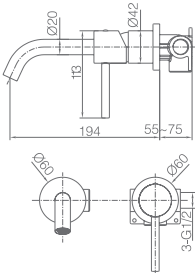

Cod.: 00079.00









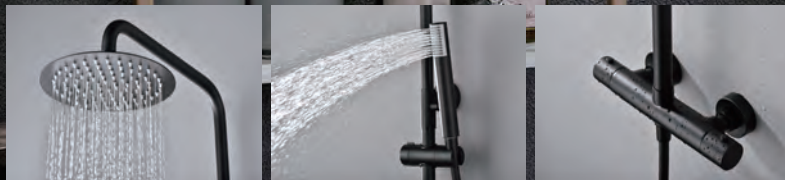

**MONZA** SERIE  
NEGRO MATE









# MONZA

NEGRO MATE

SERIE

ELECTROFÓRESIS

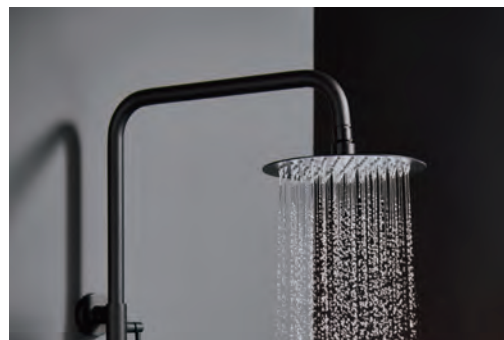





Ref.: **BDM039/NG**

- Barra de ducha de acero inox. S.304 redonda extensible de 88/124 cm. acabado negro mate.
- Rociador de acero inox. S.304 Ø20cm, extraplano, acabado negro mate y antical.
- Soporte mango de ducha regulable en altura acabado negro mate.
- Mango de ducha redondo de 1 posición acabado negro mate.
- Grifería monomando de latón acabado negro mate con distribuidor incorporado.
- Caudal medio 12 l/min.
- Flexo PVC 150cm.
- Cartucho monomando cerámico Ø35 mm.

Cod.: 00192.00

Grifería con certificación



Ref.: **BTM039/NG**

- Barra de ducha de acero inox. S.304, redonda extensible de 88/124 cm. negro mate.
- Rociador de acero inox. S.304 Ø20cm, extraplano, negro mate y antical.
- Soporte mango de ducha regulable en altura negro mate.
- Mango de ducha redondo de 1 posición negro mate.
- Grifería termostática de latón negro mate con distribuidor incorporado.
- Caudal medio 12 l/min.
- Flexo PVC 150cm.
- Cartucho termostático autolimpiante TURN CLEAN SYSTEM (patentado).

Cod.: 00239.00

Grifería con certificación



# MONZA

NEGRO MATE

SERIE

ELECTROFÓRESIS

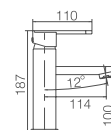
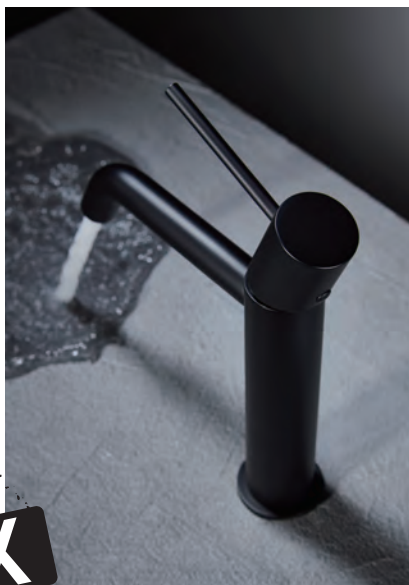

Ref.: BDM039-1NG

Monomando de lavabo.  
Cuerpo de grifería en latón.  
Acabado negro mate.  
Cartucho cerámico Ø 25 mm.  
Flexos 3/8"

Grifería con certificación

Cod.: 00059.00

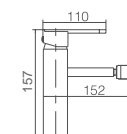

Ref.: BDM039-2NG

Monomando de bidé.  
Cuerpo de grifería en latón.  
Acabado negro mate.  
Cartucho cerámico Ø 25 mm.  
Flexos 3/8"

Grifería con certificación

Cod.: 00058.00

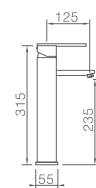

Ref.: BDM039-3NG

Monomando de lavabo alto.  
Cuerpo de grifería en latón.  
Acabado negro mate.  
Cartucho cerámico Ø 25 mm.  
Flexos 3/8"

Grifería con certificación

Cod.: 00077.00





# MONZA

## NEGRO MATE

SERIES

ELECTROFÓRESIS



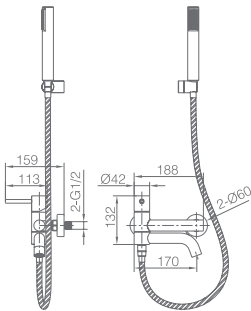

Ref.: **BDM039-4NG**

Grifería para baño/ducha en latón.  
 Acabado negro mate.  
 Soporte para mango de ducha de ABS.  
 Mango ducha redondo 1 posición.  
 Flexo PVC 180cm.  
 Inversor caño abatible.  
 Caudal medio 12 l/min.  
 Cartucho monomando cerámico Ø 35mm. Grifería con certificación

**Cod.: 00140.00**

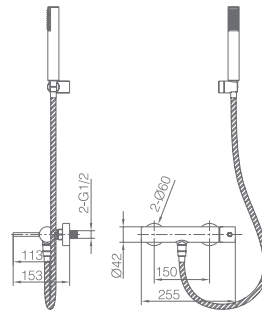

Ref.: **BDM039-5NG**

Grifería para ducha en latón.  
 Acabado negro mate.  
 Soporte para mango de ducha de ABS.  
 Mango ducha redondo 1 posición.  
 Flexo PVC 180cm.  
 Caudal medio 12 l/min.  
 Cartucho monomando cerámico Ø 35mm. Grifería con certificación

**Cod.: 00110.00**

















Ref.: **GPM039/NG**

Rociador de acero inox. S.304 Ø25cm, extraplano, negro mate y antical.  
 Tubo salida pared de latón negro mate.  
 Mango de ducha negro mate redondo de 1 posición.  
 Grifería monomando de latón negro mate de 2 vías.  
 Caudal medio 20 l/min.  
 Distribuidor redondo de latón negro mate  
 Flexo PVC 150cm negro mate  
 Cartucho monomando Ø 35 mm.  
 Soporte mango de ducha negro mate con salida agua pared.  
 Cuerpo empotrado a pared con caja de registro.

Cod.: **00199.00**



Ref.: **GPT039/NG**

Opcion tubo salida techo de latón acabado negro mate.

Cod.: **00199.00**



Ref.: **GTM039/NG**

Rociador de acero inox. S.304 Ø25cm, extraplano, negro mate y antical.  
 Tubo salida pared de latón negro mate.  
 Mango de ducha negro mate redondo de 1 posición.  
 Grifería termostática de latón negro mate de 2 vías.  
 Caudal medio 20 l/min.  
 Distribuidor redondo de latón negro mate.  
 Flexo PVC 150cm negro mate.  
 Cartucho termostático TURN CLEAN SYSTEM  
 Soporte mango de ducha negro mate con salida agua pared.  
 Cuerpo empotrado a pared con caja de registro.

Cod.: **00287.00**



Ref.: **GTT039/NG**

Opcion tubo salida techo de latón acabado negro mate.

Cod.: **00287.00**





# MONZA

## NEGRO MATE

SERIE

ELECTROFÓRESIS



Ref: **GLM039/NG**

Grifería empotrada monomando  
Latón acabado negro mate.  
En dos partes independientes.  
Cuerpo empotrado directo a pared.  
Sin caja de registro.

Cod.: 00069.00

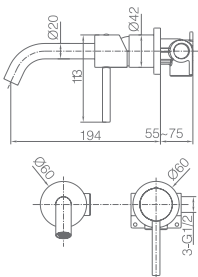



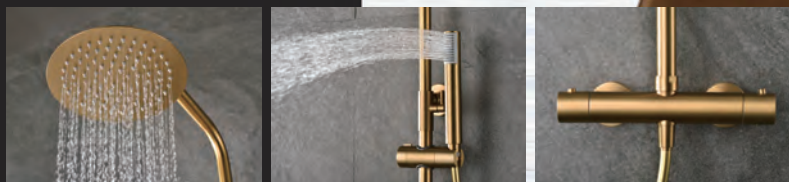

**MONZA** SERIE  
ORO CEPILLADO









# MONZA

ORO CEPILLADO  
SERIE

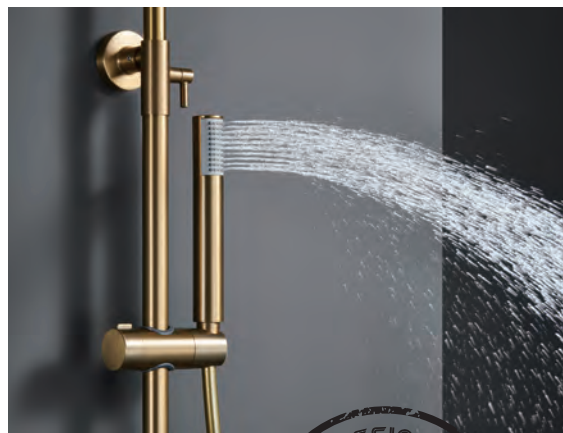



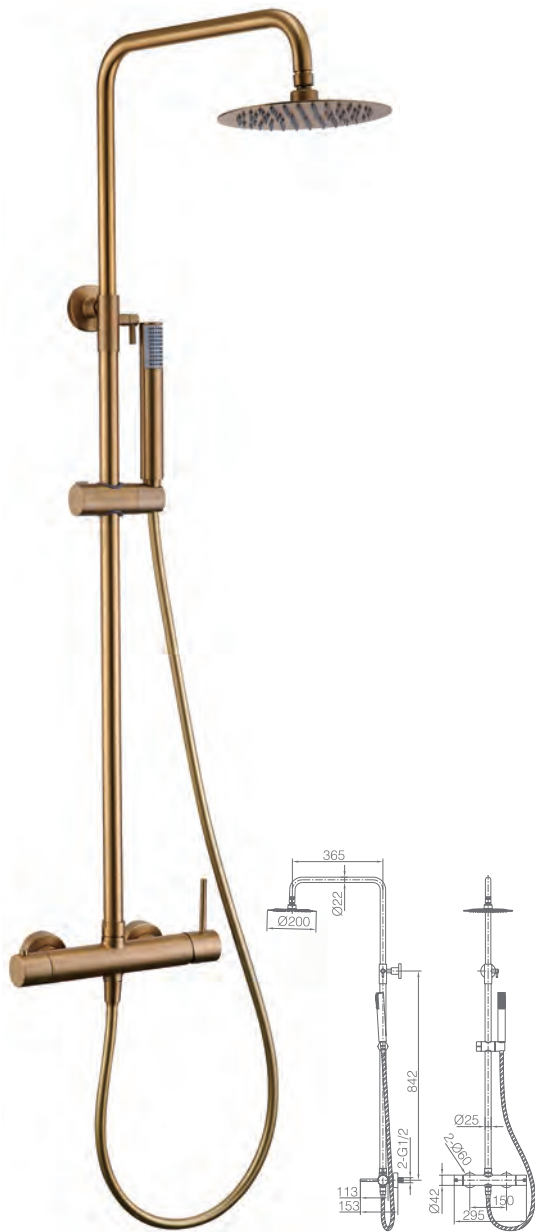

Ref.: **BDM039/OC**

- Barra de ducha de acero inox. S.304 redonda extensible de 88/124 cm. acabado oro cepillado.
- Rociador de acero inox. S.304 Ø20cm, extraplano, acabado oro cepillado y antical.
- Soporte mango de ducha regulable en altura acabado oro cepillado.
- Mango de ducha redondo de 1 posición acabado oro cepillado.
- Grifería monomando de latón acabado oro cepillado con distribuidor incorporado.
- Caudal medio 12 l/min.
- Flexo PVC 150cm.
- Cartucho monomando cerámico Ø35 mm.

Cod.: 00252.00

Grifería con certificación



Ref.: **BTM039/OC**

- Barra de ducha de acero inox. S.304, redonda extensible de 88/124 cm. oro cepillado.
- Rociador de acero inox. S.304 Ø20cm, extraplano, oro cepillado y antical.
- Soporte mango de ducha regulable en altura oro cepillado.
- Mango de ducha redondo de 1 posición oro cepillado.
- Grifería termostática de latón oro cepillado con distribuidor incorporado.
- Caudal medio 12 l/min.
- Flexo PVC 150cm.
- Cartucho termostático autolimpiante TURN CLEAN SYSTEM (patentado).

Cod.: 00289.00

Grifería con certificación



# MONZA

## ORO CEPILLADO

SERIE

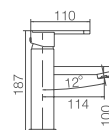

Ref.: **BDM039-1OC**

Monomando de lavabo.  
Cuerpo de grifería en latón.  
Acabado oro cepillado.  
Cartucho cerámico Ø 25 mm.  
Flexos 3/8"

Grifería con certificación

Cod.: **00067.00**

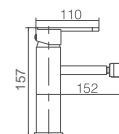

Ref.: **BDM039-2OC**

Monomando de bidé.  
Cuerpo de grifería en latón.  
Acabado oro cepillado.  
Cartucho cerámico Ø 25 mm.  
Flexos 3/8"

Grifería con certificación

Cod.: **00066.00**

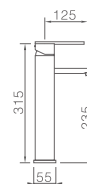

Ref.: **BDM039-3OC**

Monomando de lavabo alto.  
Cuerpo de grifería en latón.  
Acabado oro cepillado.  
Cartucho cerámico Ø 25 mm.  
Flexos 3/8"

Grifería con certificación

Cod.: **00086.00**







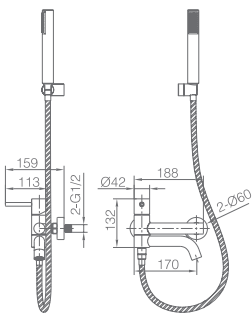

Ref.: **BDM039-40C**

Grifería para baño/ducha en latón.  
 Acabado oro cepillado.  
 Soporte para mango de ducha de ABS.  
 Mango ducha redondo 1 posición.  
 Flexo PVC 180cm.  
 Inversor caño abatible.  
 Caudal medio 12 l/min.  
 Cartucho monomando cerámico Ø 35mm.

Cod.: **00161.00**

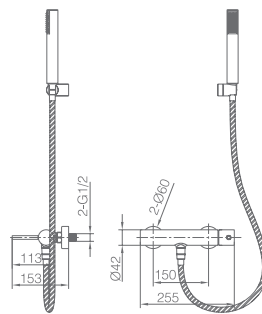

Ref.: **BDM039-50C**

Grifería para ducha en latón.  
 Acabado oro cepillado.  
 Soporte para mango de ducha de ABS.  
 Mango ducha redondo 1 posición.  
 Flexo PVC 180cm.  
 Caudal medio 12 l/min.  
 Cartucho monomando cerámico Ø 35mm.

Cod.: **00127.00**





# MONZA

## ORO CEPILLADO

SERIE

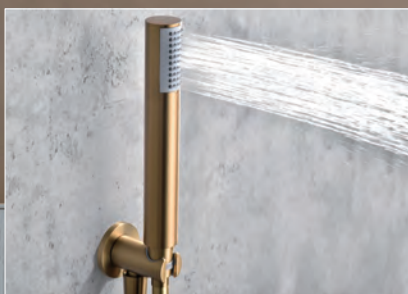









PVD



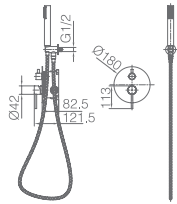
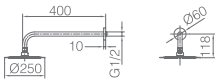

Ref.: **GPM039/OC**

Rociador de acero inox. S.304 Ø25cm, extraplano, oro cepillado y antical.  
 Tubo salida pared de latón oro cepillado.  
 Mango de ducha oro cepillado redondo de 1 posición.  
 Grifería monomando de latón oro cepillado de 2 vías.  
 Caudal medio 20 l/min.  
 Distribuidor redondo de latón oro cepillado.  
 Flexo PVC 150cm oro cepillado  
 Cartucho monomando Ø 35 mm.  
 Soporte mango de ducha oro cepillado con salida agua pared.  
 Cuerpo empotrado a pared con caja de registro.

Cod.: **00239.00**

Grifería con certificación



Ref.: **GPT039/OC**

Opcion tubo salida techo de latón acabado oro cepillado.

Cod.: **00239.00**

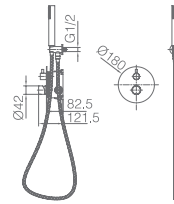
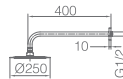

Ref.: **GTM039/OC**

Rociador de acero inox. S.304 Ø25cm, extraplano, oro cepillado y antical.  
 Tubo salida pared de latón oro cepillado.  
 Mango de ducha oro cepillado redondo de 1 posición.  
 Grifería termostática de latón oro cepillado de 2 vías.  
 Caudal medio 20 l/min.  
 Distribuidor redondo de latón oro cepillado.  
 Flexo PVC 150cm oro cepillado.  
 Cartucho termostático TURN CLEAN SYSTEM  
 Soporte mango de ducha oro cepillado con salida agua pared.  
 Cuerpo empotrado a pared con caja de registro.

Cod.: **00334.00**

Grifería con certificación



Ref.: **GTT039/OC**

Opcion tubo salida techo de latón acabado oro cepillado.

Cod.: **00334.00**





# MONZA

## ORO CEPILLADO

SERIE



Ref.: **GLM039/OC**

Grifería empotrada monomando  
 Latón acabado oro cepillado.  
 En dos partes independientes.  
 Cuerpo empotrado directo a pared.  
 Sin caja de registro.

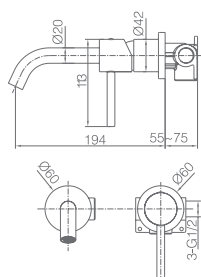

Cod.: 00079.00













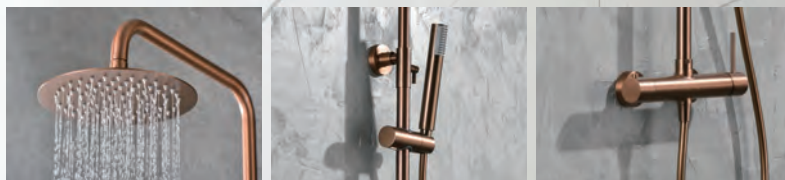

**MONZA** SERIE  
ORO ROSA CEPILLADO



# MONZA

ORO ROSA CEPILLADO

SERIE









Ref.: **BDM039/ORC**

- Barra de ducha de acero inox. S.304 redonda extensible de 88/124 cm. acabado oro rosa cepillado.
- Rociador de acero inox. S.304 Ø20cm, extraplano, acabado oro rosa cepillado y antical.
- Soporte mango de ducha regulable en altura acabado oro rosa cepillado.
- Mango de ducha redondo de 1 posición acabado oro rosa cepillado.
- Grifería monomando de latón acabado oro rosa cepillado con distribuidor incorporado.
- Caudal medio 12 l/min.
- Flexo PVC 150cm.
- Cartucho monomando cerámico Ø35 mm.

Cod.: 00261.00



Ref.: **BTM039/ORC**

- Barra de ducha de acero inox. S.304, redonda extensible de 88/124 cm. oro rosa cepillado.
- Rociador de acero inox. S.304 Ø20cm, extraplano, oro rosa cepillado y antical.
- Soporte mango de ducha regulable en altura oro rosa cepillado.
- Mango de ducha redondo de 1 posición oro rosa cepillado.
- Grifería termostática de latón oro rosa cepillado con distribuidor incorporado.
- Caudal medio 12 l/min.
- Flexo PVC 150cm.
- Cartucho termostático autolimpiante TURN CLEAN SYSTEM (patentado).

Cod.: 00296.00



# MONZA

## ORO ROSA CEPILLADO

SERIE

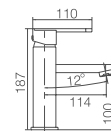

Ref.: **BDM039-1ORC**

Monomando de lavabo.  
Cuerpo de grifería en latón.  
Acabado oro rosa cepillado.  
Cartucho cerámico Ø 25 mm.  
Flexos 3/8"

Grifería con certificación



Cod.: **00067.00**

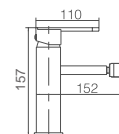

Ref.: **BDM039-2ORC**

Monomando de bidé.  
Cuerpo de grifería en latón.  
Acabado oro rosa cepillado.  
Cartucho cerámico Ø 25 mm.  
Flexos 3/8"

Grifería con certificación



Cod.: **00066.00**

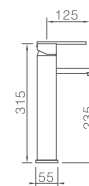

Ref.: **BDM039-3ORC**

Monomando de lavabo alto.  
Cuerpo de grifería en latón.  
Acabado oro rosa cepillado.  
Cartucho cerámico Ø 25 mm.  
Flexos 3/8"

Grifería con certificación



Cod.: **00086.00**





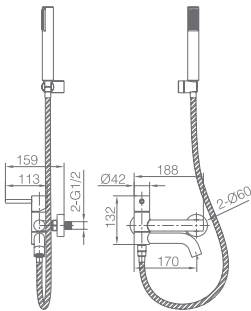
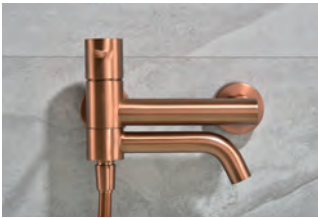

Ref.: **BDM039-4ORC**

Grifería para baño/ducha en latón.  
 Acabado oro rosa cepillado.  
 Soporte para mango de ducha de ABS.  
 Mango ducha redondo 1 posición.  
 Flexo PVC 180cm.  
 Inverso caño abatible.  
 Caudal medio 12 l/min.  
 Cartucho monomando cerámico Ø 35mm. Grifería con certificación

**Cod.: 00169.00**

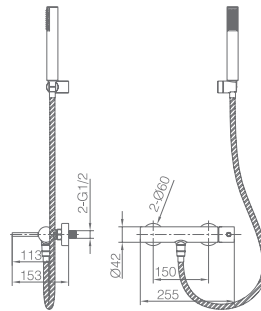

Ref.: **BDM039-5ORC**

Grifería para ducha en latón.  
 Acabado oro rosa cepillado.  
 Soporte para mango de ducha de ABS.  
 Mango ducha redondo 1 posición.  
 Flexo PVC 180cm.  
 Caudal medio 12 l/min.  
 Cartucho monomando cerámico Ø 35mm. Grifería con certificación

**Cod.: 00134.00**





# MONZA

ORO ROSA CEPILLADO

SERIE









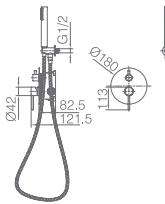
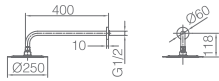

Ref.: **GPM039/ORC**

Rociador de acero inox. S.304 Ø25cm, extraplano, oro rosa cepillado y antical.  
 Tubo salida pared de latón oro rosa cepillado.  
 Mango de ducha oro rosa cepillado redondo de 1 posición.  
 Grifería monomando de latón oro rosa cepillado de 2 vías.  
 Caudal medio 20 l/min.  
 Distribuidor redondo de latón oro rosa cepillado.  
 Flexo PVC 150cm oro rosa cepillado.  
 Cartucho monomando Ø 35 mm.  
 Soporte mango de ducha oro rosa cepillado con salida agua pared.  
 Cuerpo empotrado a pared con caja de registro.

Cod.: **00239.00**

Grifería con certificación



Ref.: **GPT039/ORC**

Opcion tubo salida techo de latón acabado oro rosa cepillado.

Cod.: **00239.00**

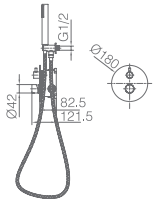
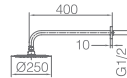
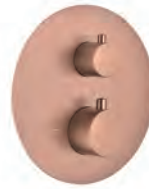

Ref.: **GTM039/ORC**

Rociador de acero inox. S.304 Ø25cm, extraplano, oro rosa cepillado y antical.  
 Tubo salida pared de latón oro rosa cepillado.  
 Mango de ducha oro rosa cepillado redondo de 1 posición.  
 Grifería termostática de latón oro rosa cepillado de 2 vías.  
 Caudal medio 20 l/min.  
 Distribuidor redondo de latón oro rosa cepillado.  
 Flexo PVC 150cm oro rosa cepillado.  
 Cartucho termostático TURN CLEAN SYSTEM  
 Soporte mango de ducha oro rosa cepillado con salida agua pared.  
 Cuerpo empotrado a pared con caja de registro.

Cod.: **00334.00**

Grifería con certificación



Ref.: **GTT039/ORC**

Opcion tubo salida techo de latón acabado oro rosa cepillado.

Cod.: **00334.00**



# MONZA

ORO ROSA CEPILLADO

SERIE





Ref.: **GLM039/ORC**

Grifería empotrada monomando  
Latón acabado oro rosa cepillado.  
En dos partes independientes.  
Cuerpo empotrado directo a pared.  
Sin caja de registro.

Cod.: **00079.00**

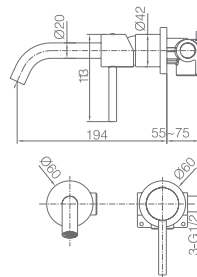



# MUNICH

SERIE  
BIDÉ EMPOTRADO







# MUNICH

## CROMO

SERIE



### Ref.: RDM001

Grifería empotrada de bidé.  
Agua fría y caliente.  
Mango de 1 posición.  
Latón acabado cromo.  
Flexo de acero reforzado de 100 cm antiexplosión.  
Tapón especial pre-montaje en latón cromado, alta resistencia. Cuerpo con caja de registro.

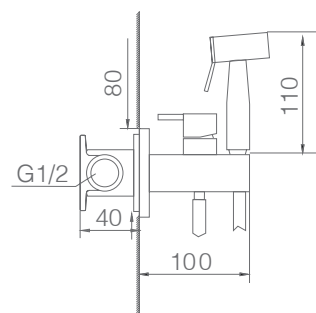

Cod.: 00087.50







# MUNICH

## BLACK GUN METAL

SERIE



**Ref.: RDM001/BGM**

Grifería empotrada de bidé.  
Agua fría y caliente.  
Mango de 1 posición.  
Latón acabado black gun metal.  
Flexo PVC de 100 cm antiexplosión.  
Tapón especial pre-montaje en latón cromado, alta resistencia. Cuerpo con caja de registro.

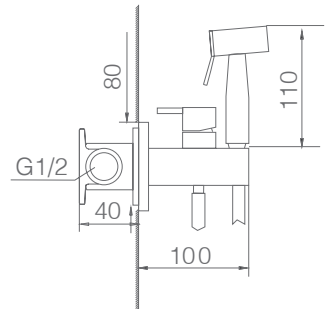

Cod.: 00129.00





# MUNICH

## NEGRO MATE

SERIE

**ELECTROFÓRESIS**

**Ref.: RDM001/NG**

Grifería empotrada de bidé.

Agua fría y caliente.

Mango de 1 posición.

Latón acabado negro mate.

Flexo PVC de 100 cm antiexplosión.

Tapón especial pre-montaje en latón cromado, alta resistencia. Cuerpo con caja de registro.

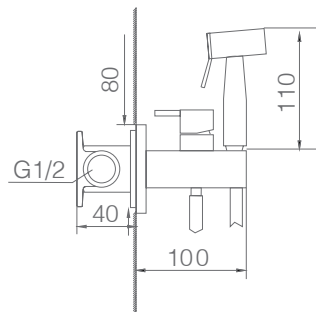

Cod.: 00099.00









# MUNICH

## ORO CEPILLADO

SERIE

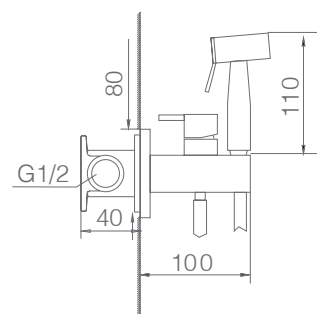
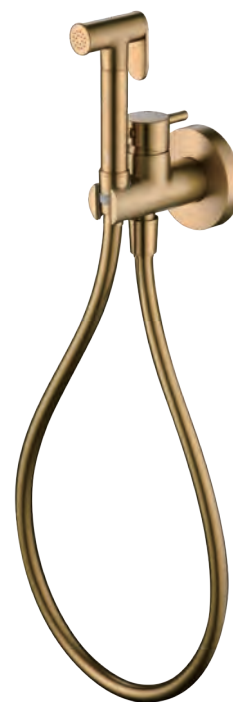

**Ref.: RDM001/OC**

Grifería empotrada de bidé.  
Agua fría y caliente.  
Mango de 1 posición.  
Latón acabado oro cepillado.  
Flexo PVC de 100 cm antiexplosión.  
Tapón especial pre-montaje en latón cromado, alta resistencia. Cuerpo con caja de registro.

Cod.: 00126.00





# MUNICH

## ORO ROSA CEPILLADO

SERIE

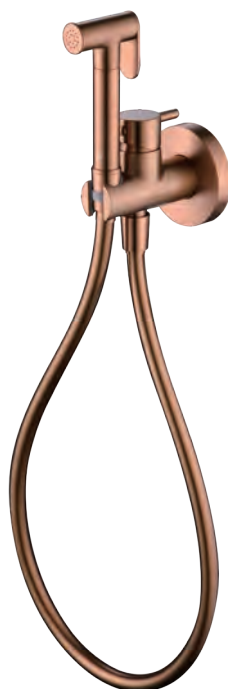

**Ref.: RDM001/ORC**

Grifería empotrada de bidé.  
Agua fría y caliente.  
Mango de 1 posición.  
Latón acabado oro rosa cepillado.  
Flexo PVC de 100 cm antiexplosión.  
Tapón especial pre-montaje en latón cromado, alta resistencia. Cuerpo con caja de registro.

Cod.: 00129.00

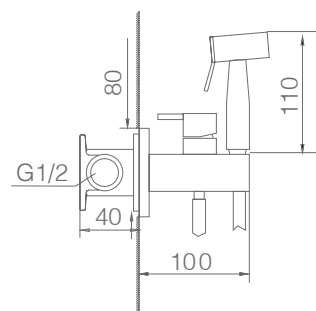





# CÓRCEGA

SERIE

GRIFERÍA EXENTA





# CÓRCEGA

## CROMO

SERIE

### Ref.: BBECO1

Grifería exenta de bañera en latón.  
Acabado cromo.  
Cartucho cerámico Ø35 mm.  
Mango de ducha redondo, 1 posición  
Flexo de pvc.  
Caja de registro a suelo.

Cod.: 00380.50

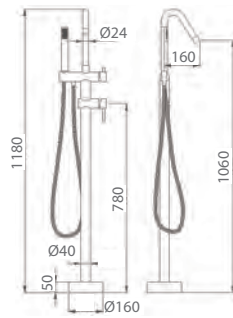







# CÓRCEGA

## BLACK GUN METAL

SERIE

Ref.: **BBECO1/BGM**

Grifería exenta de bañera en latón.  
Acabado black gun metal  
Cartucho cerámico Ø35 mm.  
Mango de ducha redondo, 1 posición  
Flexo de pvc.  
Caja de registro a suelo.

Cod.: 00475.00

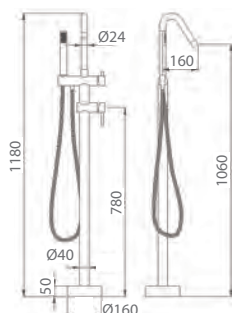



# CÓRCEGA

## NEGRO MATE

SERIE

Ref.: BBECO1/NG

Grifería exenta de bañera en latón  
Acabado negro mate.  
Cartucho cerámico Ø 35 mm.  
Mango de ducha redondo, 1 posición  
Flexo de PVC.  
Caja de registro a suelo.

Cod.: 00440.00



ELECTROFÓRESIS

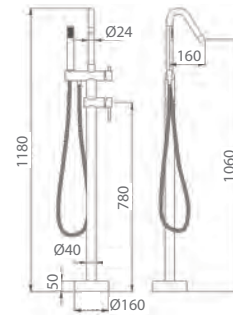





# CÓRCEGA

## ORO CEPILLADO

SERIE

Ref.: BBECO1/OC

Grifería exenta de bañera en latón.  
Acabado oro cepillado.  
Cartucho cerámico Ø35 mm.  
Mango de ducha redondo, 1 posición  
Flexo de PVC.  
Caja de registro a suelo.

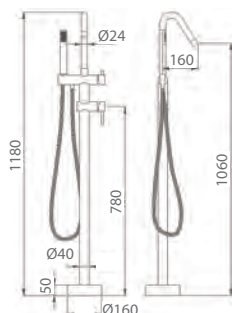

Cod.: 00475.00









# CÓRCEGA

## ORO ROSA CEPILLADO

SERIE

Ref.: BBECO1/ORC

Grifería exenta de bañera en latón.  
Acabado oro rosa cepillado.  
Cartucho cerámico Ø35 mm.  
Mango de ducha redondo, 1 posición  
Flexo de PVC.  
Caja de registro a suelo.

Cod.: 00475.00

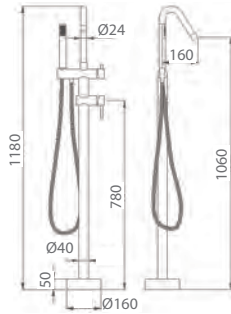



# COMPLEMENTOS

# VALVULAS

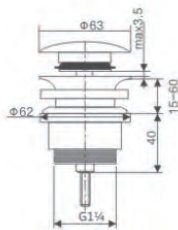

Ref.: VCC001

Apta para todos los lavabos y bidés, con o sin rebosadero.  
Sistema de apertura/cierre garantizado para ciclos de 20.000 usos.

Rosca inferior de Ø1 1/4".  
Fabricadas en latón, cromado.  
Montaje rápido y sencillo.

Cod.: 00010.50

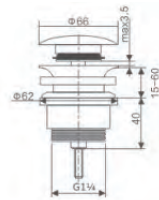

Ref.: VCC008(negro mate)

Apta para todos los lavabos y bidés, con o sin rebosadero.  
Sistema de apertura/cierre garantizado para ciclos de 20.000 usos.

Rosca inferior de Ø1 1/4".  
Fabricadas en latón, negro mate.  
Montaje rápido y sencillo.

Cod.: 00014.50

SISTEMA LACADO  
ELECTROFORESIS

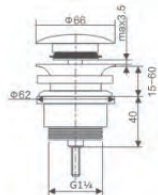

Ref.: VCC014 (oro cepillado)

PVD

Apta para todos los lavabos y bidés, con o sin rebosadero.  
Sistema de apertura/cierre garantizado para ciclos de 20.000 usos.

Rosca inferior de Ø1 1/4".  
Fabricadas en latón y zamak.  
Acabado PVD oro cepillado  
Montaje rápido y sencillo.

Cod.: 00019.90

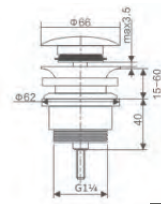

Ref.: VCC023 (oro rosa cepillado)

PVD

Apta para todos los lavabos y bidés, con o sin rebosadero.  
Sistema de apertura/cierre garantizado para ciclos de 20.000 usos.

Rosca inferior de Ø1 1/4".  
Fabricadas en latón y zamak.  
Acabado PVD oro rosa cepillado.  
Montaje rápido y sencillo.

Cod.: 00019.90

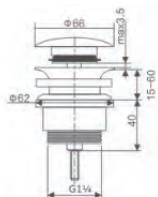

Ref.: VCC018 (black gun metal)

Apta para todos los lavabos y bidés, con o sin rebosadero.  
Sistema de apertura/cierre garantizado para ciclos de 20.000 usos.

Rosca inferior de Ø1 1/4".  
Fabricadas en latón y zamak.  
Acabado PVD black gun metal.  
Montaje rápido y sencillo.

Cod.: 00019.90

PVD





# VALVULAS (PVC)



SISTEMA LACADO  
ELECTROFORESIS

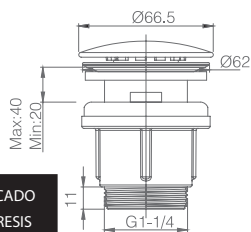

## Ref.: VCC019 (negro mate)

Apta para todos los lavabos y bidés, con o sin rebosadero.  
Sistema de apertura/cierre garantizado para ciclos de 20.000 usos.  
Rosca inferior de Ø1 ¼".  
Fabricadas en PVC y acero S304 acabado negro mate.  
Montaje rápido y sencillo.

Cod.: 00010.00

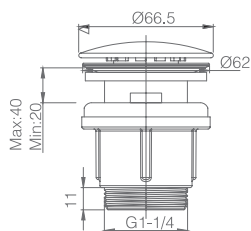

## Ref.: VCC0021 (oro rosa cepillado)

Apta para todos los lavabos y bidés, con o sin rebosadero.  
Sistema de apertura/cierre garantizado para ciclos de 20.000 usos.  
Rosca inferior de Ø1 ¼".  
Fabricadas en PVC y acero S304 acabado oro rosa cepillado.  
Montaje rápido y sencillo.

Cod.: 00011.00

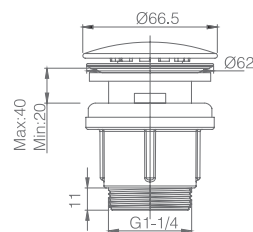

## Ref.: VCC020 (oro cepillado)

Apta para todos los lavabos y bidés, con o sin rebosadero.  
Sistema de apertura/cierre garantizado para ciclos de 20.000 usos.  
Rosca inferior de Ø1 ¼".  
Fabricadas en PVC y acero S304 acabado oro cepillado.  
Montaje rápido y sencillo.

Cod.: 00011.00

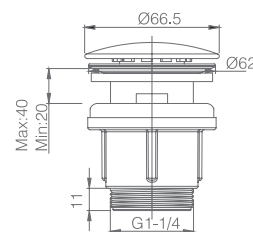

## Ref.: VCC022 (black gun metal)

Apta para todos los lavabos y bidés, con o sin rebosadero.  
Sistema de apertura/cierre garantizado para ciclos de 20.000 usos.  
Rosca inferior de Ø1 ¼".  
Fabricadas en PVC y acero S304 acabado black gun metal.  
Montaje rápido y sencillo.

Cod.: 00011.00

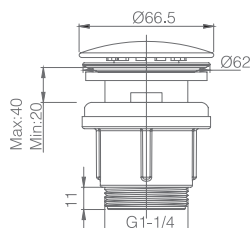

## Ref.: VCC009

Apta para todos los lavabos y bidés, con o sin rebosadero.  
Sistema de apertura/cierre garantizado para ciclos de 20.000 usos.  
Rosca inferior de Ø1 ¼".  
Fabricadas en PVC y acero S304 acabado cromado.  
Montaje rápido y sencillo.

Cod.: 00008.50



# SIFONES



Ref.: **SCL002** Cod.: **00017.50**

Sifon visto redondo cromado  
Base desmontable, fácil limpieza.

Material : Acero s304 y zamak  
Acabado : Cromado



Ref.: **SCL002/BGM** Cod.: **00035.00**

Sifon visto redondo  
Base desmontable, fácil limpieza.

Material : Acero s304 y zamak  
Acabado : Black gun metal



Ref.: **SCL002/OC** Cod.: **00035.00**

Sifon visto redondo  
Base desmontable, fácil limpieza.

Material : Acero s304 y zamak  
Acabado : Oro cepillado



**ELECTROFORESIS**

Ref.: **SCL002/NG** Cod.: **00023.00**

Sifon visto redondo negro mate  
Base desmontable, fácil limpieza.

Material : Acero s304 y zamak  
Acabado : Negro mate

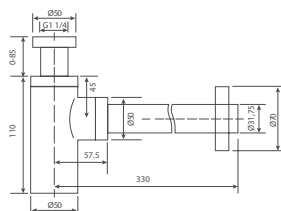

Ref.: **SCL002/OC** Cod.: **00035.00**

Sifon visto redondo  
Base desmontable, fácil limpieza.

Material : Acero s304 y zamak  
Acabado : Oro cepillado



Ref.: **1EXP0002-B**



# CONDICIONES GENERALES DE VENTA

## ENTREGAS

Revise la mercancía a la recepción de la misma. No se aceptará ninguna reclamación sobre mercancía no revisada en el momento de su recepción. El transportista indicará tal efecto en el albarán de entrega.

## DEVOLUCIONES

En caso de devolución defina claramente el motivo de la misma.  
IMEX aceptará toda devolución que cumpla las siguientes premisas:  
-El material deberá tener algún defecto de fabricación.  
-El embalaje deberá estar en perfecto estado, de no ser así se le aplicará un recargo de un 10% en factura en concepto de recepción, revisión y manipulación.

## FORMA DE PAGO

Se emitirá recibo a través de entidad bancaria.  
Giro máximo 30 días fecha factura  
Cualquier impagado que se produzca conllevará el pago de la factura más todos los gastos bancarios ocasionados y retención de todos los pedidos hasta el pago del mismo.

## TRIBUNALES

En caso de litigio ambas partes se someterán a los tribunales de Picassent (VALENCIA).

## PORTES

Para los pedidos a entregar en la península que no superen los 80€, se cargarán 6,50 € de portes. Para otros destinos consultar con fábrica o comercial.

# ACTUALIZACIÓN Y MANTENIMIENTO DE LAS COLECCIONES

## CAMBIOS EN EL MODELAJE

En ciertas ocasiones, algunos de los artículos suministrados por IMEX PRODUCTS, S.L., pueden presentar cambios, no sustanciales, en algunos de sus componentes en relación a las fotografías publicadas en catálogo actual.  
IMEX PRODUCTS, S.L. se reserva el derecho de efectuar dichos cambios en su modelaje siempre en aras de una mejora tanto del diseño y funcionalidad del producto, como de sus condiciones de venta.

# CONSEJOS DE LIMPIEZA Y MANTENIMIENTO

En Imex Products aconsejamos que para realizar la limpieza de nuestra grifería, en acabados negro mate o blanco mate, se utilicen productos no abrasivos y con un Ph neutro, evitando, de este modo, dañar las piezas.

Siguiendo las indicaciones o recomendaciones del fabricante del producto, aconsejamos la utilización de bayeta de microfibra en el proceso de limpieza, finalizando con el secado de las piezas. De esta forma conseguiremos alargar la vida de la grifería.

Video demostrativo





IMEX PRODUCTS, S.L.

Pol. Ind. Picassent  
C/ 6 parcela 11  
46220 Picasset (Valencia)- Sapain  
C.I.F.:B-98301732

AT.CLIENT:  
Tel: +34 96 065 12 74  
Tel: +34 96 156 63 87  
Tel: +34 630 402 947

[www.imexproducts.es](http://www.imexproducts.es)



Mails:  
(Pedidos) [imex@imexproducts.es](mailto:imex@imexproducts.es)  
(Consultas) [consultas@imexproducts.es](mailto:consultas@imexproducts.es)  
(Servicio Técnico) [sat@imexproducts.es](mailto:sat@imexproducts.es)  
(Exportación) [export@imexproducts.es](mailto:export@imexproducts.es)