

sanycces

mediterranean design



2022 COLLECTION

Faucets

Grifería

Robinetterie

sanycces
faucets collection

index

	p.
Intro	3
<hr/>	
Products	
<hr/>	
Loop / Loop K	26
<hr/>	
Cubo	133
<hr/>	
Air	181
<hr/>	
Project	195
<hr/>	
Shower accessories	205
<hr/>	
Kitchen faucets	219
<hr/>	
Showroom displays	227
<hr/>	
Spare parts	237
<hr/>	
Certificates	253
<hr/>	
Warranty	257
<hr/>	

sanycces

We are water

Somos agua

Nous sommes l'eau

El agua sostiene la vida en la tierra, forma parte de nosotros, literalmente. El agua viaja a través del planeta, transformándose, cambiando de estado... Fluye hasta los océanos, sube al cielo para volar en forma de nube, rugie en tormentas y cae a la superficie de nuevo para volver a empezar y por el camino, sacia nuestra sed, alimenta nuestras cosechas, produce energía y convierte el planeta en nuestro hogar.

Damos por hecho un gesto cotidiano: abrir el grifo y tener agua, además templada. Pero detrás de este gesto casi mecánico se esconde una red de soluciones técnicas que garantiza el suministro, la salubridad y el confort.

Desde Sanycces ofrecemos soluciones y diseños de griferías que ayudan al usuario a interactuar con el agua de forma segura, intuitiva, sostenible y consciente.

Water sustains life on earth, it is part of us, literally. Water travels across the planet, transforming itself, changing its state... It flows to the oceans, rises to the sky to fly as a cloud, roars in storms and falls to surface again to start over and along the way, it quenches our thirst, feeds our crops, produces energy and makes the planet our home.

We take for granted a daily gesture: turning on the tap and having water, which is also warm. But behind this almost mechanical gesture lies a network of technical solutions that guarantee supply, health and comfort.

At Sanycces we offer solutions and designs of faucets that help the user to interact with water in a safe, intuitive, sustainable and conscious way.

L'eau permet la vie sur terre, elle fait partie de nous, littéralement. L'eau voyage à travers la planète, se transforme, change d'état... Elle coule vers les océans, s'élève vers le ciel pour s'envoler comme un nuage, rugit dans les tempêtes et retombe sur la superficie pour recommencer, et en cours de route, elle étanche notre soif, nourrit nos cultures, produit de l'énergie et fait de la planète notre foyer.

Nous tenons pour acquis un geste quotidien : ouvrir le robinet pour avoir de l'eau, qui en plus peut être chaude. Mais derrière ce geste presque mécanique se cache un réseau de solutions techniques qui garantissent l'approvisionnement, la salubrité et le confort.

Chez Sanycces, nous proposons des solutions et des modèles de robinets qui aident les utilisateurs à interagir avec l'eau de manière sûre, intuitive, durable et consciente.

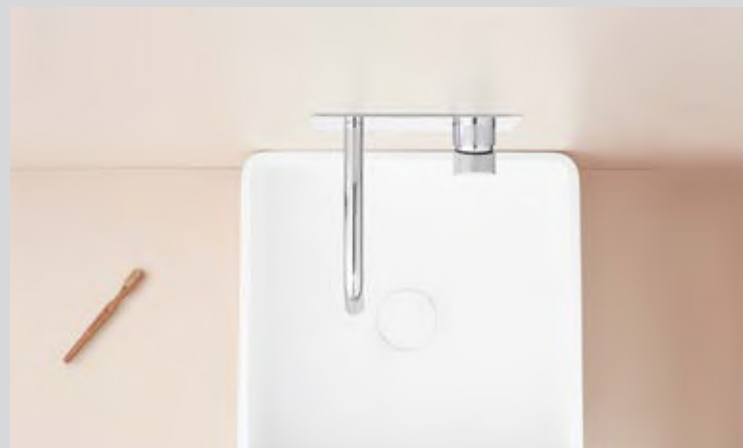

Basamos nuestra colección de griferías en la oferta de lo esencial, con una amplia variedad de acabados y un sinfín de combinaciones, para aportar personalidad y adecuar tu entorno a tu gusto e imagen.

We base our collection of faucets on offering the essential, with a wide variety of finishes and endless combinations, to provide personality and adapt your environment to your taste and image.

Made to fit your skin

Tu piel a medida

Votre peau sur mesure

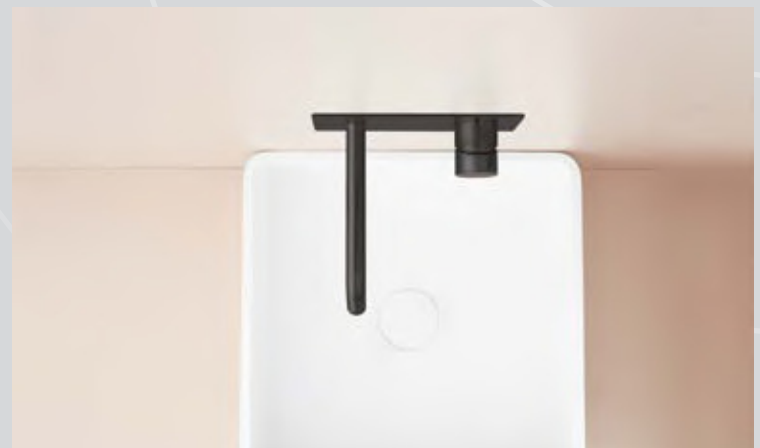
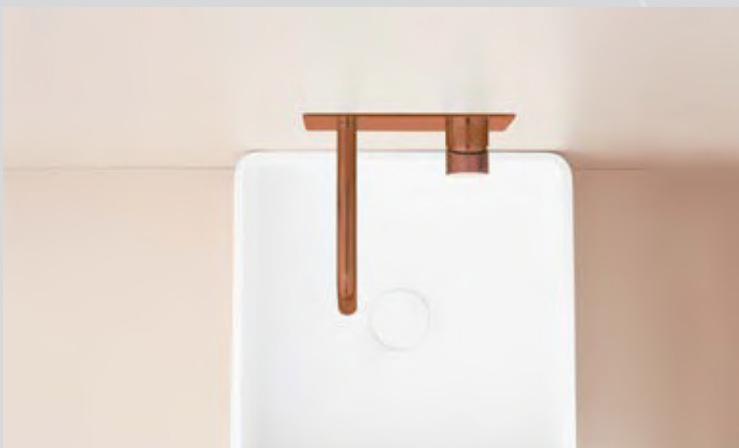

Notre collection de robinets se base sur l'essentiel, avec une grande variété de finitions et des combinaisons infinies, pour donner de la personnalité et adapter votre environnement à votre goût et à votre image.

Take care of you and water

Cuida de ti y del agua

Prenez soin de vous et de l'eau

El agua estimula nuestros sentidos y produce placer. Está cargada de movimiento, llena de vida. Así lo demuestra el mapa de su superficie.

El agua nos cuida y le debemos reciprocidad, por ello apostamos por soluciones que minimizan el consumo de agua y energía.

Water stimulates our senses and produces pleasure. It is charged with movement, full of life. This is demonstrated by the map on your surface.

Water takes care of us and we owe it reciprocity, so we are committed to solutions that minimize water and energy consumption.

L'eau stimule nos sens et produit du plaisir. Elle est chargée de mouvement, pleine de vie. C'est ce que montre la carte de sa superficie.

L'eau prend soin de nous et nous lui devons la réciprocité, c'est pourquoi nous sommes engagés à trouver des solutions qui minimisent la consommation d'eau et d'énergie.

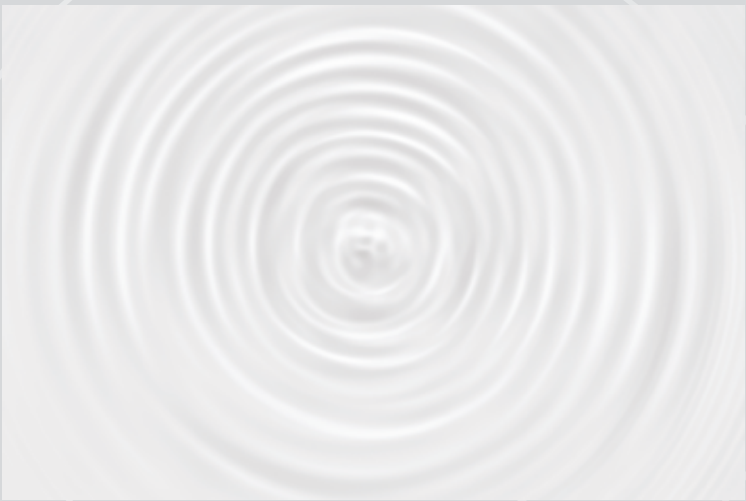

The background of the page features several concentric, thin white circles centered on the page, creating a ripple effect. The text is centered within these circles.

LET YOUR
ESSENCE
FLOW

Deja fluir tu esencia.

Laissez couler votre **essence**.



- 1. Loop / Loop K
- 2. Cubo
- 3. Air

Know-how

Empleamos materias primas de alta calidad que transformamos con tecnología de última generación, para ofrecer un producto que resume lo mejor de lo que somos: Calidad, Eficacia, Servicio con un diseño democrático a la vez que honesto.

Empleamos latón calidad **4MS**. Desde el moldeo por gravedad hasta la línea de embalaje contamos con equipamiento que garantiza la alta calidad de nuestros productos.

Trabajamos con componentes de reconocidos fabricantes que aseguran la funcionalidad del producto a largo plazo.

We use high quality raw materials that we transform with the latest technology, to offer a product that summarizes the best of what we are: Quality, Efficiency, Service with a democratic design while honest.

We use **4MS** quality brass, from the gravity molding to the packaging line we have equipment that guarantees the high quality of our products.

We work with components from recognized manufacturers that ensure the functionality of the product in the long term.

Nous utilisons des matières premières de haute qualité que nous transformons avec les dernières technologies, pour offrir un produit qui résume le meilleur de ce que nous sommes: Qualité, Efficacité, Service avec un design démocratique et honnête à la fois.

Nous utilisons du laiton de qualité **4MS**, depuis le moulage par gravité jusqu'à la chaîne d'emballage; nous disposons d'équipements qui garantissent la haute qualité de nos produits.

Nous travaillons avec des composants provenant de fabricants reconnus qui garantissent la durabilité et la fonctionnalité du produit à long terme.





Testing

Ensayos

Essais



Estanqueidad.

Cada grifo pasa 4 tests de estanqueidad antes del embalaje.

Leakage test.

Every faucet passes 4 times leakage test before packing.

Étanchéité.

Chaque robinet passe 4 tests d'étanchéité avant d'être emballé.



Corrosión.

Ensayo de 200 horas en cámara de niebla salina, de acuerdo a norma EN 248.

Corrosion test.

Corrosion 200 hour test in salt spray chamber, according to EN 248 standard.

Corrosion

Test de corrosion en chambre de brouillard salin sur 200 heures selon la norme EN 248.



Resistencia mecánica.

Más de 200.000 ciclos de apertura y mantienen la sensación de suavidad y calidad en la mano de acuerdo a norma EN 200.

Endurance test.

More than 200,000 opening cycles, maintaining the sensation of softness and quality in the hand, according to EN 200.

Résistance mécanique.

Plus de 200.000 cycles d'ouverture et maintient la sensation de douceur et de qualité dans la main selon la norme EN 200.



Resistencia al desgaste.

Espesores precisos de recubrimiento que son difíciles de erosionar y desgastar.

Wear resistance test.

Precise coating thicknesses that are difficult to erode and wear out.

Résistance à l'usure.

Épaisseurs de revêtement précises, difficiles à éroder et à user.



Ensayo de tracción.

Verificamos que las manetas no se desmontan bajo sobreesfuerzos.

Tensile test.

We verify that the levers do not disassemble under over-exertion.

Essai de traction.

Nous vérifions que les leviers ne se désassemblent pas sous l'effet d'un effort excessif.



Sensibilidad a la temperatura.

Ensayamos con variaciones en la presión y la temperatura del agua para verificar la sensibilidad de los cartuchos.

Temperature sensitivity test.

We test with variations in water pressure and temperature to verify the sensitivity of the cartridges.

Sensibilité à la température.

Nous effectuons des tests avec des variations de pression et de température de l'eau pour vérifier la sensibilité des cartouches.



Precisión.

Cada componente se verifica dimensionalmente para controlar la precisión y ofrecer el mejor rendimiento mecánico.

Precision checks.

Each component is dimensionally verified to control accuracy and provide the best mechanical performance.

Précision.

Chaque composant fait l'objet d'un contrôle dimensionnel pour en vérifier la précision et offrir les meilleures prestations mécaniques.



Cold Open

Apostamos por el sistema de apertura en frío, **Cold Open**, en los monomandos de lavabo como muestra de nuestro compromiso con el ahorro de energía y preservación del medioambiente. En posición centrada el grifo suministra agua fría, es necesaria una ligera rotación a la izquierda para suministrar agua templada, haciendo así consciente al usuario del empleo de energía según sus preferencias.

We bet on the **Cold Open** system, in the single-lever basin mixers as a sign of our commitment to energy saving and environmental preservation. In the central position the tap supplies cold water, a slight rotation to the left is necessary to supply warm water, thus making the user aware of the use of energy according to his preferences.

Nous avons misé sur le système d'ouverture à froid, **Cold Open**, dans les mitigeurs de lavabo comme signe de notre engagement en faveur des économies d'énergie et de la préservation de l'environnement. En position centrale, le robinet fournit de l'eau froide, une légère rotation vers la gauche est nécessaire pour fournir de l'eau chaude, rendant ainsi l'utilisateur conscient de l'utilisation de l'énergie selon ses préférences.



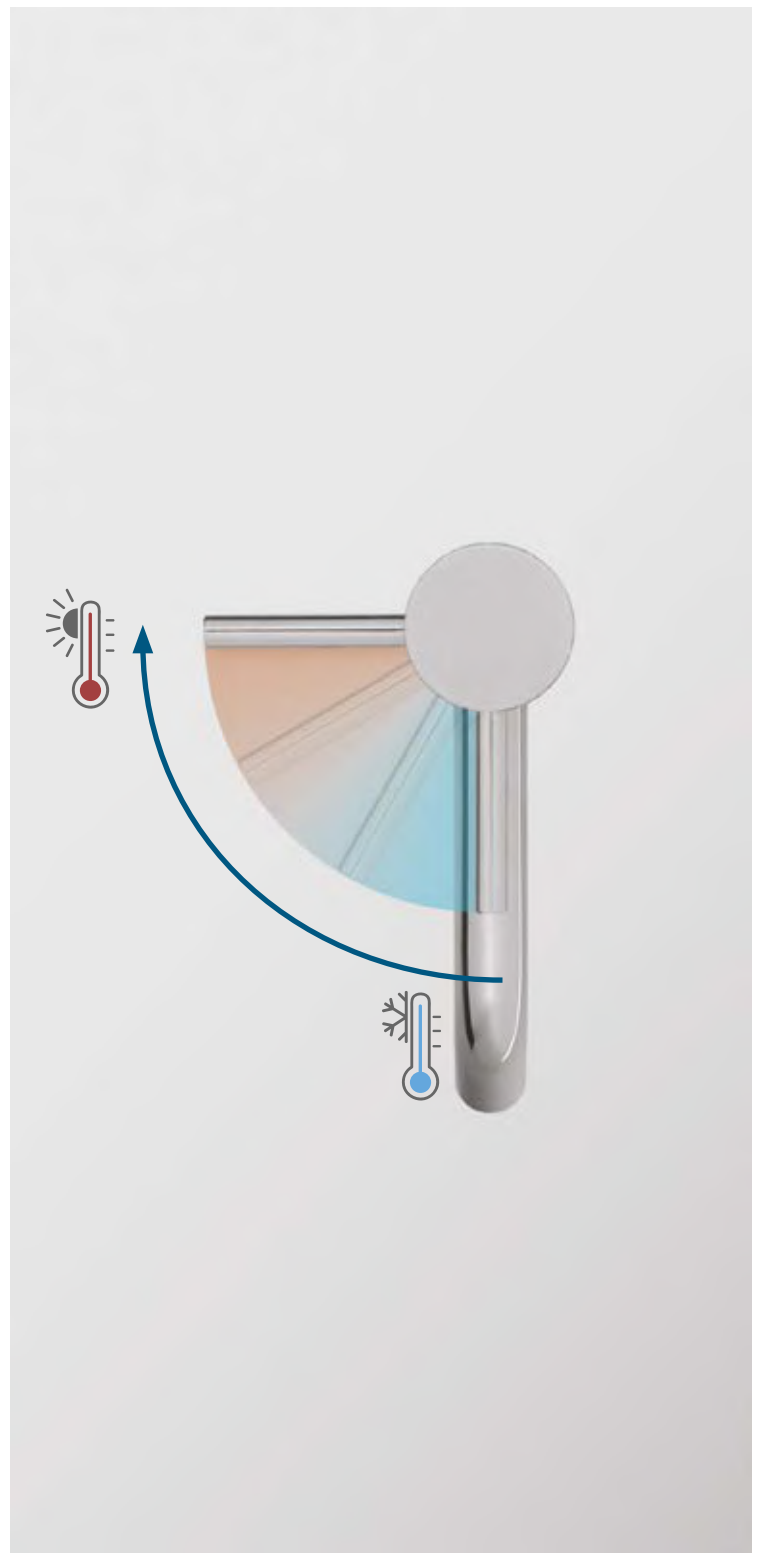

Safe Touch

Nuestras griferías termostáticas para la ducha cuentan con cuerpo **Safe Touch**. El agua caliente pasa directamente al cartucho termostático, el cual se localiza a la izquierda para minimizar el recorrido de la misma. El agua fría envuelve todo el perímetro exterior del cuerpo. Con esto la temperatura de la superficie de contacto se mantiene en valores seguros sin riesgo de quemaduras.

1. Toma de agua caliente.
2. Toma de agua fría.
3. Escudo de agua fría.
4. Superficie fría.
5. Cartucho termostático.
6. Agua mezclada.
7. Cavidad agua mezclada.
8. Cartucho desviador.

Our thermostatic shower faucets have a **Safe Touch** body. The hot water goes directly to the thermostatic cartridge, which is located on the left side to minimize the water flow. The cold water wraps around the entire outer perimeter of the body. With this, the contact temperature of the surface of the faucet is maintained at safe values without the risk of burns.

1. Hot water inlet.
2. Cold water inlet.
3. Cold body shelter.
4. Cold tap surface.
5. Thermostatic cartridge.
6. Mixed water.
7. Core mixed water cavity.
8. Diverter cartridge.

Nos robinets de douche thermostatiques ont un corps froid **Safe Touch**. L'eau chaude va directement à la cartouche thermostatique, qui est située sur le côté gauche pour minimiser le débit d'eau. L'eau froide recouvre tout le périmètre extérieur du corps. Ainsi, la température de contact de la surface du robinet est maintenue à des valeurs sûres sans risque de brûlures.

1. Entrée d'eau chaude
2. Entrée d'eau froide
3. Cavité pour le corps froid.
4. Corps froid.
5. Cartouche thermostatique.
6. Mélange d'eau.
7. Corps de mélange.
8. Cartouche de dérivation.

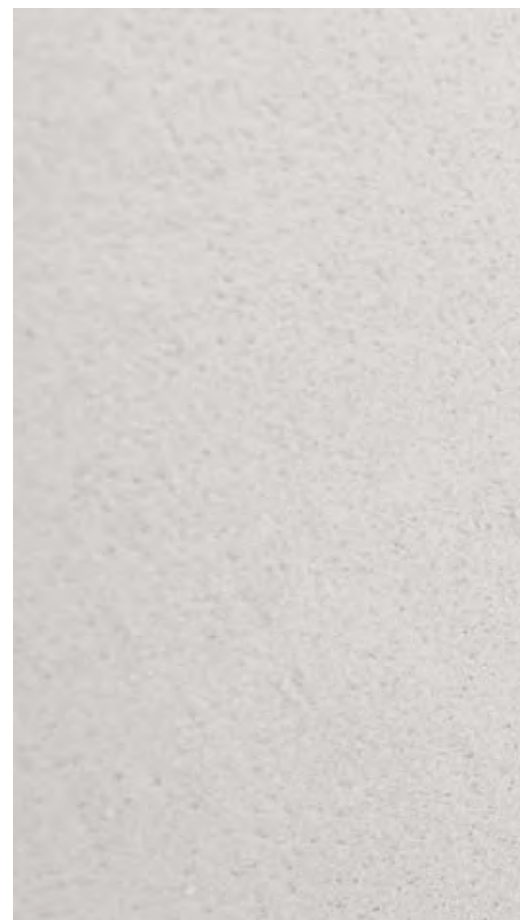

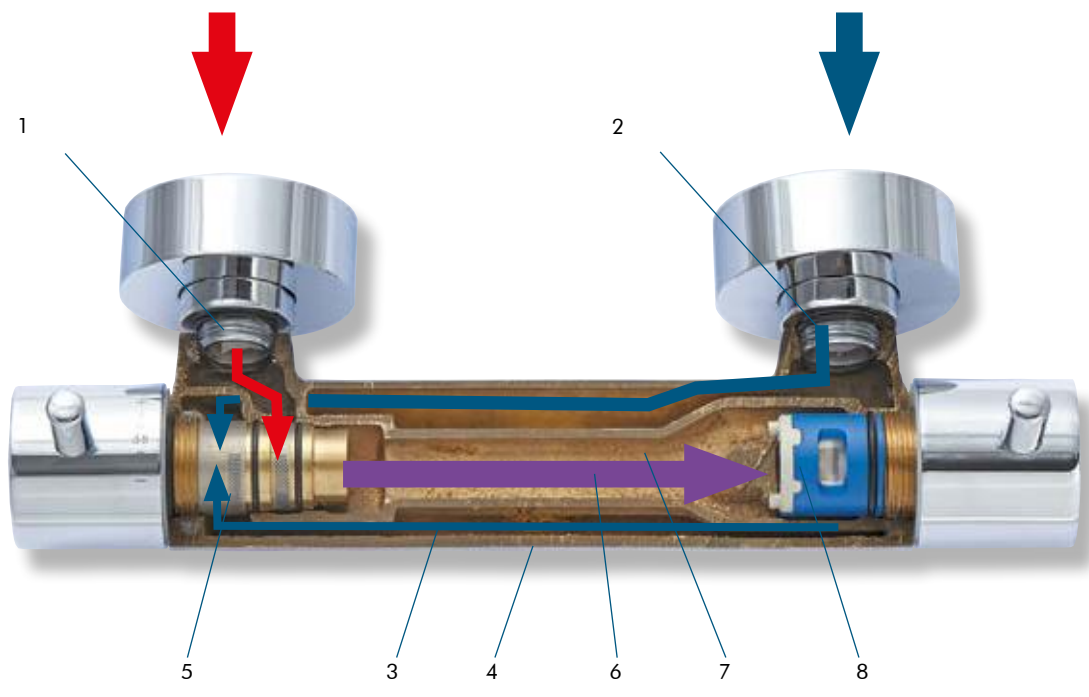

1

sanybox



2

Series



sanybox

Los cuerpos de empotrar **sanybox** son universales e independientes de la parte vista, se puede instalar cualquier serie en cualquier acabado en un mismo cuerpo de empotrar.

The **sanybox** concealed bodies are universal and independent of the exposed part, any series can be installed in any finish in the same concealed body.

Les corps encastrables **sanybox** sont universels et indépendants de la partie exposée, tous les séries peuvent être installées dans le même corps encastrable, peu importe la finition.

3 finishes



CR
Cromo brillo
Chrome plate
Chrome



BM
Negro mate
Black matt
Noir mat



MG
Metal gun
Metal gun
Metal gun



NB
Níquel cepillado
Nickel brushed
Nickel brossé



BG
Oro cepillado
Brushed gold
Or brossé



RG
Oro rosa cepillado
Brushed rose gold
Or rose brossé

One finish for each style

Un acabado para cada estilo

Une finition pour chaque style

Nuevos acabados atemporales que aportan el toque de valor en cualquier estilo de interiorismo.

New timeless finishes that add a touch of value to any interior design style.

De nouvelles finitions intemporelles qui apportent la touche finale à tout style de décoration intérieure.



CR

El cromo brillo es bello, fácilmente combinable y atemporal. El proceso de cromado asegura unos espesores de níquel y cromo uniformes que garantizan la resistencia del producto a la corrosión además de un brillo y suavidad insuperables.

Chrome plate is beautiful, easily combined and timeless. The chrome-plating process ensures uniform nickel and chrome thicknesses that guarantee the product's resistance to corrosion as well as unsurpassed shine and softness.

Le chrome brillant est beau, facile à combiner et intemporel. Le procédé de chromage assure des épaisseurs uniformes de nickel et de chrome qui garantissent la résistance du produit à la corrosion ainsi qu'une brillance et une douceur inégalées.



BM

Negro mate, un acabado básico y versátil en múltiples estilos. Sedoso, oscuro, profundo. El recubrimiento electrolítico garantiza la durabilidad del color y su adherencia al soporte.

Matt black, a basic and versatile finish in multiple styles. Silky, dark, deep. The electrolytic coating guarantees the durability of the color and its adherence to the support.

Noir mat, une finition basique et polyvalente dans de multiples styles. Soyeux, sombre, profond. Le revêtement électrolytique garantit la durabilité de la couleur et son adhérence au support.



MG

Metal gun, este acabado cepillado en color gris oscuro resulta contundente, industrial, masculino... Este acabado se fabrica mediante la misma técnica PVD que se emplea para recubrir las puntas de las brocas de taladrar, consiguiendo con ello un color perdurable en el tiempo.

Metal gun, this brushed finish in dark gray color is forceful, industrial, masculine... This finish is manufactured using the same PVD technique used to coat the tips of the drill bits, thus achieving a lasting color over time.

Metal Gun, cette finition brossée de couleur gris foncé est saisissante, industrielle, masculine... Cette finition est fabriquée selon la même technique PVD que celle utilisée pour revêtir les pointes des mèches de forage, ce qui permet d'obtenir une couleur durable.



NB

Níquel cepillado, acabado minimalista, atemporal y sobrio, perfecto para combinar con acero inoxidable. También fabricado mediante técnica PVD.

Brushed nickel, minimalist finish, timeless and sober, perfect to combine with stainless steel. Also manufactured by PVD technique.

Nickel brossé, finition minimaliste, intemporelle et sobre, parfaite pour se combiner avec l'acier inoxydable. Également fabriqué selon la technique PVD.



BG

Oro cepillado, un color oro de 18K sofisticado a la vez que contenido. Se convierte en pieza de acento, protagonista en cualquier composición. Fabricado mediante técnica PVD.

Brushed gold, a sophisticated yet contained 18K gold color. It becomes an accent piece, a protagonist in any composition. Manufactured using PVD technique.

L'or brossé, une couleur d'or 18K sophistiquée mais contenue. Elle devient une pièce d'accent, un protagoniste dans chaque composition. Fabriqué en utilisant la technique PVD.



RG

Oro rosa cepillado, un acabado de tendencia con brillos rojizos que transmite estilo propio y elegancia. Por supuesto, fabricado mediante técnica PVD.

Brushed pink gold, a trendy finish with reddish glitter that transmits style and elegance. Of course, made by PVD technique.

L'or rose brossé, une finition tendance avec des reflets rougissants qui transmet style et élégance. Bien sûr, réalisé par la technique PVD.

Premium surfaces PVD

Superficies premium PVD

Surfaces premium PVD

Los acabados PVD cuentan con una película adicional que facilita el mantenimiento y limpieza de las griferías ya que repele las gotas de agua.

The PVD finishes have an additional film that facilitates the maintenance and cleaning of the faucets because it repels water drops.

Les finitions PVD comportent un film supplémentaire qui facilite l'entretien et le nettoyage des robinets car il repousse les gouttes d'eau.



Details that matter

Superficies premium

Surfaces premium

Flexos de PVC, material de fácil limpieza con sistema anti-torsión, para que la rutina de la ducha no se convierta en una pelea con el flexo para mantener la posición deseada de la teleducha.

PVC hoses, easy to clean material with anti-twist system, so that the shower routine does not become a fight with hose to maintain the desired position of the hand shower.

Tuyaux en PVC, matériau facile à nettoyer avec système anti-torsion, afin que la routine de la douche ne devienne pas une lutte avec le tuyau pour maintenir la position souhaitée de la douchette.



Todos los soportes de teleducha se han diseñado con una pieza envolvente de ABS para proporcionar un asiento suave a la teleducha y prevenir las rayas que aparecen en el contacto entre metales.

All hand shower supports have been designed with an ABS coated piece to provide a soft seat for the hand shower and prevent scratches that appear on contact between metals.

Tous les supports de douche à main ont été conçus avec une pièce revêtue d'ABS afin de fournir un siège souple pour la douche à main et d'éviter les rayures qui apparaissent au contact des métaux.



Loop



Loop K



Loop

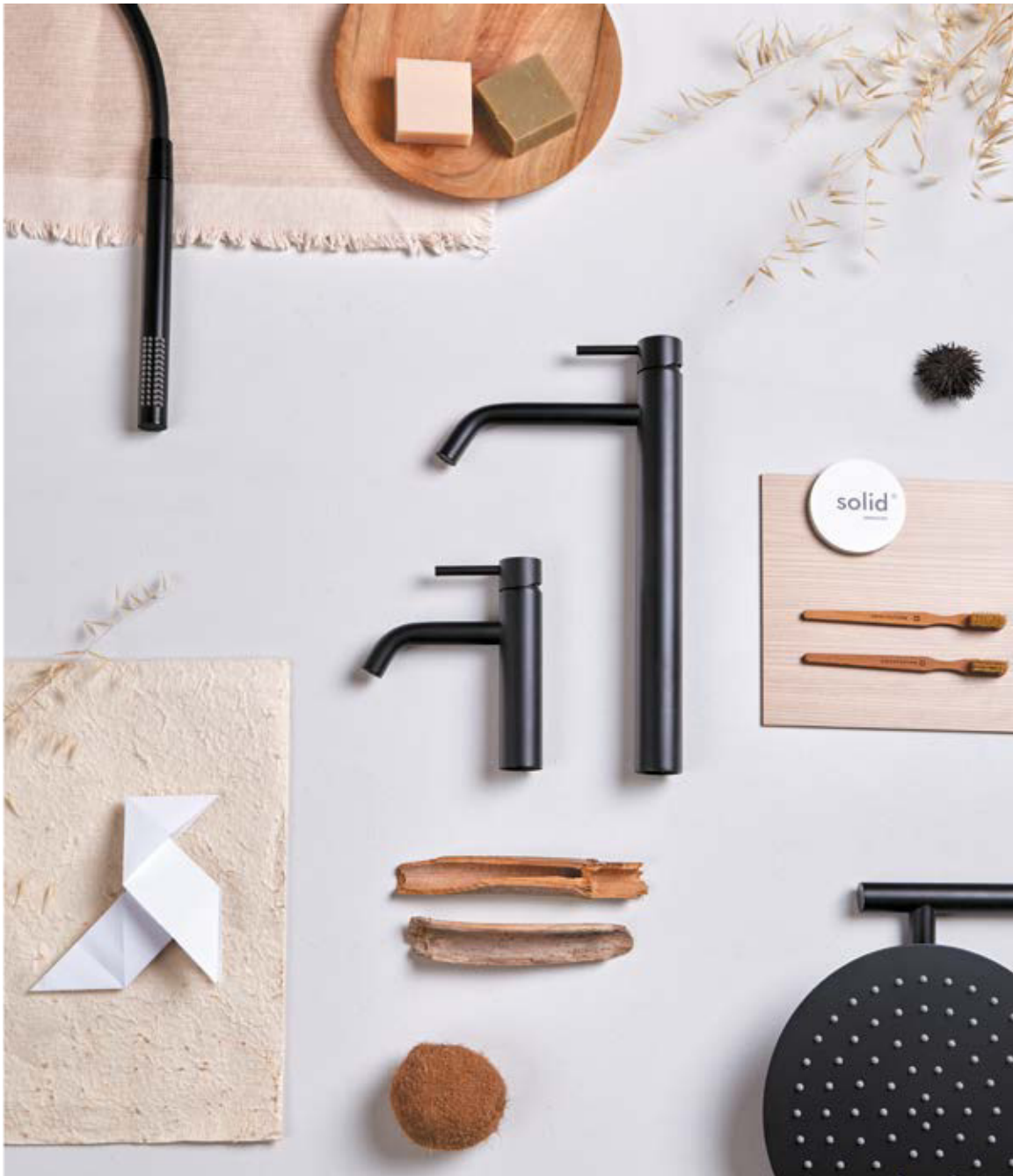

Negro mate, un acabado básico y versátil en múltiples estilos. Sedoso, oscuro, profundo. Asimilable a Oriente, minimalismo con contrastes, elegancia clásica.

En página contigua, níquel cepillado, puro y minimalista, atemporal y sobrio, perfecto para combinar con acero inoxidable.

Black matt, a basic and versatile finish in multiple styles. Velvety, dark, deep. Similarly to the Orient, minimalism with contrasts, classic elegance.

On the next page, brushed nickel, pure and minimalist, timeless and sober, perfect to be combined with stainless steel.

Noir mat, une touche basique et versatile dans plusieurs styles. Soyeux, foncé, intense. Similaire à l'Orient, un minimalisme contrastant, une élégance classique.

Sur la page suivante, nickel brossé, pure et minimaliste, intemporel et sobre, parfait pour combiner avec l'acier inoxydable.



Loop



Loop K



En página anterior oro rosa cepillado, un acabado de tendencia con brillos rojizos que transmite estilo propio. Son piezas que resaltan en cualquier entorno y atraen todas las miradas.

On the previous page, brushed rose gold, a trendy finish with reddish sheen that transmits its own style. These pieces highlight in any environment and attract all eyes.

Sur la page précédente or rose brossé, une touche finale très actuelle, avec un éclat rougeâtre, qui transmet son propre style. Ce sont des pièces qui se distinguent dans n'importe quel espace et attirent tous les regards.

Sobre estas líneas oro cepillado, un color oro de 18K sofisticado a la vez que contenido. Se convierte en pieza de acento, protagonista en cualquier composición cual elemento de joyería.

On these lines, brushed gold, an 18K gold colour sophisticated and at the same time contained. It becomes an accent piece, protagonist in any composition as a jewellery element.

Sur ces lignes l'or brossé, une couleur d'or 18K sophistiquée mais sobre. Elle se convertit en une pièce de caractère, protagoniste dans toutes les compositions telle qu'une pièce de bijouterie.

Loop

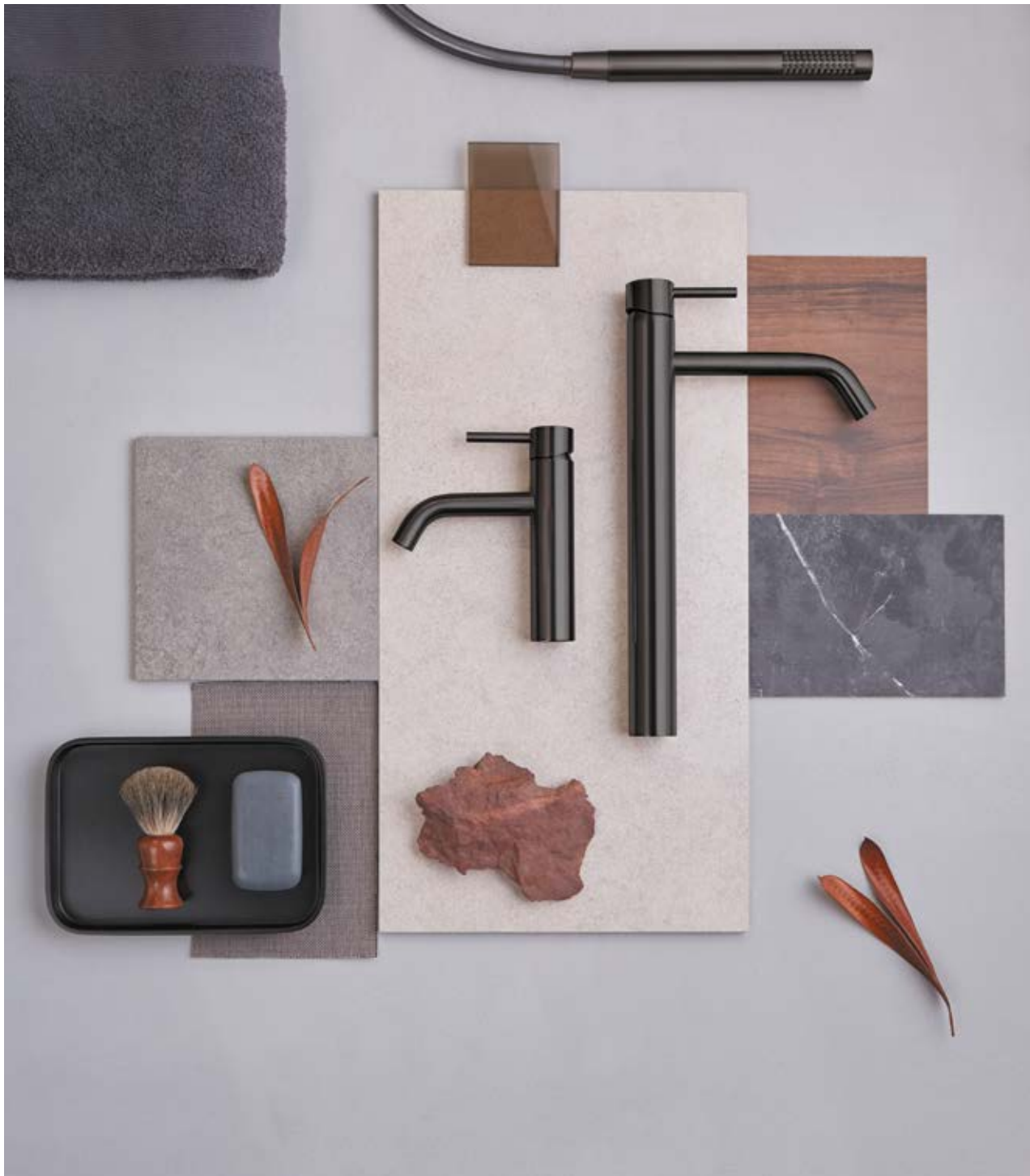

Loop K



Metal gun, este acabado cepillado en color gris oscuro resulta contundente, industrial y masculino a la vez que sofisticado y moderno.

Metal gun, this brushed finish in dark grey results in strong, industrial and masculine as well as sophisticated and modern.

Metal gun, cette finition brossée en gris foncé résulte contundante, industrielle et masculine ainsi que sophistiquée et moderne.

Loop





Loop K





MNO011NB
Nickel Brushed

Loop

MEN001R18CR
Chrome
MEN000

Loop K

MEN011S18MGMG
Metal Gun
MEN000



Loop K



Monomando
Single lever
Mitigeur



Loop



- BAR00170BG
- TEL001BG
- FLE010BG
- TOM001BG
- ME1001BG
- Brushed Gold
- ME1000

Loop



Monomando
Single lever
Mitigeur

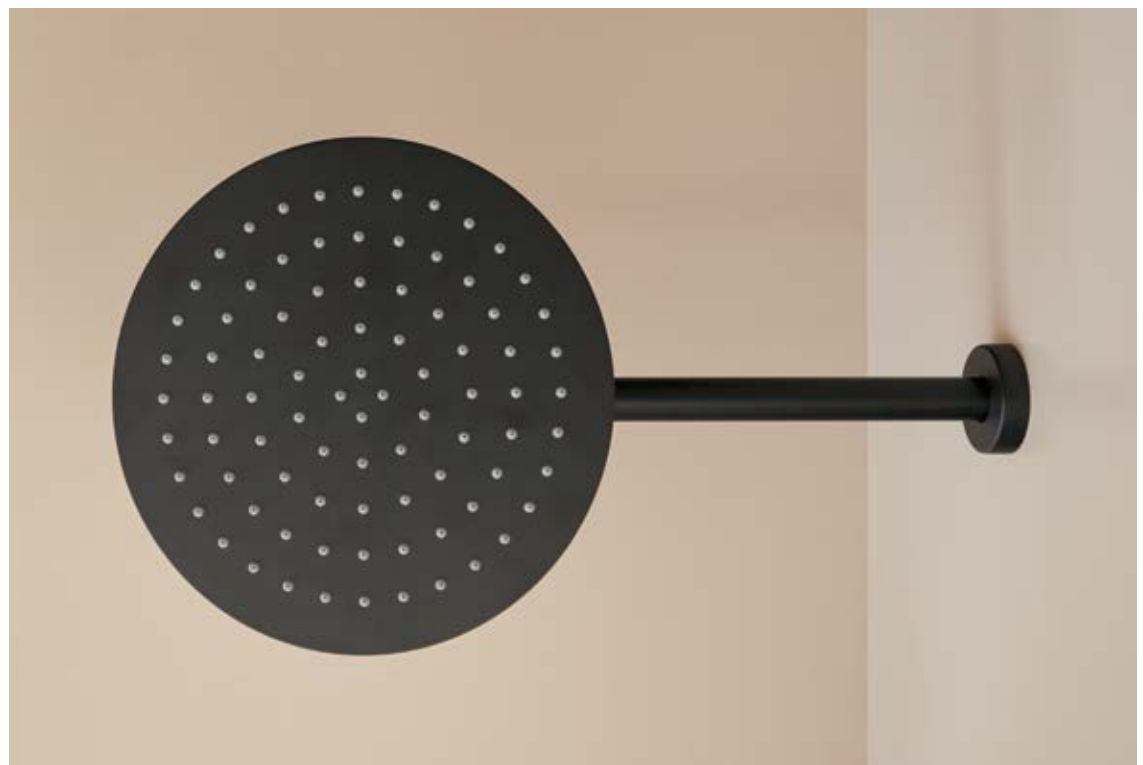



ROC001BM
BRP00140BM
TEL001BM
FLE010BM
STM001BM
ME2001BM
Black Matt
ME2000

Loop



Termostática
Thermostatic mixer
Thermostatique



T13001BM
Black Matt
TE1000/TE3000



TEL001BM
FLE010BM
STM001BM
Black Matt



Loop





MH2D001BG
Brushed Gold
MH2000

Loop K



Progressiva
Progressive
Progressive





BNEX011BGBG
Brushed Gold

Loop



Termostática
Thermostatic mixer
Thermostatique





COTE001RG
Brushed Rose Gold

Loop



Monomando
Single lever
Mitigeur





COMO001NB
Nickel Brushed

Loop



Progressiva
Progressive
Progressive





BNACC205
Black matt



Loop



Monomando
Single lever
Mitigeur





BNCA001BG
MH2D001BG
Brushed Gold
MH2000

Loop



Monomando
Single lever
Mitigeur

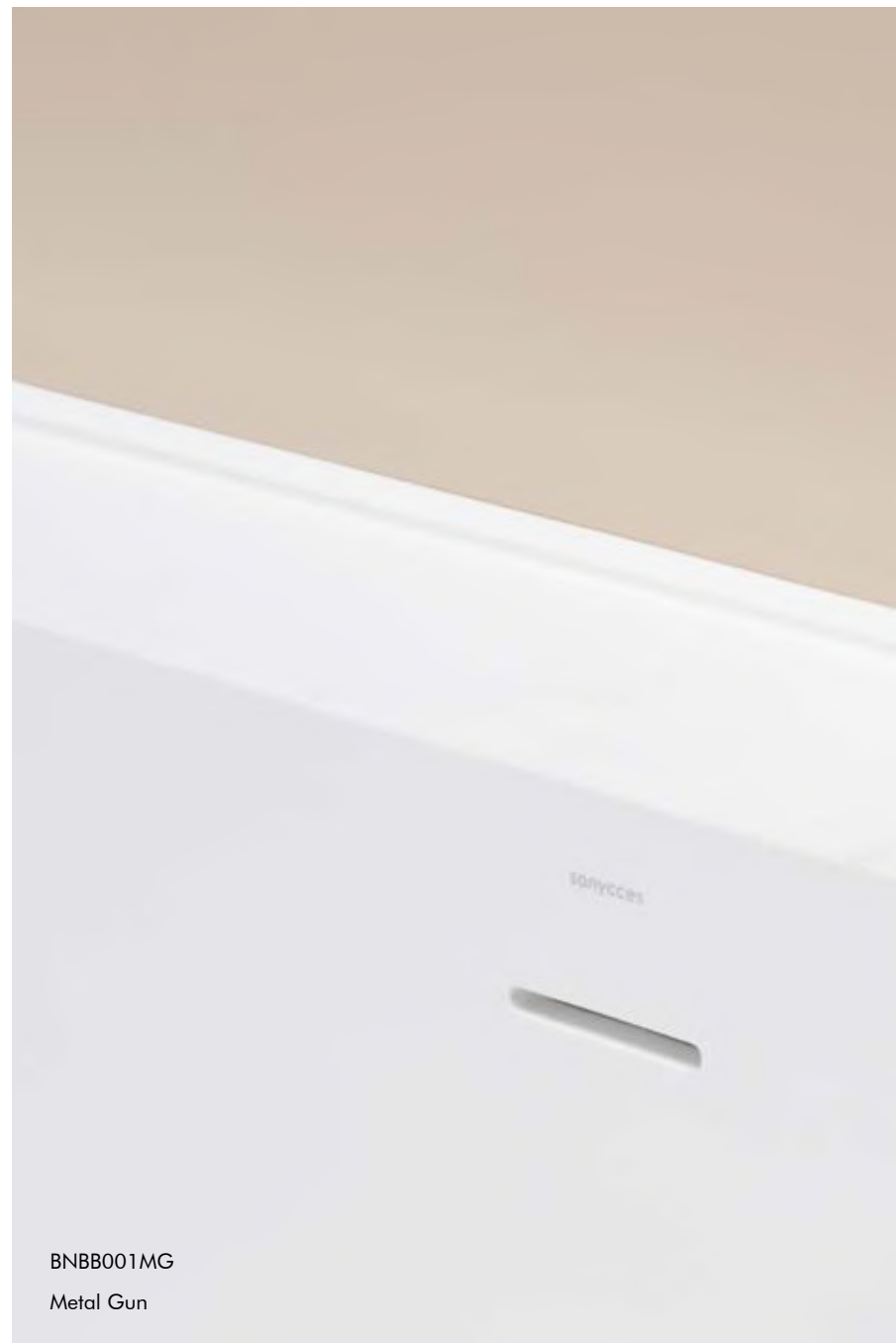

BNBB001MG
Metal Gun



Loop K



MNO011NBBG

Nickel Brushed-Brushed Gold

MOA011MGRG

Metal Gun-Brushed Rose Gold

MNO011BGMG

Brushed Gold-Metal Gun

Mix & Match

Estilo propio, con Loop K combina diferentes acabados en una pieza. La maneta moleteada aporta textura y énfasis. Todas las combinaciones están disponibles, simplemente elige la que mejor defina tu estilo.

Own style, with Loop K combines different finishes in a single piece. The knurled handle adds texture and emphasis. All combinations are available, simply choose the one that best defines your style.

Style unique, avec Loop K combinez différentes techniques de finition en une seule pièce. Le poignée moletée donne de la texture et de l'émphase. Toutes les combinaisons sont disponibles, choisissez simplement celle qui définit le mieux votre style.

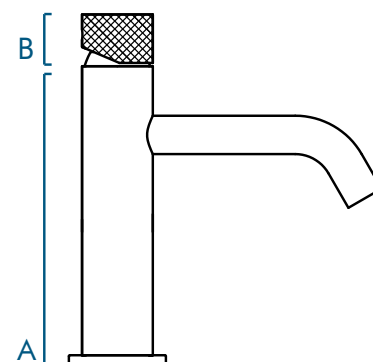

CR
Cromo brillo
Chrome plate
Chrome



BM
Negro mate
Black matt
Noir mat



MG
Metal gun
Metal gun
Metal gun



NB
Niquel cepillado
Nickel brushed
Nickel brossé



BG
Oro cepillado
Brushed gold
Or brossé



RG
Oro rosa cepillado
Brushed rose gold
Or rose brossé

Loop



Monomando de lavabo
Basin mixer
Mitigeur de lavabo
p. 67



Monomando alto de lavabo
High basin mixer
Mitigeur haut de lavabo
p. 67



Monomando de bidé
Bidet mixer
Mitigeur de bidet
p. 67



Monomando exento de lavabo
Freestanding basin mixer
Mitigeur sur pied de lavabo
p. 71



Monomando de lavabo mural
Wall-mounted basin mixer
Mitigeur de lavabo mural
p. 69



sanybox para monomando de lavabo mural
Wall-mounted basin mixer **sanybox**
sanybox pour mitigeur de lavabo mural
p. 69



Grifería de pie para bañera
Freestanding faucet for bathtub
Robinetterie sur pied pour baignoire
p. 71



Monomando borde bañera
Deck mounted mixer for bathtub
Mitigeur au bord pour baignoire
p. 73



Caño de bañera mural
Wall-mounted bathtub spout
Canon mural pour baignoire
p. 75



Monomando de ducha mural horizontal de 2 vías
Wall-mounted shower mixer 2 ways
Mitigeur de douche mural 2 voies
p. 75



sanybox para monomando horizontal 2 vías mural
Horizontal wall-mounted mixer 2 ways **sanybox**
sanybox pour mitigeur horizontal 2 voies mural
p. 75



Monomando exterior para ducha
Exposed shower mixer
Mitigeur de douche exterieur
p. 77



Monomando exterior para baño-
ducha
Exposed bath-shower mixer
Mitigeur de bain-douche exterieur
p. 77



Columna de ducha monomando
Mixer shower column
Colonne de douche mitigeur
p. 77



Termostático exterior para ducha
Exposed shower thermostatic mixer
Thermostatique de douche exterieur
p. 79



Termostático exterior para baño-
ducha
Exposed bath-shower thermostatic
mixer
Thermostatique de bain-douche
exterieur
p. 79



Columna de ducha termostática
Thermostatic shower column
Colonne de douche
thermostatique
p. 79



Monomando de ducha mural
horizontal de 2 vías
Wall-mounted shower mixer 2 ways
Mitigeur de douche mural 2 voies
p. 81



sanybox para monomando
horizontal 2 vías mural
Horizontal wall-mounted mixer 2
ways **sanybox**
sanybox pour mitigeur horizontal 2
voies mural
p. 81



Monomando para bidé-WC
mural
Wall-mounted bidet-WC mixer
Mitigeur bidet-WC mural
p. 81

Loop



Loop kit monomando mural ducha rociador + teleducha

Loop kit wall-mounted shower mixer showerhead + handshower

Loop kit mitigeur de douche mural douche de tête + douchette

p. 83

Loop kit termoestático mural ducha rociador + teleducha

Loop kit wall-mounted thermostatic shower mixer showerhead + handshower

Loop kit thermostatique de douche mural douche de tête + douchette

p. 83



Monomando ducha mural 1 vía
Wall-mounted shower mixer 1 way
Mitigeur de douche mural 1 voie

p. 85

sanybox para monomando de ducha mural 1 vía
Wall-mounted shower mixer 1 way **sanybox**

sanybox pour mitigeur de douche mural 1 voie

p. 85

Monomando de ducha mural 2 vías
Wall-mounted shower mixer 2 ways
Mitigeur de douche mural 2 voies

p. 85

sanybox para monomando de ducha mural 2 vías
Wall-mounted shower mixer 2 way **sanybox**

sanybox pour mitigeur de douche mural 2 voies

p. 85



Termoestático de ducha mural 1-2-3 vías

Wall-mounted shower thermostatic mixer 1-2-3 ways

Thermostatique de douche mural 1-2-3 voies

p. 87

sanybox para termoestático de ducha mural 1 vía

Wall-mounted shower thermostatic mixer 1 way **sanybox**

sanybox pour thermostatique de douche mural 1 voie

p. 87

sanybox para termoestático de ducha mural 2-3 vías

Wall-mounted shower thermostatic mixer 2-3 ways **sanybox**

sanybox pour thermostatique de douche mural 2-3 voies

p. 87



Rociador de ducha Ø 25cm
 Ø 25cm shower head
 Douche de tête Ø 25cm
 p. 89



Brazo de ducha mural
 Wall shower arm
 Bras de douche mural
 p. 89



Brazo de ducha a techo
 Ceiling shower arm
 Bras de douche au plafond
 p. 89



Barra de ducha deslizante metálica
 Metal sliding shower bar
 Barre de douche coulissante
 métallique
 p. 91



Teleducha
 Hand shower
 Douchette
 p. 91



Flexo de ducha
 Flexible hose
 Flexible de douche
 p. 91



Soporte de teleducha a pared fijo
 Hand shower fixed wall support
 Support mural fixe pour douchette
 p. 93



Soporte de teleducha a pared orientable
 Hand shower swivel wall support
 Support mural pivotant pour douchette
 p. 93



Soporte de teleducha con toma de agua a pared fijo
 Hand shower fixed wall support with water outlet
 Support mural fixe pour douchette avec sortie
 p. 93



Toma de agua mural
 Wall shower outlet
 Coude de sortie mural
 p. 93

Loop

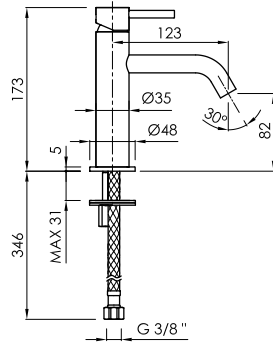

mm



Apertura en frío
Cold open
Ouverture en eau froide



Ahorro de energía
Energy saving
Économie d'énergie



Aireador NEOPERL®
NEOPERL® aerator
Aérateur NEOPERL®



Para válvula click clack
For pop-up waste
Pour bonde click-clack



Caudal a 3 BAR
Flow rate at 3 BAR
Débit à 3 BAR



Cartucho SEDAL®
SEDAL® cartridge
Cartouche SEDAL®



Latiguillos TUCAI®
TUCAI® hoses
Flexible TUCAI®



Válvula no incluida
Waste not included
Bonde non incluse

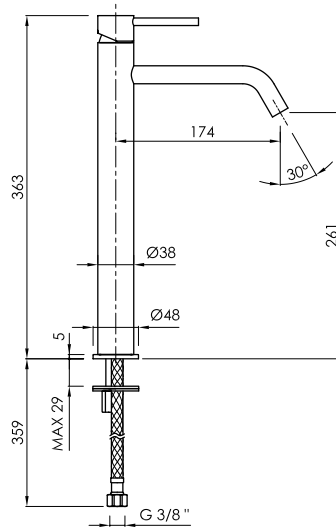

mm



Apertura en frío
Cold open
Ouverture en eau froide



Ahorro de energía
Energy saving
Économie d'énergie



Aireador NEOPERL®
NEOPERL® aerator
Aérateur NEOPERL®



Para válvula click clack
For pop-up waste
Pour bonde click-clack



Caudal a 3 BAR
Flow rate at 3 BAR
Débit à 3 BAR



Cartucho SEDAL®
SEDAL® cartridge
Cartouche SEDAL®



Latiguillos TUCAI®
TUCAI® hoses
Flexible TUCAI®



Válvula no incluida
Waste not included
Bonde non incluse

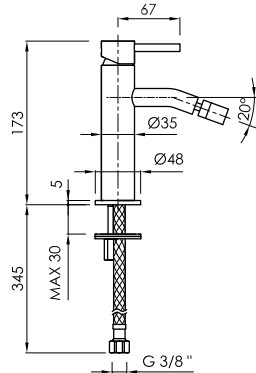

mm



Apertura en frío
Cold open
Ouverture en eau froide



Ahorro de energía
Energy saving
Économie d'énergie



Aireador orientable NEOPERL®
NEOPERL® adjustable aerator
Aérateur réglable NEOPERL®



Para válvula click clack
For pop-up waste
Pour bonde click-clack



Caudal a 3 BAR
Flow rate at 3 BAR
Débit à 3 BAR



Cartucho SEDAL®
SEDAL® cartridge
Cartouche SEDAL®



Latiguillos TUCAI®
TUCAI® hoses
Flexible TUCAI®



Válvula no incluida
Waste not included
Bonde non incluse



Monomando de lavabo / Basin mixer / Mitigeur de lavabo



					
CR	BM	MG	NB	BG	RG
MNO001CR	MNO001BM	MNO001MG	MNO001NB	MNO001BG	MNO001RG
127 €	154 €	198 €	198 €	198 €	198 €

Monomando alto de lavabo / High basin mixer / Mitigeur haut de lavabo

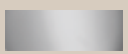
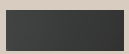
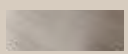

					
CR	BM	MG	NB	BG	RG
MOA001CR	MOA001BM	MOA001MG	MOA001NB	MOA001BG	MOA001RG
204 €	242 €	314 €	314 €	314 €	314 €

Monomando de bidé / Bidet mixer / Mitigeur de bidet



					
CR	BM	MG	NB	BG	RG
MBD001CR	MBD001BM	MBD001MG	MBD001NB	MBD001BG	MBD001RG
132 €	165 €	204 €	204 €	204 €	204 €

Loop

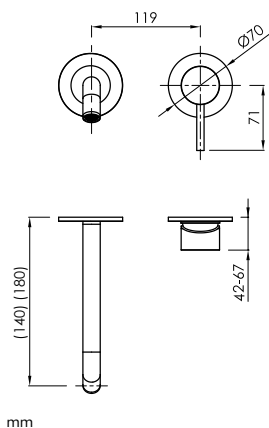

mm



Apertura en frío
Cold open
Ouverture en eau froide



Ahorro de energía
Energy saving
Économie d'énergie



Aireador NEOPERL®
NEOPERL® aerator
Aérateur NEOPERL®



Caudal a 3 BAR
Flow rate at 3 BAR
Débit à 3 BAR



Cartucho KEROX
KEROX cartridge
Cartouche KEROX

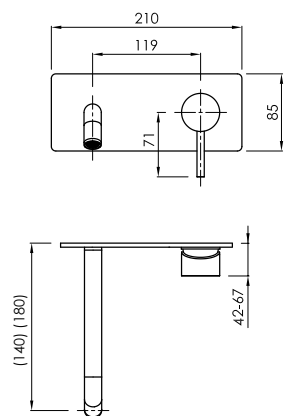

mm



Apertura en frío
Cold open
Ouverture en eau froide



Ahorro de energía
Energy saving
Économie d'énergie



Aireador NEOPERL®
NEOPERL® aerator
Aérateur NEOPERL®



Caudal a 3 BAR
Flow rate at 3 BAR
Débit à 3 BAR



Cartucho KEROX
KEROX cartridge
Cartouche KEROX

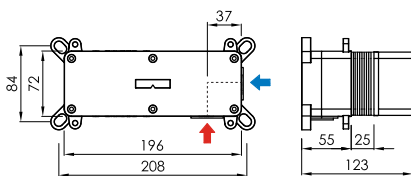

mm



Cuerpo encastre universal
Universal concealed body
Corps d'encastrement universel



Ahorro de energía
Energy saving
Économie d'énergie



Apertura en frío
Cold open
Ouverture en eau froide



Conexiones 1/2" hembra latón
Connections 1/2" female brass
Raccordements 1/2" laiton femelle

Loop

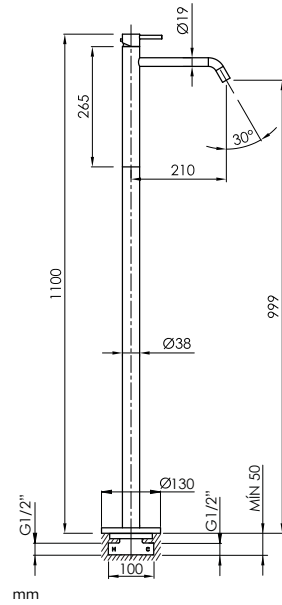

Apertura en frío
Cold open
Ouverture en eau froide



Ahorro de energía
Energy saving
Économie d'énergie



Aireador NEOPERL®
NEOPERL® aerator
Aérateur NEOPERL®



Caudal a 3 BAR
Flow rate at 3 BAR
Débit à 3 BAR



Cartucho SEDAL®
SEDAL® cartridge
Cartouche SEDAL®

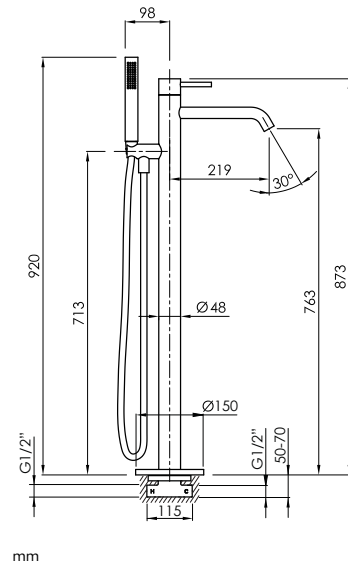

Caudal a 3 BAR
Flow rate at 3 BAR
Débit à 3 BAR



Teleducha de latón
Brass handshower
Douchette à main en laiton



Aireador NEOPERL®
NEOPERL® aerator
Aérateur NEOPERL®



Caudal a 3 BAR
Flow rate at 3 BAR
Débit à 3 BAR



Flexo 1,5m PVC
1,5 m PVC hose
Flexible 1,5m PVC

Monomando exento de lavabo / Freestanding basin mixer / Mitigeur sur pied de lavabo

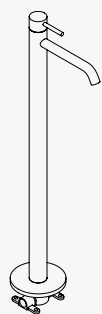

					
CR	BM	MG	NB	BG	RG
MEX001CR	MEX001BM	MEX001MG	MEX001NB	MEX001BG	MEX001RG
567 €	671 €	715 €	715 €	715 €	715 €

Grifería de pie para bañera / Freestanding faucet for bathtub / Robinetterie sur pied pour baignoire

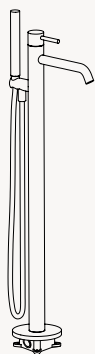

					
CR	BM	MG	NB	BG	RG
BNACC204	BNACC205	BNEX001MG	BNEX001NB	BNEX001BG	BNEX001RG
1.040 €	1.210 €	1.595 €	1.595 €	1.595 €	1.595 €

Loop

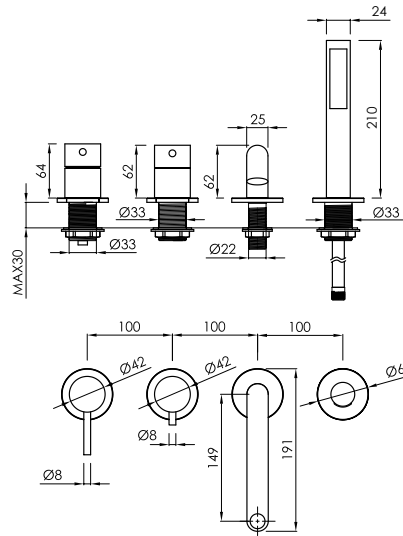

mm



Monomando
Mixer
Mittigeur



Aireador NEOPERL®
NEOPERL® aerator
Aérateur NEOPERL®



Teleducha de latón
Brass handshower
Douchette à main en laiton



Caudal a 3 BAR
Flow rate at 3 BAR
Débit à 3 BAR



Caudal a 3 BAR
Flow rate at 3 BAR
Débit à 3 BAR



Flexo 1,5m
1,5 m hose
Flexible 1,5m

Monomando borde bañera / Deck mounted mixer for bathtub / Mitigeur au bord pour baignoire



					
CR	BM	MG	NB	BG	RG
BNBB001CR	BNBB001BM	BNBB001MG	BNBB001NB	BNBB001BG	BNBB001RG
468 €	528 €	550 €	550 €	550 €	550 €

Caño de bañera mural / Wall-mounted bathtub spout / Canon mural pour baignoire



CR	BM	MG	NB	BG	RG
BNCA001CR	BNCA001BM	BNCA001MG	BNCA001NB	BNCA001BG	BNCA001RG
90 €**	110 €**	130 €**	130 €**	130 €**	130 €**

Monomando ducha mural horizontal de 2 vías / Wall-mounted shower mixer 2 ways / Mitigeur de douche mural 2 voies

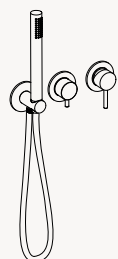

CR	BM	MG	NB	BG	RG
MH2D001CR	MH2D001BM	MH2D001MG	MH2D001NB	MH2D001BG	MH2D001RG
260 €*	320 €*	370 €*	370 €*	370 €*	370 €*

sanybox para monomando horizontal 2 vías mural / Horizontal wall-mounted mixer 2 way sanybox / sanybox pour mitigeur horizontal 2 voies mural

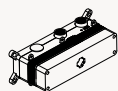

MH2000

230 €

* Las griferías murales contemplan solo la parte externa, el pedido debe acompañarse con el cuerpo de empotrar **sanybox** correspondiente.

* Wall-mounted faucets only include the external part, the order must be accompanied by the corresponding concealed body **sanybox**.

* Les robinets muraux ne sont que pour la partie extérieure, la commande doit être accompagnée du corps encastré **sanybox** correspondant.

** El caño de bañera es independiente de la **sanybox** MH2000. Para crear una batería mural de bañera completa, el caño se puede alimentar de la salida libre de la **sanybox** MH2000.

** The bath spout is independent from the **sanybox** MH2000. To create a complete bathtub wall-mounted battery, the spout can be fed from free outlet of **sanybox** MH2000.

** Le bec de baignoire est indépendant du **sanybox** MH2000. Pour créer un serpentin mural complet de baignoire, le bec peut être alimenté depuis la sortie libre de la **sanybox** MH2000.

Loop

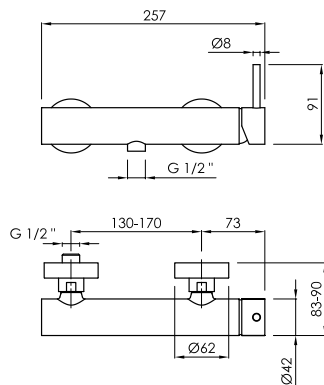

mm



Monomando
Mixer
Mitigeur



Teleducha de latón
Brass handshower
Douchette à main en laiton



Caudal a 3 BAR
Flow rate at 3 BAR
Débit à 3 BAR



Flexo 1,5m PVC
1,5 m PVC hose
Flexible 1,5m PVC

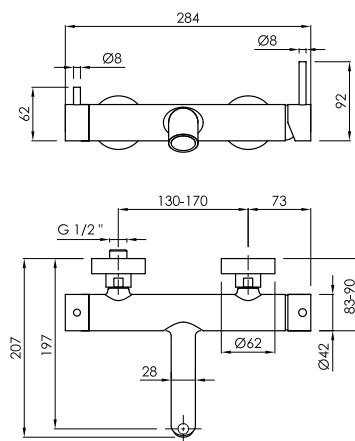

mm



Monomando
Mixer
Mitigeur



Aireador NEOPERL®
NEOPERL® aerator
Aérateur NEOPERL®



Teleducha de latón
Brass handshower
Douchette à main en laiton



Caudal a 3 BAR
Flow rate at 3 BAR
Débit à 3 BAR



Caudal a 3 BAR
Flow rate at 3 BAR
Débit à 3 BAR



Flexo 1,5m PVC
1,5 m PVC hose
Flexible 1,5m PVC

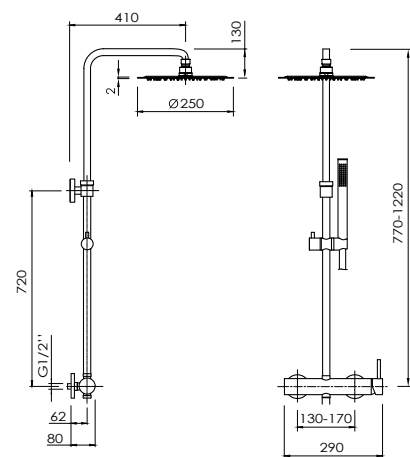

mm



Monomando
Mixer
Mitigeur



Rociador acero inoxidable 2mm
2mm stainless steel showerhead
Douche de tête acier inoxydable
2mm



Altura regulable
Adjustable height
Hauteur réglable



Soporte deslizante y orientable
Sliding and adjustable support
Support coulissant et pivotant



Caudal a 3 BAR
Flow rate at 3 BAR
Débit à 3 BAR



Caudal a 3 BAR
Flow rate at 3 BAR
Débit à 3 BAR



Teleducha de latón
Brass handshower
Douchette à main en laiton



Flexo 1,5m PVC
1,5 m PVC hose
Flexible 1,5m PVC

Monomando exterior para ducha / Exposed shower mixer / Mitigeur de douche exterieur

		CR	BM	MG	NB	BG	RG
<p>sin kit teleducha without hand shower kit sans kit douchette</p> 	MDU001CR	MDU001BM	MDU001MG	MDU001NB	MDU001BG	MDU001RG	
	139 €	160 €	209 €	209 €	209 €	209 €	
<p>con kit teleducha with hand shower kit avec kit douchette</p> 	MDU001CRK	MDU001BMK	MDU001MGK	MDU001NBK	MDU001BGK	MDU001RGK	
	242 €	270 €	385 €	385 €	385 €	385 €	

Monomando exterior para baño ducha / Exposed bath-shower mixer / Mitigeur de bain-douche exterieur

		CR	BM	MG	NB	BG	RG
<p>sin kit teleducha without hand shower kit sans kit douchette</p> 	MDB001CR	MDB001BM	MDB001MG	MDB001NB	MDB001BG	MDB001RG	
	187 €	220 €	297 €	297 €	297 €	297 €	
<p>con kit teleducha with hand shower kit avec kit douchette</p> 	MDB001CRK	MDB001BMK	MDB001MGK	MDB001NBK	MDB001BGK	MDB001RGK	
	297 €	341 €	451 €	451 €	451 €	451 €	

Columna de ducha monomando / Mixer shower column / Colonne de douche mitigeur

		CR	BM	MG	NB	BG	RG
	COMET722	COMO001BM	COMO001MG	COMO001NB	COMO001BG	COMO001RG	
	275 €	380 €	539 €	539 €	539 €	539 €	

Loop

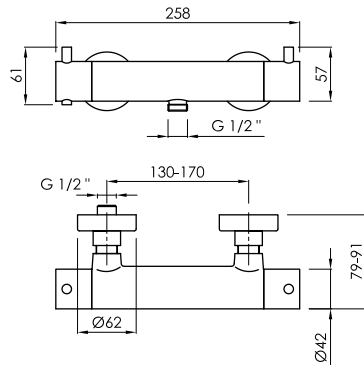

mm



Mezclador termostático
Thermostatic mixer
Melangeur thermostatique



Sistema safe touch
Safe touch body
Sistema safe touch



Cartucho termostático SEDAL®
SEDAL® thermostatic cartridge
Cartouche thermostatique
SEDAL®



Teleducha de latón
Brass handshower
Douchette à main en laiton



Caudal a 3 BAR
Flow rate at 3 BAR
Débit à 3 BAR



Antirretornos NEOPERL®
NEOPERL® check valves
Anti-retours NEOPERL®



Flexo 1,5m PVC
1,5 m PVC hose
Flexible 1,5m PVC

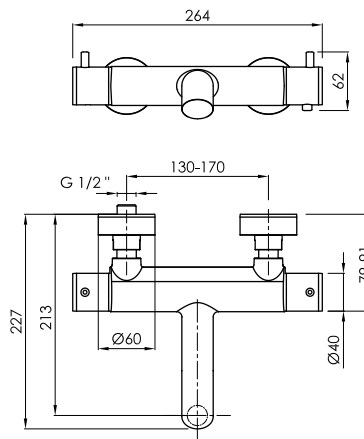

mm



Mezclador termostático
Thermostatic mixer
Melangeur thermostatique



Cartucho termostático VERNET®
VERNET® thermostatic cartridge
Cartouche thermostatique
VERNET®



Teleducha de latón
Brass handshower
Douchette à main en laiton



Caudal a 3 BAR
Flow rate at 3 BAR
Débit à 3 BAR



Caudal a 3 BAR
Flow rate at 3 BAR
Débit à 3 BAR



Antirretornos NEOPERL®
NEOPERL® check valves
Anti-retours NEOPERL®



Flexo 1,5m PVC
1,5 m PVC hose
Flexible 1,5m PVC

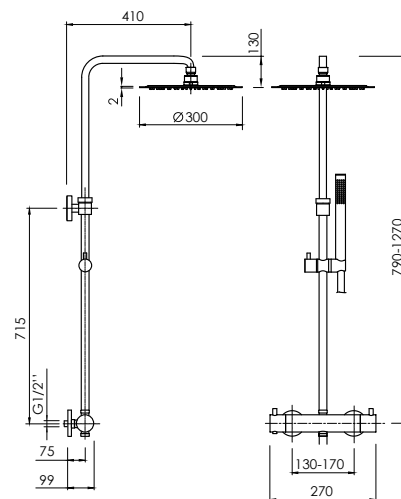

mm



Mezclador termostático
Thermostatic mixer
Melangeur thermostatique



Rociador acero inoxidable 2mm
2mm stainless steel showerhead
Douche de tête acier inoxydable
2mm



Cartucho termostático VERNET®
VERNET® thermostatic cartridge
Cartouche thermostatique
VERNET®



Altura regulable
Adjustable height
Hauteur réglable



Soporte deslizante y orientable
Sliding and adjustable support
Support coulissant et pivotant



Caudal a 3 BAR
Flow rate at 3 BAR
Débit à 3 BAR



Caudal a 3 BAR
Flow rate at 3 BAR
Débit à 3 BAR





Teleducha de latón
Brass handshower
Douchette à main en laiton

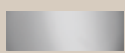
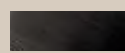

Flexo 1,5m PVC
1,5 m PVC hose
Flexible 1,5m PVC

Termostático exterior para ducha / Exposed shower thermostatic mixer / Thermostatique de douche exterieur

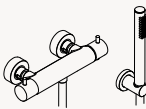
							
		CR	BM	MG	NB	BG	RG
sin kit teleducha without hand shower kit sans kit douchette 	TDU001CR	TDU001BM	TDU001MG	TDU001NB	TDU001BG	TDU001RG	
	220 €	253 €	330 €	330 €	330 €	330 €	
con kit teleducha with hand shower kit avec kit douchette 	TDU001CRK	TDU001BMK	TDU001MGK	TDU001NBK	TDU001BGK	TDU001RGK	
	330 €	374 €	495 €	495 €	495 €	495 €	

Termostático exterior para baño-ducha / Exposed bath-shower thermostatic mixer / Thermostatique de bain-douche exterieur

							
		CR	BM	MG	NB	BG	RG
sin kit teleducha without hand shower kit sans kit douchette 	TDB001CR	TDB001BM	TDB001MG	TDB001NB	TDB001BG	TDB001RG	
	266 €	303 €	407 €	407 €	407 €	407 €	
con kit teleducha with hand shower kit avec kit douchette 	TDB001CRK	TDB001BMK	TDB001MGK	TDB001NBK	TDB001BGK	TDB001RGK	
	380 €	429 €	556 €	556 €	556 €	556 €	

Columna de ducha termostática / Thermostatic shower column / Colonne de douche thermostatique

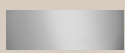
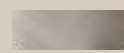
							
		CR	BM	MG	NB	BG	RG
	COMET724	COMET725	COTE001MG	COTE001NB	COTE001BG	COTE001RG	
	384 €	428 €	655 €	655 €	655 €	655 €	

Loop

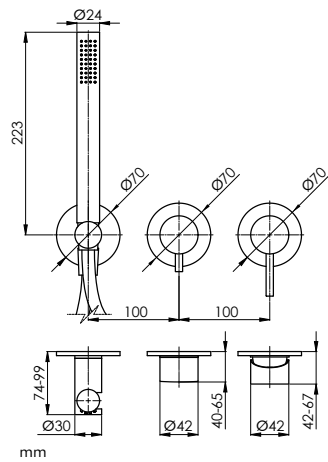

mm



Monomando
Mixer
Mitigeur



Teleducha de latón
Brass handshower
Douchette à main en laiton



Flexo 1,5m PVC
1,5m PVC hose
Flexible 1,5m PVC



2 vías
2 ways
2 voies

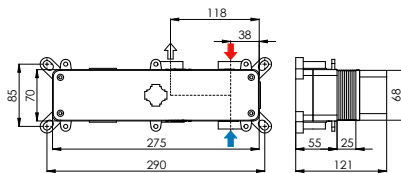

mm



Cuerpo encastre universal
Universal concealed body
Corps d'encastrement universel



Monomando
Mixer
Mitigeur



2 vías
2 ways
2 voies



Caudal a 3 BAR
Flow rate at 3 BAR
Débit à 3 BAR



Caudal a 3 BAR
Flow rate at 3 BAR
Débit à 3 BAR



Conexiones 3/4" hembra latón
Connections 3/4" female brass
Raccordements 3/4" laiton femelle

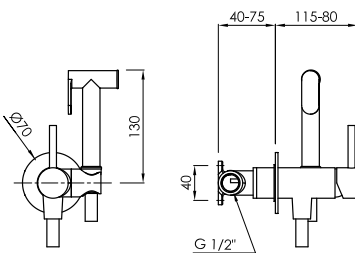

mm



Monomando
Mixer
Mitigeur









Caudal a 3 BAR
Flow rate at 3 BAR
Débit à 3 BAR

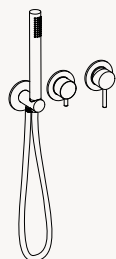

Flexo 1,25m PVC
1,25 m PVC hose
Flexible 1,25m PVC

Monomando de ducha mural horizontal de 2 vías / Wall-mounted shower mixer 2 ways / Mitigeur de douche mural 2 voies

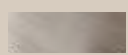

					
CR	BM	MG	NB	BG	RG
MH2D001CR	MH2D001BM	MH2D001MG	MH2D001NB	MH2D001BG	MH2D001RG
260 €*	320 €*	370 €*	370 €*	370 €*	370 €*

sanybox para monomando horizontal 2 vías mural / Horizontal wall-mounted mixer 2 way sanybox / sanybox pour mitigeur horizontal 2 voies mural

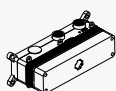

MH2000
230 €

Monomando para bidé-WC mural / Wall-mounted bidet-WC mixer / Mitigeur bidet-WC mural

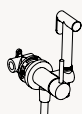

					
CR	BM	MG	NB	BG	RG
WCSH001CR	WCSH001BM	WCSH001MG	WCSH001NB	WCSH001BG	WCSH001RG
154 €	198 €	242 €	242 €	242 €	242 €

* Las griferías murales contemplan solo la parte externa, el pedido debe acompañarse con el cuerpo de empotrar sanybox correspondiente.

* Wall-mounted faucets only include the external part, the order must be accompanied by the corresponding concealed body sanybox.

* Les robinets muraux ne sont que pour la partie extérieure, la commande doit être accompagnée du corps encastré sanybox correspondant.

Loop

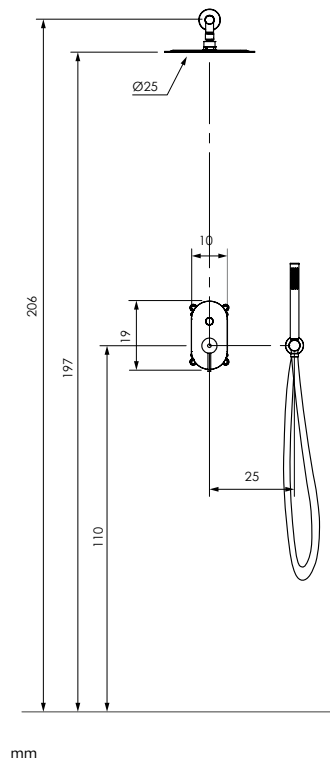

Cuerpo encastre universal
Universal concealed body
Corps d'encastrement universel



Monomando
Mixer
Mitigeur



Cartucho KEROX
KEROX cartridge
Cartouche KEROX



Rociador acero inoxidable 2mm
2mm stainless steel showerhead
Douhe de tête acier inoxydable 2mm



Tetinas antical
Anti-limescale nozzles
Télines anti-calcaire



Latón
Brass
Laiton



Flexo 1,5m PVC
1,5 m PVC hose
Flexible 1,5m PVC



2 vías
2 ways
2 voies



Conexiones 1/2" hembra latón
Connections 1/2" female brass
Raccordements 1/2" laiton femelle



Limitador de caudal
Flow restrictor
Limiteur de débit



Caudal a 3 BAR
Flow rate at 3 BAR
Débit à 3 BAR



Ahorro de agua
Water saving
Économie de l'eau



Teleducha de latón
Brass handshower
Douchette à main en laiton



Sistema anti-torsión
Anti-twist
Système anti-torsion

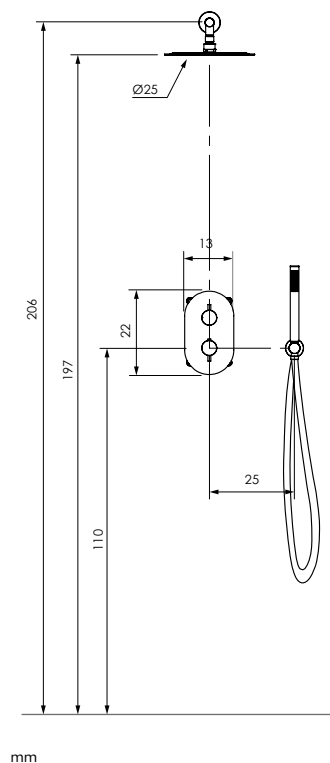

Cuerpo encastre universal
Universal concealed body
Corps d'encastrement universel



Mezclador termostático
Thermostatic mixer
Melangeur thermostatique



Cartucho termostático VERNET®
VERNET® thermostatic cartridge
Cartouche thermostatique VERNET®



Rociador acero inoxidable 2mm
2mm stainless steel showerhead
Douhe de tête acier inoxydable 2mm



Tetinas antical
Anti-limescale nozzles
Télines anti-calcaire



Latón
Brass
Laiton



Flexo 1,5m PVC
1,5 m PVC hose
Flexible 1,5m PVC



2 y 3 vías
2 & 3 ways
2 et 3 voies



Conexiones 1/2" hembra latón
Connections 1/2" female brass
Raccordements 1/2" laiton femelle



Limitador de caudal
Flow restrictor
Limiteur de débit



Caudal a 3 BAR
Flow rate at 3 BAR
Débit à 3 BAR



Ahorro de agua
Water saving
Économie de l'eau



Teleducha de latón
Brass handshower
Douchette à main en laiton



Sistema anti-torsión
Anti-twist
Système anti-torsion

Loop kit monomando mural ducha rociador + teleducha
 Loop kit wall-mounted shower mixer showerhead + handshower
 Loop kit mitigeur de douche mural douche de tête + douchette

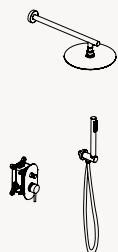
	CR	BM	MG	NB	BG	RG
						
	ME2001CRK	ME2001BMK	ME2001MGK	ME2001NBK	ME2001BGK	ME2001RGK
	484 €	598 €	736€	736 €	736 €	736 €

Loop kit monomando mural

- Monomando de ducha mural 2 vías
- **sanybox** para monomando de ducha mural 2 vías
- Rociador de ducha
- Brazo de ducha mural
- Soporte fijo de teleducha con toma de agua a pared
- Teleducha
- Flexo de ducha

Loop kit wall-mounted shower mixer

- Wall-mounted shower mixer 2 ways
- Wall-mounted shower mixer 2 way **sanybox**
- Shower head
- Wall shower arm
- Hand shower fixed wall support with water outlet
- Hand shower
- Flexible hose

Loop kit mitigeur de douche mural

- Mitigeur de douche mural 2 voies
- **sanybox** pour mitigeur de douche mural 2 voies
- Douche de tête
- Bras de douche mural
- Support mural fixe pour douchette avec sortie
- Douchette
- Flexible de douche

Loop kit termoestático mural ducha rociador + teleducha
 Loop kit wall-mounted thermostatic shower mixer showerhead + handshower
 Loop kit thermostatique de douche mural douche de tête + douchette

	CR	BM	MG	NB	BG	RG
						
	TE3001CRK	TE3001BMK	TE3001MGK	TE3001NBK	TE3001BGK	TE3001RGK
	624 €	796 €	918€	918 €	918 €	918 €

Loop kit termoestático mural

- Termoestático de ducha mural 1-2-3 vías
- **sanybox** termoestático de ducha mural 2-3 vías
- Rociador de ducha
- Brazo de ducha mural
- Soporte fijo de teleducha con toma de agua a pared
- Teleducha
- Flexo de ducha

Loop kit wall-mounted thermostatic shower mixer

- Wall-mounted shower thermostatic 1-2-3 ways
- Wall-mounted shower thermostatic mixer 2-3 ways **sanybox**
- Shower head
- Wall shower arm
- Hand shower fixed wall support with water outlet
- Hand shower
- Flexible hose

Loop kit thermostatique de douche mural

- Thermostatique de douche mural 1-2-3 voies
- **sanybox** thermostatique de douche mural 2-3 voies
- Douche de tête
- Bras de douche mural
- Support mural fixe pour douchette avec sortie
- Douchette
- Flexible de douche

Loop

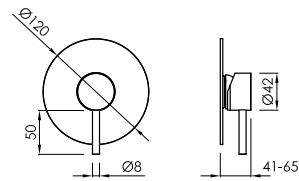

mm



Monomando
Mixer
Mitigeur



1 vía
1 way
1 voie

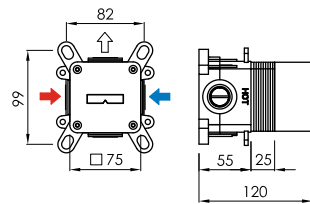

mm



Cuerpo encastre universal
Universal concealed body
Corps d'encastrement universel



Monomando
Mixer
Mitigeur



Cartucho KEROX
KEROX cartridge
Cartouche KEROX



Caudal a 3 BAR
Flow rate at 3 BAR
Débit à 3 BAR



1 vía
1 way
1 voie



Conexiones 1/2" hembra latón
Connections 1/2" female brass
Raccordements 1/2" laiton femelle

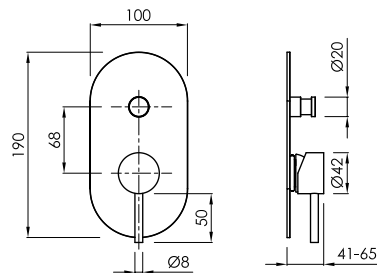

mm



Monomando
Mixer
Mitigeur



2 vías
2 ways
2 voies

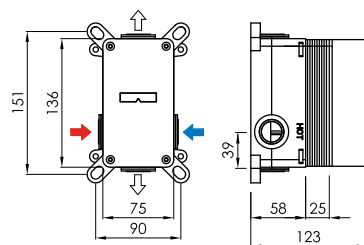

mm



Cuerpo encastre universal
Universal concealed body
Corps d'encastrement universel



Monomando
Mixer
Mitigeur



Cartucho KEROX
KEROX cartridge
Cartouche KEROX



Caudal a 3 BAR
Flow rate at 3 BAR
Débit à 3 BAR





2 vías
2 ways
2 voies



Conexiones 1/2" hembra latón
Connections 1/2" female brass
Raccordements 1/2" laiton femelle

Monomando de ducha mural 1 vía / Wall-mounted shower mixer 1 way / Mitigeur de douche mural 1 voie

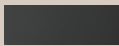
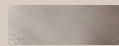

					
CR	BM	MG	NB	BG	RG
ME1001CR	ME1001BM	ME1001MG	ME1001NB	ME1001BG	ME1001RG
75 €*	116 €*	160 €*	160 €*	160 €*	160 €*

sanybox para monomando de ducha mural 1 vía / Wall-mounted shower mixer 1 way sanybox / sanybox pour mitigeur de douche mural 1 voie



ME1000

95 €

Monomando de ducha mural 2 vías / Wall-mounted shower mixer 2 ways / Mitigeur de douche mural 2 voies

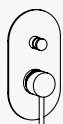

					
CR	BM	MG	NB	BG	RG
ME2001CR	ME2001BM	ME2001MG	ME2001NB	ME2001BG	ME2001RG
86 €*	138 €*	187 €*	187 €*	187 €*	187 €*

sanybox para monomando de ducha mural 2 vías / Wall-mounted shower mixer 2 way sanybox / sanybox pour mitigeur de douche mural 2 voies mural

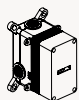

ME2000

115 €

* Las griferías murales contemplan solo la parte externa, el pedido debe acompañarse con el cuerpo de empotrar **sanybox** correspondiente.

* Wall-mounted faucets only include the external part, the order must be accompanied by the corresponding concealed body **sanybox**.

* Les robinets muraux ne sont que pour la partie extérieure, la commande doit être accompagnée du corps encastré **sanybox** correspondant.

Loop

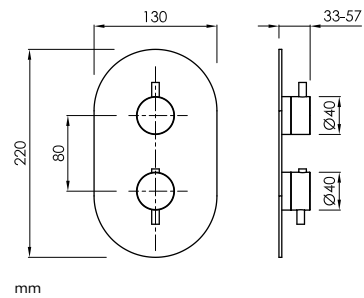

mm



Mezclador termostático
Thermostatic mixer
Melangeur thermostatique



1 vía
1 way
1 voie



2 y 3 vías
2 & 3 ways
2 et 3 voies

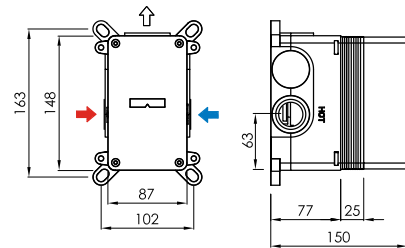

mm



Cuerpo encastre universal
Universal concealed body
Corps d'encastrement universel



Mezclador termostático
Thermostatic mixer
Melangeur thermostatique



Cartucho termostático VERNET®
VERNET® thermostatic cartridge
Cartouche thermostatique VERNET®



Caudal a 3 BAR
Flow rate at 3 BAR
Débit à 3 BAR



1 vía
1 way
1 voie



Conexiones 3/4" hembra latón
Connections 3/4" female brass
Raccordements 3/4" laiton femelle

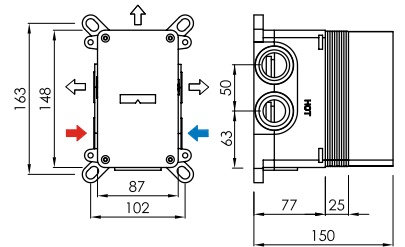

mm



Cuerpo encastre universal
Universal concealed body
Corps d'encastrement universel



Mezclador termostático
Thermostatic mixer
Melangeur thermostatique



Cartucho termostático VERNET®
VERNET® thermostatic cartridge
Cartouche thermostatique VERNET®



Caudal a 3 BAR
Flow rate at 3 BAR
Débit à 3 BAR



2 y 3 vías
2 & 3 ways
2 et 3 voies



Conexiones 3/4" hembra latón
Connections 3/4" female brass
Raccordements 3/4" laiton femelle

Termostático de ducha mural 1-2-3 vías / Wall-mounted shower thermostatic mixer 1-2-3 ways / Thermostatique de douche mural 1-2-3 voies

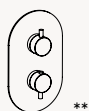

**

					
CR	BM	MG	NB	BG	RG
T13001CR	T13001BM	T13001MG	T13001NB	T13001BG	T13001RG
132 €*	242 €*	275 €*	275 €*	275 €*	275 €*

sanybox termostático de ducha mural 1 vía / Wall-mounted shower thermostatic mixer 1 way sanybox / sanybox thermostatique de douche mural 1voie



TE1000

193 €

sanybox termostático de ducha mural 2-3 vías / Wall-mounted shower thermostatic mixer 2-3 ways sanybox / sanybox thermostatique de douche mural 2-3 voies



TE3000

209 €

* Las griferías murales contemplan solo la parte externa, el pedido debe acompañarse con el cuerpo de empotrar **sanybox** correspondiente.

** Artículo compatible con **sanybox** termostático de 1 vía y con **sanybox** termostático de 2-3 vías.

* Wall-mounted faucets only include the external part, the order must be accompanied by the corresponding concealed body **sanybox**.

** Article compatible with 1-way thermostatic **sanybox** and 2-3-way thermostatic **sanybox**.

* Les robinets muraux ne sont que pour la partie extérieure, la commande doit être accompagnée du corps encastré **sanybox** correspondant.

** Article compatible avec le **sanybox** thermostatique à 1 voie et le **sanybox** thermostatique à 2 ou 3 voies.

Loop

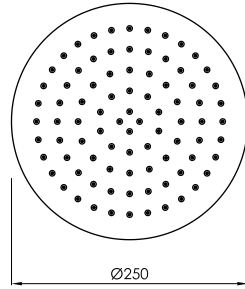
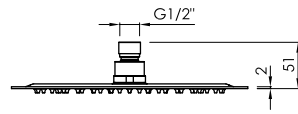

mm



Rociador acero inoxidable 2mm
2mm stainless steel showerhead
Douhe de tête acier inoxydable
2mm



Tetinas antical
Anti-limescale nozzles
Télines anti-calcaire



Limitador de caudal
Flow restrictor
Limiteur de débit



Ahorro de agua
Water saving
Économie de l'eau

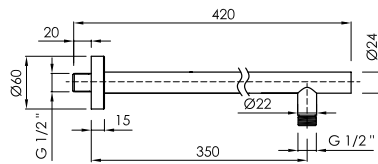

mm



Latón
Brass
Laiton

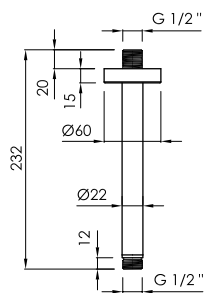

mm



Latón
Brass
Laiton

Rociador de ducha / Shower head / Douche de tête



					
CR	BM	MG	NB	BG	RG
ROC001CR	ROC001BM	ROC001MG	ROC001NB	ROC001BG	ROC001RG
95 €	127 €	160 €	160 €	160 €	160 €



Brazo de ducha mural / Wall shower arm / Bras de douche mural



					
CR	BM	MG	NB	BG	RG
BRP00140CR	BRP00140BM	BRP00140MG	BRP00140NB	BRP00140BG	BRP00140RG
70 €	80 €	99 €	99 €	99 €	99 €

Brazo de ducha a techo / Ceiling shower arm / Bras de douche au plafond

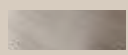

					
CR	BM	MG	NB	BG	RG
BRT00120CR	BRT00120BM	BRT00120MG	BRT00120NB	BRT00120BG	BRT00120RG
55 €	65 €	75 €	75 €	75 €	75 €

Loop

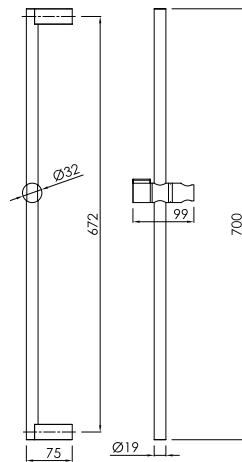

mm



Soporte deslizante y orientable
Sliding and adjustable support
Support coulissant et pivotant



Barra deslizante metálica
Metal sliding shower bar
Barre de douche métallique



Teleducha no incluida
Hand shower not included
Douchette non incluse

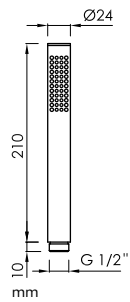

mm



Teleducha de latón
Brass handshower
Douchette à main en laiton



Tetinas antica
Anti-limescale nozzles
Tétines anti-calcaire



Flexo 1,5m PVC
1,5 m PVC hose
Flexible 1,5m PVC



Sistema anti-torsión
Anti-twist
Système anti-torsion

Barra de ducha deslizante / Sliding shower bar / Barre de douche coulissante

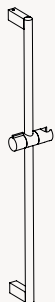

						
	CR	BM	MG	NB	BG	RG
	BAR00170CR	BAR00170BM	BAR00170MG	BAR00170NB	BAR00170BG	BAR00170RG
	76 €	143 €	160 €	160 €	160 €	160 €

Teleducha / Hand shower / Douchette



						
	CR	BM	MG	NB	BG	RG
	TEL001CR	TEL001BM	TEL001MG	TEL001NB	TEL001BG	TEL001RG
	42 €	48 €	61 €	61 €	61 €	61 €

Flexo de ducha / Flexible hose / Flexible de douche

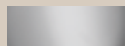
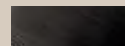

						
	CR	BM	MG	NB	BG	RG
	FLE010CR	FLE010BM	FLE010MG	FLE010NB	FLE010BG	FLE010RG
	32 €	35 €	42 €	42 €	42 €	42 €

Loop

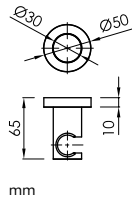

mm



Latón
Brass
Laiton

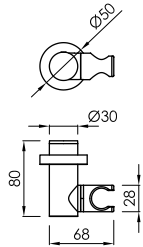

mm



Latón
Brass
Laiton

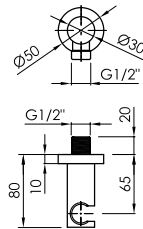

mm



Latón
Brass
Laiton

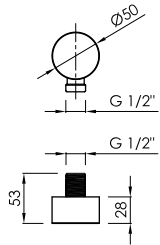

mm



Latón
Brass
Laiton

Soporte de teleducha a pared fijo / Hand shower fixed wall support / Support mural fixe pour douchette



CR	BM	MG	NB	BG	RG
SOP001CR	SOP001BM	SOP001MG	SOP001NB	SOP001BG	SOP001RG
39 €	50 €	61 €	61 €	61 €	61 €

Soporte de teleducha a pared orientable / Hand shower swivel wall support / Support mural pivotant pour douchette



CR	BM	MG	NB	BG	RG
SOO001CR	SOO001BM	SOO001MG	SOO001NB	SOO001BG	SOO001RG
50 €	61 €	88 €	88 €	88 €	88 €

Soporte de teleducha con toma de agua / Hand shower support with water outlet / Support mural pour douchette avec sortie



CR	BM	MG	NB	BG	RG
STM001CR	STM001BM	STM001MG	STM001NB	STM001BG	STM001RG
44 €	55 €	72 €	72 €	72 €	72 €

Toma de agua mural / Wall shower outlet / Coude de sortie mural



CR	BM	MG	NB	BG	RG
TOM001CR	TOM001BM	TOM001MG	TOM001NB	TOM001BG	TOM001RG
33 €	44 €	61 €	61 €	61 €	61 €

Loop K



Monomando de lavabo
Basin mixer
Mitigeur de lavabo
p. 99



Monomando alto de lavabo
High basin mixer
Mitigeur haut de lavabo
p. 99



Monomando de bidé
Bidet mixer
Mitigeur de bidet
p. 101



Monomando exento de lavabo
Freestanding basin mixer
Mitigeur de pied de lavabo
p. 107



Monomando de lavabo mural
Wall-mounted basin mixer
Mitigeur de lavabo mural
p. 103



sanybox para monomando lavabo mural
Wall-mounted basin mixer **sanybox**
sanybox pour mitigeur de lavabo mural
p. 105



Grifería de pie para bañera
Freestanding faucet for bathtub
Robinetterie de pied pour baignoire
p. 107



Monomando borde bañera
Deck mounted mixer for bathtub
Mitigeur au bord pour baignoire
p. 109



Caño de bañera mural
Wall-mounted bathtub spout
Canon mural pour baignoire
p. 111



Monomando de ducha mural horizontal de 2 vías
Wall-mounted shower mixer 2 ways
Mitigeur de douche mural 2 voies
p. 111



sanybox para monomando horizontal 2 vías mural
Horizontal wall-mounted mixer 2 ways **sanybox**
sanybox pour mitigeur horizontal 2 voies mural
p. 111



Monomando exterior para ducha
Exposed shower mixer
Mitigeur de douche exterieur
p. 113



Monomando exterior para baño-
ducha
Exposed bath-shower mixer
Mitigeur de bain-douche exterieur
p. 115



Columna de ducha monomando
Mixer shower column
Colonne de douche mitigeur
p. 117



Termostático exterior para ducha
Exposed shower thermostatic mixer
Thermostatique de douche exterieur
p.119



Termostático exterior para baño-
ducha
Exposed bath-shower thermostatic
mixer
Thermostatique de bain-douche
exterieur
p. 121



Columna de ducha termostática
Thermostatic shower column
Colonne de douche
thermostatique
p. 111



Monomando de ducha mural
horizontal de 2 vías
Wall-mounted shower mixer 2 ways
Mitigeur de douche mural 2 voies
p. 111



sanybox para monomando
horizontal 2 vías mural
Horizontal wall-mounted mixer 2
ways **sanybox**
sanybox pour mitigeur horizontal 2
voies mural
p. 111

Loop K



Monomando ducha mural 1 vía
Wall-mounted shower mixer 1 way
Mitigeur de douche mural 1 voie
p. 127



sanybox para monomando de ducha mural 1 vía
Wall-mounted shower mixer 1 way **sanybox**
sanybox pour mitigeur de douche mural 1 voie
p. 127



Monomando de ducha mural 2 vías
Wall-mounted shower mixer 2 ways
Mitigeur de douche mural 2 voies
p. 129



sanybox para monomando de ducha mural 2 vías
Wall-mounted shower mixer 2 way **sanybox**
sanybox pour mitigeur de douche mural 2 voies mural
p. 129



Termostático de ducha mural 1-2-3 vías

Wall-mounted shower thermostatic mixer 1-2-3 ways

Thermostatique de douche mural 1-2-3 voies

p. 131



sanybox para termostático de ducha mural 1 vía

Wall-mounted shower thermostatic mixer 1 way **sanybox**

sanybox pour thermostatique de douche mural 1voie

p. 131



sanybox para termostático de ducha mural 2-3 vías

Wall-mounted shower thermostatic mixer 2-3 ways **sanybox**

sanybox pour thermostatique de douche mural 2-3 voies

p. 131

Loop K

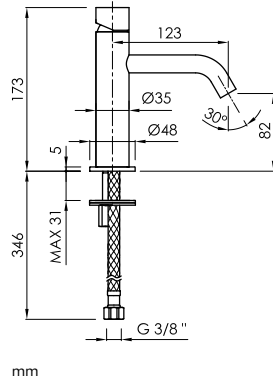

Apertura en frío
Cold open
Ouverture en eau froide



Ahorro de energía
Energy saving
Économie d'énergie



Aireador NEOPERL®
NEOPERL® aerator
Aérateur NEOPERL®



Para válvula click clack
For pop-up waste
Pour bonde click-clack



Caudal a 3 BAR
Flow rate at 3 BAR
Débit à 3 BAR



Cartucho SEDAL®
SEDAL® cartridge
Cartouche SEDAL®



Latiguillos TUCAI®
TUCAI® hoses
Flexible TUCAI®



Válvula no incluida
Waste not included
Bonde non incluse

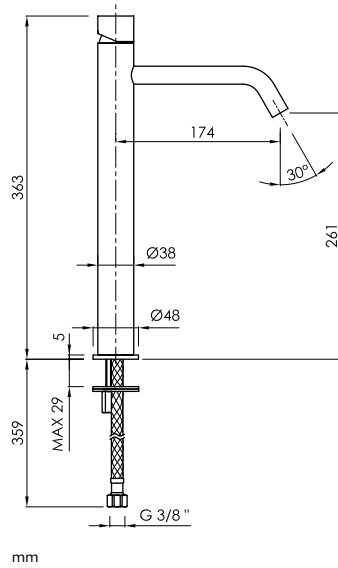

Apertura en frío
Cold open
Ouverture en eau froide



Ahorro de energía
Energy saving
Économie d'énergie



Aireador NEOPERL®
NEOPERL® aerator
Aérateur NEOPERL®



Para válvula click clack
For pop-up waste
Pour bonde click-clack



Caudal a 3 BAR
Flow rate at 3 BAR
Débit à 3 BAR



Cartucho SEDAL®
SEDAL® cartridge
Cartouche SEDAL®



Latiguillos TUCAI®
TUCAI® hoses
Flexible TUCAI®



Válvula no incluida
Waste not included
Bonde non incluse

Monomando de lavabo / Basin mixer / Mitigeur de lavabo

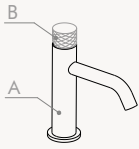

A \ B	CR	BM	MG	NB	BG	RG
CR	MNO011CRCR 187 €	MNO011CRBM 209 €	MNO011CRMG 253 €	MNO011CRNB 253 €	MNO011CRBG 253 €	MNO011CRRG 253 €
BM	MNO011BMCR 209 €	MNO011BMBM 215 €	MNO011BMMG 270 €	MNO011BMNB 270 €	MNO011BMBG 270 €	MNO011BMRG 270 €
MG	MNO011MGCR 270 €	MNO011MGBM 270 €	MNO011MGMG 270 €	MNO011MGNB 270 €	MNO011MGBG 270 €	MNO011MGRG 270 €
NB	MNO011NBCR 270 €	MNO011NBBM 270 €	MNO011NBMG 270 €	MNO011NB NB 270 €	MNO011NBBG 270 €	MNO011NBRG 270 €
BG	MNO011BGCR 270 €	MNO011BGBM 270 €	MNO011BGMG 270 €	MNO011BGNB 270 €	MNO011BGBG 270 €	MNO011BGRG 270 €
RG	MNO011RGCR 270 €	MNO011RGBM 270 €	MNO011RGMG 270 €	MNO011RGNB 270 €	MNO011RGBG 270 €	MNO011RGRG 270 €

Monomando alto de lavabo / High basin mixer / Mitigeur haut de lavabo

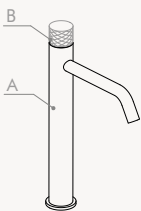

A \ B	CR	BM	MG	NB	BG	RG
CR	MOA011CRCR 275 €	MOA011CRBM 308 €	MOA011CRMG 352 €	MOA011CRNB 352 €	MOA011CRBG 352 €	MOA011CRRG 352 €
BM	MOA011BMCR 308 €	MOA011BMBM 319 €	MOA011BMMG 385 €	MOA011BMNB 385 €	MOA011BMBG 385 €	MOA011BMRG 385 €
MG	MOA011MGCR 385 €	MOA011MGBM 385 €	MOA011MGMG 385 €	MOA011MGNB 385 €	MOA011MGBG 385 €	MOA011MGRG 385 €
NB	MOA011NBCR 385 €	MOA011NB BM 385 €	MOA011NBMG 385 €	MOA011NB NB 385 €	MOA011NBBG 385 €	MOA011NBRG 385 €
BG	MOA011BGCR 385 €	MOA011BG BM 385 €	MOA011BGMG 385 €	MOA011BGNB 385 €	MOA011BGBG 385 €	MOA011BGRG 385 €
RG	MOA011RGCR 385 €	MOA011RGBM 385 €	MOA011RGMG 385 €	MOA011RGNB 385 €	MOA011RGBG 385 €	MOA011RGRG 385 €

Loop K

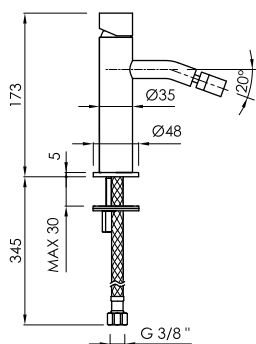

mm



Apertura en frío
Cold open
Ouverture en eau froide



Ahorro de energía
Energy saving
Économie d'énergie



Aireador orientable NEOPERL®
NEOPERL® adjustable aerator
Aérateur réglable NEOPERL®



Para válvula click clack
For pop-up waste
Pour bonde click-clack



Caudal a 3 BAR
Flow rate at 3 BAR
Débit à 3 BAR



Cartucho SEDAL®
SEDAL® cartridge
Cartouche SEDAL®



Latiguillos TUCAI®
TUCAI® hoses
Flexible TUCAI®



Válvula no incluida
Waste not included
Bonde non incluse

Monomando de bidé / Bidet mixer / Mitigeur de bidet

A \ B	CR	BM	MG	NB	BG	RG
CR	MBD011CRCR 187 €	MBD011CRBM 209 €	MBD011CRMG 253 €	MBD011CRNB 253 €	MBD011CRBG 253 €	MBD011CRRG 253 €
BM	MBD011BMCR 209 €	MBD011BMBM 215 €	MBD011BMMG 270 €	MBD011BMNB 270 €	MBD011BMBG 270 €	MBD011BMRG 270 €
MG	MBD011MGCR 270 €	MBD011MGBM 270 €	MBD011MGMG 270 €	MBD011MGNB 270 €	MBD011MGBG 270 €	MBD011MGRG 270 €
NB	MBD011NBCR 270 €	MBD011NBBM 270 €	MBD011NBMG 270 €	MBD011NBNB 270 €	MBD011NBBG 270 €	MBD011NBRG 270 €
BG	MBD011BGCR 270 €	MBD011BGBM 270 €	MBD011BGMG 270 €	MBD011BGNB 270 €	MBD011BGBG 270 €	MBD011BGRG 270 €
RG	MBD011RGCR 270 €	MBD011RGBM 270 €	MBD011RGMG 270 €	MBD011RGNB 270 €	MBD011RGBG 270 €	MBD011RGRG 270 €

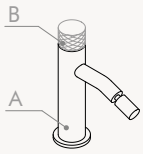

Loop K

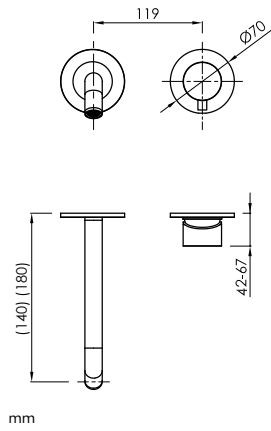

Apertura en frío
Cold open
Ouverture en eau froide



Ahorro de energía
Energy saving
Économie d'énergie



Aireador NEOPERL®
NEOPERL® aerator
Aérateur NEOPERL®



Caudal a 3 BAR
Flow rate at 3 BAR
Débit à 3 BAR



Cartucho KEROX
KEROX cartridge
Cartouche KEROX

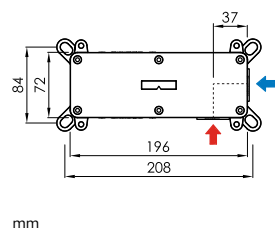

Cuerpo encastre universal
Universal concealed body
Corps d'encastrement universel



Ahorro de energía
Energy saving
Économie d'énergie



Apertura en frío
Cold open
Ouverture en eau froide



Conexiones 1/2" hembra latón
Connections 1/2" female brass
Raccordements 1/2" laiton femelle

Monomando de lavabo mural / Wall-mounted basin mixer / Mitigeur de lavabo mural

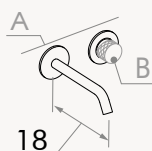

A \ B	CR	BM	MG	NB	BG	RG
CR	MEN011R18CRCR 127 €*	MEN011R18CRBM 165 €*	MEN011R18CRMG 187 €*	MEN011R18CRNB 187 €*	MEN011R18CRBG 187 €*	MEN011R18CRRG 187 €*
BM	MEN011R18BMCRCR 165 €*	MEN011R18BMBM 171 €*	MEN011R18BMMG 215 €*	MEN011R18BMNB 215 €*	MEN011R18BMBG 215 €*	MEN011R18BMRG 215 €*
MG	MEN011R18MGCR 215 €*	MEN011R18MGBM 215 €*	MEN011R18MGMG 215 €*	MEN011R18MGNB 215 €*	MEN011R18MGBG 215 €*	MEN011R18MGRG 215 €*
NB	MEN011R18NBCR 215 €*	MEN011R18NBBM 215 €*	MEN011R18NBMG 215 €*	MEN011R18NBNB 215 €*	MEN011R18NBBG 215 €*	MEN011R18NBRG 215 €*
BG	MEN011R18BGCR 215 €*	MEN011R18BGBM 215 €*	MEN011R18BGMG 215 €*	MEN011R18BGNB 215 €*	MEN011R18BGBG 215 €*	MEN011R18BGRG 215 €*
RG	MEN011R18RGCR 215 €*	MEN011R18RGBM 215 €*	MEN011R18RGMG 215 €*	MEN011R18RGNB 215 €*	MEN011R18RGBG 215 €*	MEN011R18RGRG 215 €*



A \ B	CR	BM	MG	NB	BG	RG
CR	MEN011R14CRCR 165 €*	MEN011R14CRBM 204 €*	MEN011R14CRMG 226 €*	MEN011R14CRNB 226 €*	MEN011R14CRBG 226 €*	MEN011R14CRRG 226 €*
BM	MEN011R14BMCRCR 204 €*	MEN011R14BMBM 209 €*	MEN011R14BMMG 253 €*	MEN011R14BMNB 253 €*	MEN011R14BMBG 253 €*	MEN011R14BMRG 253 €*
MG	MEN011R14MGCR 253 €*	MEN011R14MGBM 253 €*	MEN011R14MGMG 253 €*	MEN011R14MGNB 253 €*	MEN011R14MGBG 253 €*	MEN011R14MGRG 253 €*
NB	MEN011R14NBCR 253 €*	MEN011R14NBBM 253 €*	MEN011R14NBMG 253 €*	MEN011R14NBNB 253 €*	MEN011R14NBBG 253 €*	MEN011R14NBRG 253 €*
BG	MEN011R14BGCR 253 €*	MEN011R14BGBM 253 €*	MEN011R14BGMG 253 €*	MEN011R14BGNB 253 €*	MEN011R14BGBG 253 €*	MEN011R14BGRG 253 €*
RG	MEN011R14RGCR 253 €*	MEN011R14RGBM 253 €*	MEN011R14RGMG 253 €*	MEN011R14RGNB 253 €*	MEN011R14RGBG 253 €*	MEN011R14RGRG 253 €*

sanybox para monomando lavabo mural / Wall-mounted basin mixer sanybox / sanybox pour mitigeur de lavabo mural

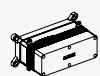

MEN000

140 €

* Las griferías murales contemplan solo la parte externa, el pedido debe acompañarse con el cuerpo de empotrar sanybox correspondiente.

* Wall-mounted faucets only include the external part, the order must be accompanied by the corresponding concealed body sanybox.

* Les robinets muraux ne sont que pour la partie extérieure, la commande doit être accompagnée du corps encastré sanybox correspondant.

Loop K

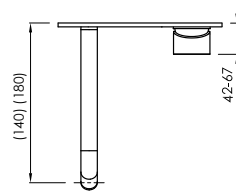
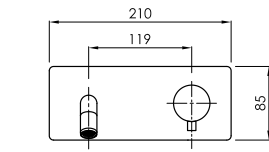

mm



Apertura en frío
Cold open
Ouverture en eau froide



Ahorro de energía
Energy saving
Économie d'énergie



Aireador NEOPERL®
NEOPERL® aerator
Aérateur NEOPERL®



Caudal a 3 BAR
Flow rate at 3 BAR
Débit à 3 BAR



Cartucho KEROX
KEROX cartridge
Cartouche KEROX

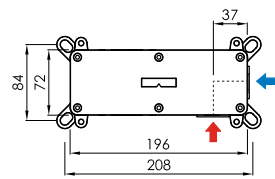

mm

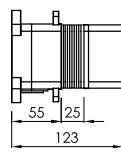

Cuerpo encastre universal
Universal concealed body
Corps d'encastrement universel



Ahorro de energía
Energy saving
Économie d'énergie



Apertura en frío
Cold open
Ouverture en eau froide



Conexiones 1/2" hembra latón
Connections 1/2" female brass
Raccordements 1/2" laiton femelle

Monomando de lavabo mural / Wall-mounted basin mixer / Mitigeur de lavabo mural

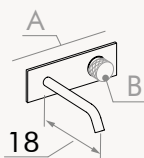

A \ B	CR	BM	MG	NB	BG	RG
CR	MEN011S18CRCR 182 €*	MEN011S18CRBM 253 €*	MEN011S18CRMG 275 €*	MEN011S18CRNB 275 €*	MEN011S18CRBG 275 €*	MEN011S18CRRG 275 €*
BM	MEN011S18BMCR 253 €*	MEN011S18BMBM 259 €*	MEN011S18BMMG 303 €*	MEN011S18BMNB 303 €*	MEN011S18BMBG 303 €*	MEN011S18BMRG 303 €*
MG	MEN011S18MGCR 303 €*	MEN011S18MGBM 303 €*	MEN011S18MGMG 303 €*	MEN011S18MGNB 303 €*	MEN011S18MGBG 303 €*	MEN011S18MGRG 303 €*
NB	MEN011S18NBCR 303 €*	MEN011S18NBBM 303 €*	MEN011S18NBMG 303 €*	MEN011S18NBNB 303 €*	MEN011S18NBBG 303 €*	MEN011S18NBRG 303 €*
BG	MEN011S18BGCR 303 €*	MEN011S18BGBM 303 €*	MEN011S18BGMG 303 €*	MEN011S18BGNB 303 €*	MEN011S18BGBG 303 €*	MEN011S18BGRG 303 €*
RG	MEN011S18RGCR 303 €*	MEN011S18RGBM 303 €*	MEN011S18RGMG 303 €*	MEN011S18RGNB 303 €*	MEN011S18RGBG 303 €*	MEN011S18RGRG 303 €*

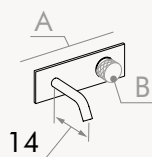

A \ B	CR	BM	MG	NB	BG	RG
CR	MEN011S14CRCR 220 €*	MEN011S14CRBM 292 €*	MEN011S14CRMG 314 €*	MEN011S14CRNB 314 €*	MEN011S14CRBG 314 €*	MEN011S14CRRG 314 €*
BM	MEN011S14BMCR 292 €*	MEN011S14BMBM 297 €*	MEN011S14BMMG 341 €*	MEN011S14BMNB 341 €*	MEN011S14BMBG 341 €*	MEN011S14BMRG 341 €*
MG	MEN011S14MGCR 341 €*	MEN011S14MGBM 341 €*	MEN011S14MGMG 341 €*	MEN011S14MGNB 341 €*	MEN011S14MGBG 341 €*	MEN011S14MGRG 341 €*
NB	MEN011S14NBCR 341 €*	MEN011S14NBBM 341 €*	MEN011S14NBMG 341 €*	MEN011S14NBNB 341 €*	MEN011S14NBBG 341 €*	MEN011S14NBRG 341 €*
BG	MEN011S14BGCR 341 €*	MEN011S14BGBM 341 €*	MEN011S14BGMG 341 €*	MEN011S14BGNB 341 €*	MEN011S14BGBG 341 €*	MEN011S14BGRG 341 €*
RG	MEN011S14RGCR 341 €*	MEN011S14RGBM 341 €*	MEN011S14RGMG 341 €*	MEN011S14RGNB 341 €*	MEN011S14RGBG 341 €*	MEN011S14RGRG 341 €*

sanybox para monomando de lavabo mural / Wall-mounted basin mixer sanybox / sanybox pour mitigeur de lavabo mural

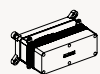

MEN000

140 €

* Las griferías murales contemplan solo la parte externa, el pedido debe acompañarse con el cuerpo de empotrar sanybox correspondiente.

* Wall-mounted faucets only include the external part, the order must be accompanied by the corresponding concealed body sanybox.

* Les robinets muraux ne sont que pour la partie extérieure, la commande doit être accompagnée du corps encastré sanybox correspondant.

Loop K

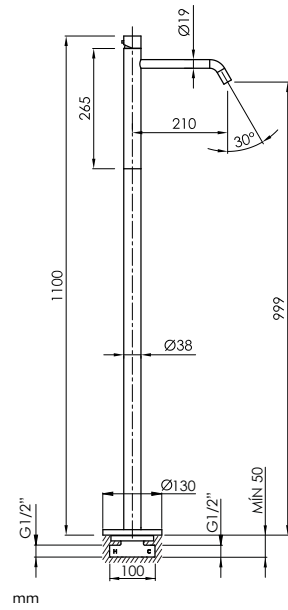

Apertura en frío
Cold open
Ouverture en eau froide



Ahorro de energía
Energy saving
Économie d'énergie



Aireador NEOPERL®
NEOPERL® aerator
Aérateur NEOPERL®



Caudal a 3 BAR
Flow rate at 3 BAR
Débit à 3 BAR



Cartucho SEDAL®
SEDAL® cartridge
Cartouche SEDAL®

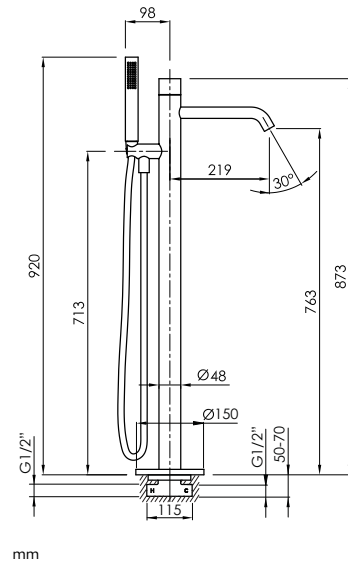

Caudal a 3 BAR
Flow rate at 3 BAR
Débit à 3 BAR



Teleducha de latón
Brass handshower
Douchette à main en laiton



Aireador NEOPERL®
NEOPERL® aerator
Aérateur NEOPERL®



Caudal a 3 BAR
Flow rate at 3 BAR
Débit à 3 BAR



Flexo 1,5m PVC
1,5 m PVC hose
Flexible 1,5m PVC

Monomando exento de lavabo / Freestanding basin mixer / Mitigeur de pied de lavabo



A \ B	CR	BM	MG	NB	BG	RG
CR	MEX011CRCR 638 €	MEX011CRBM 743 €	MEX011CRMG 765 €	MEX011CRNB 765 €	MEX011CRBG 765 €	MEX011CRRG 765 €
BM	MEX011BMCR 743 €	MEX011BMBM 748 €	MEX011BMMG 787 €	MEX011BMNB 787 €	MEX011BMBG 787 €	MEX011BMRG 787 €
MG	MEX011MGCR 787 €	MEX011MGBM 787 €	MEX011MGMG 787 €	MEX011MGNB 787 €	MEX011MGBG 787 €	MEX011MGRG 787 €
NB	MEX011NBCR 787 €	MEX011NBBM 787 €	MEX011NBMG 787 €	MEX011NBNB 787 €	MEX011NBBG 787 €	MEX011NBRG 787 €
BG	MEX011BGCR 787 €	MEX011BGBM 787 €	MEX011BGMG 787 €	MEX011BGNB 787 €	MEX011BGBG 787 €	MEX011BGRG 787 €
RG	MEX011RGCR 787 €	MEX011RGBM 787 €	MEX011RGMG 787 €	MEX011RGNB 787 €	MEX011RGBG 787 €	MEX011RGRG 787 €

Grifería de pie para bañera / Freestanding faucet for bathtub / Robinetterie de pied pour baignoire



A \ B	CR	BM	MG	NB	BG	RG
CR	BNEX011CRCR 1.111 €	BNEX011CRBM 1.276 €	BNEX011CRMG 1.430 €	BNEX011CRNB 1.430 €	BNEX011CRBG 1.430 €	BNEX011CRRG 1.430 €
BM	BNEX011BMCR 1.276 €	BNEX011BMBM 1.282 €	BNEX011BMMG 1.650 €	BNEX011BMNB 1.650 €	BNEX011BMBG 1.650 €	BNEX011BMRG 1.650 €
MG	BNEX011MGCR 1.650 €	BNEX011MGBM 1.650 €	BNEX011MGMG 1.650 €	BNEX011MGNB 1.650 €	BNEX011MGBG 1.650 €	BNEX011MGRG 1.650 €
NB	BNEX011NBCR 1.650 €	BNEX011NBBM 1.650 €	BNEX011NBMG 1.650 €	BNEX011NBNB 1.650 €	BNEX011NBBG 1.650 €	BNEX011NBRG 1.650 €
BG	BNEX011BGCR 1.650 €	BNEX011BGBM 1.650 €	BNEX011BGMG 1.650 €	BNEX011BGNB 1.650 €	BNEX011BGBG 1.650 €	BNEX011BGRG 1.650 €
RG	BNEX011RGCR 1.650 €	BNEX011RGBM 1.650 €	BNEX011RGMG 1.650 €	BNEX011RGNB 1.650 €	BNEX011RGBG 1.650 €	BNEX011RGRG 1.650 €

Loop K

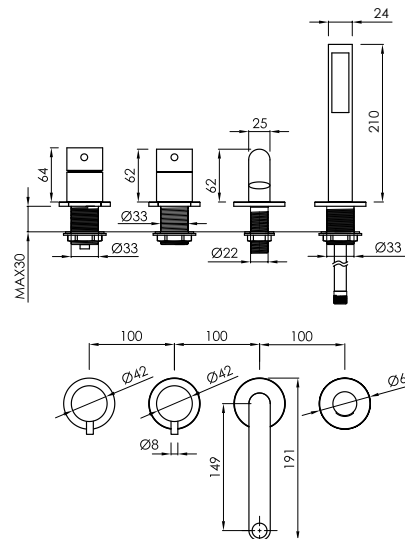

mm



Monomando
Mixer
Mittigeur



Aireador NEOPERL®
NEOPERL® aerator
Aérateur NEOPERL®



Teleducha de latón
Brass handshower
Douchette à main en laiton



Caudal a 3 BAR
Flow rate at 3 BAR
Débit à 3 BAR



Caudal a 3 BAR
Flow rate at 3 BAR
Débit à 3 BAR



Flexo 1,5m
1,5 m hose
Flexible 1,5m

Monomando para borde bañera / Deck mounted mixer for bathtub / Mitigeur au bord pour baignoire

A \ B		CR		BM		MG		NB		BG		RG	
		CR	BM	MG	NB	BG	RG	CR	BM	MG	NB	BG	RG
CR		BNBB011CRCR 539 €	BNBB011CRBM 594 €	BNBB011CRMG 627 €	BNBB011CRNB 627 €	BNBB011CRBG 627 €	BNBB011CRRG 627 €						
BM		BNBB011BMCR 594 €	BNBB011BMBM 600 €	BNBB011BMMG 627 €	BNBB011BMNB 627 €	BNBB011BMBG 627 €	BNBB011BMRG 627 €						
MG		BNBB011MGCR 627 €	BNBB011MGBM 627 €	BNBB011MGMG 627 €	BNBB011MGNB 627 €	BNBB011MGBG 627 €	BNBB011MGRG 627 €						
NB		BNBB011NBCR 627 €	BNBB011NBBM 627 €	BNBB011NBMG 627 €	BNBB011NBNB 627 €	BNBB011NBBG 627 €	BNBB011NBRG 627 €						
BG		BNBB011BGCR 627 €	BNBB011BGBM 627 €	BNBB011BGMG 627 €	BNBB011BGNB 627 €	BNBB011BGBG 627 €	BNBB011BGRG 627 €						
RG		BNBB011RGCR 627 €	BNBB011RGBM 627 €	BNBB011RGMG 627 €	BNBB011RGNB 627 €	BNBB011RGBG 627 €	BNBB011RGRG 627 €						

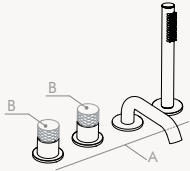

Loop K

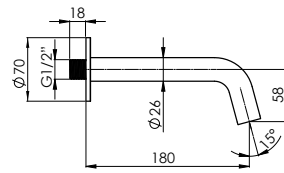

mm



Aireador NEOPERL®
NEOPERL® aerator
Aérateur NEOPERL®

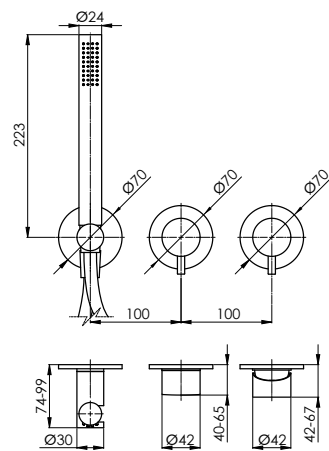

mm



Monomando
Mixer
Mitigeur



Teleducha de latón
Brass handshower
Douchette à main en laiton



Flexo 1,5m PVC
1,5m PVC hose
Flexible 1,5m PVC



2 vías
2 ways
2 voies

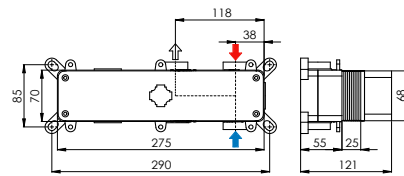

mm



Cuerpo encastre universal
Universal concealed body
Corps d'encastrement universel



Monomando
Mixer
Mitigeur



2 vías
2 ways
2 voies



Caudal a 3 BAR
Flow rate at 3 BAR
Débit à 3 BAR



Caudal a 3 BAR
Flow rate at 3 BAR
Débit à 3 BAR



Conexiones 3/4" hembra latón
Connections 3/4" female brass
Raccordements 3/4" laiton femelle

Loop K

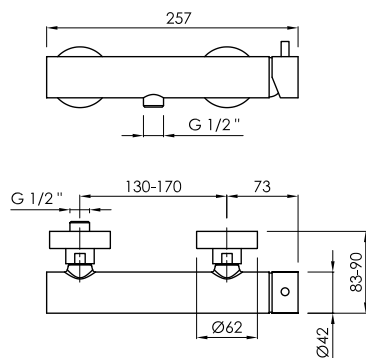

mm



Monomando
Mixer
Mitigeur



Teleducha de latón
Brass handshower
Douchette à main en laiton



Caudal a 3 BAR
Flow rate at 3 BAR
Débit à 3 BAR



Flexo 1,5m PVC
1,5 m PVC hose
Flexible 1,5m PVC

Monomando exterior para ducha / Exposed shower mixer / Mitigeur de douche exterieur

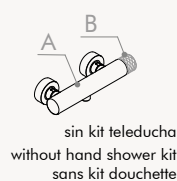

A \ B	CR	BM	MG	NB	BG	RG
CR	MDU011CRCR 253 €	MDU011CRBM 275 €	MDU011CRMG 341 €	MDU011CRNB 341 €	MDU011CRBG 341 €	MDU011CRRG 341 €
BM	MDU011BMCR 275 €	MDU011BMBM 286 €	MDU011BMMG 341 €	MDU011BMNB 341 €	MDU011BMBG 341 €	MDU011BMRG 341 €
MG	MDU011MGCR 341 €	MDU011MGBM 341 €	MDU011MGMG 341 €	MDU011MGNB 341 €	MDU011MGBG 341 €	MDU011MGRG 341 €
NB	MDU011NBCR 341 €	MDU011NBBM 341 €	MDU011NBMG 341 €	MDU011NBNB 341 €	MDU011NBBG 341 €	MDU011NBRG 341 €
BG	MDU011BGCR 341 €	MDU011BGBM 341 €	MDU011BGMG 341 €	MDU011BGNB 341 €	MDU011BGBG 341 €	MDU011BGRG 341 €
RG	MDU011RGCR 341 €	MDU011RGBM 341 €	MDU011RGMG 341 €	MDU011RGNB 341 €	MDU011RGBG 341 €	MDU011RGRG 341 €



A \ B	CR	BM	MG	NB	BG	RG
CR	MDU011CRCRK 363 €	MDU011CRBMK 385 €	MDU011CRMGK 451 €	MDU011CRNBK 451 €	MDU011CRBGK 451 €	MDU011CRRGK 451 €
BM	MDU011BMCRK 385 €	MDU011BMBMK 396 €	MDU011BMMGK 451 €	MDU011BMNBK 451 €	MDU011BMBGK 451 €	MDU011BMRGK 451 €
MG	MDU011MGCRK 451 €	MDU011MGBMK 451 €	MDU011MGMGK 451 €	MDU011MGNBK 451 €	MDU011MGBGK 451 €	MDU011MGRGK 451 €
NB	MDU011NBCRK 451 €	MDU011NBBMK 451 €	MDU011NBMGK 451 €	MDU011NBNBK 451 €	MDU011NBBGK 451 €	MDU011NBRGK 451 €
BG	MDU011BGCRK 451 €	MDU011BGBMK 451 €	MDU011BGMGK 451 €	MDU011BGNBK 451 €	MDU011BGBGK 451 €	MDU011BGRGK 451 €
RG	MDU011RGCRK 451 €	MDU011RGBMK 451 €	MDU011RGMGK 451 €	MDU011RGNBK 451 €	MDU011RGBGK 451 €	MDU011RGRGK 451 €

Loop K

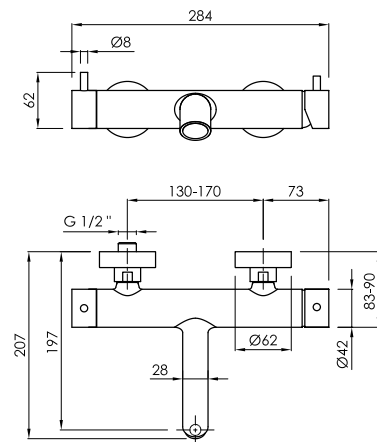

mm



Monomando
Mixer
Mitigeur



Aireador NEOPERL®
NEOPERL® aerator
Aérateur NEOPERL®



Teleducha de latón
Brass handshower
Douchette à main en laiton



Caudal a 3 BAR
Flow rate at 3 BAR
Débit à 3 BAR



Caudal a 3 BAR
Flow rate at 3 BAR
Débit à 3 BAR



Flexo 1,5m PVC
1,5 m PVC hose
Flexible 1,5m PVC

Monomando exterior para baño ducha / Exposed bath-shower mixer / Mitigeur de bain-douche exterieur

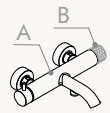

sin kit teleducha
without hand shower kit
sans kit douchette

A \ B	CR	BM	MG	NB	BG	RG
CR	MDB011CRCR 259 €	MDB011CRBM 286 €	MDB011CRMG 369 €	MDB011CRNB 369 €	MDB011CRBG 369 €	MDB011CRRG 369 €
BM	MDB011BMCR 286 €	MDB011BMBM 292 €	MDB011BMMG 369 €	MDB011BMNB 369 €	MDB011BMBG 369 €	MDB011BMRG 369 €
MG	MDB011MGCR 369 €	MDB011MGBM 369 €	MDB011MGMG 369 €	MDB011MGNB 369 €	MDB011MGBG 369 €	MDB011MGRG 369 €
NB	MDB011NBCR 369 €	MDB011NBBM 369 €	MDB011NBMG 369 €	MDB011NBNB 369 €	MDB011NBBG 369 €	MDB011NBRG 369 €
BG	MDB011BGCR 369 €	MDB011BGBM 369 €	MDB011BGMG 369 €	MDB011BGNB 369 €	MDB011BGBG 369 €	MDB011BGRG 369 €
RG	MDB011RGCR 369 €	MDB011RGBM 369 €	MDB011RGMG 369 €	MDB011RGNB 369 €	MDB011RGBG 369 €	MDB011RGRG 369 €

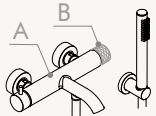

con kit teleducha
with hand shower kit
avec kit douchette

A \ B	CR	BM	MG	NB	BG	RG
CR	MDB011CRCRK 369 €	MDB011CRBMK 396 €	MDB011CRMGK 479 €	MDB011CRNBK 479 €	MDB011CRBGK 479 €	MDB011CRRGK 479 €
BM	MDB011BMCRK 396 €	MDB011BMBMK 402 €	MDB011BMMGK 479 €	MDB011BMNBK 479 €	MDB011BMBGK 479 €	MDB011BMRGK 479 €
MG	MDB011MGCRK 479 €	MDB011MGBMK 479 €	MDB011MGMGK 479 €	MDB011MGNBK 479 €	MDB011MGBGK 479 €	MDB011MGRGK 479 €
NB	MDB011NBCRK 479 €	MDB011NBBMK 479 €	MDB011NBMGK 479 €	MDB011NBNBK 479 €	MDB011NBBGK 479 €	MDB011NBRGK 479 €
BG	MDB011BGCRK 479 €	MDB011BGBMK 479 €	MDB011BGMGK 479 €	MDB011BGNBK 479 €	MDB011BGBGK 479 €	MDB011BGRGK 479 €
RG	MDB011RGCRK 479 €	MDB011RGBMK 479 €	MDB011RGMGK 479 €	MDB011RGNBK 479 €	MDB011RGBGK 479 €	MDB011RGRGK 479 €

Loop K

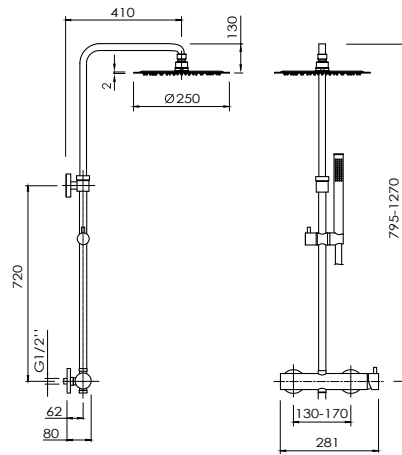

mm



Monomando
Mixer
Mitigeur



Rociador acero inoxidable 2mm
2mm stainless steel showerhead
Douche de tête acier inoxydable
2mm



Altura regulable
Adjustable height
Hauteur réglable



Soporte deslizante y orientable
Sliding and adjustable support
Support coulissant et pivotant



Caudal a 3 BAR
Flow rate at 3 BAR
Débit à 3 BAR



Caudal a 3 BAR
Flow rate at 3 BAR
Débit à 3 BAR



Teleducha de latón
Brass handshower
Douchette à main en laiton



Flexo 1,5m PVC
1,5 m PVC hose
Flexible 1,5m PVC

Columna de ducha monomando / Mixer shower column / Colonne de douche mitigeur

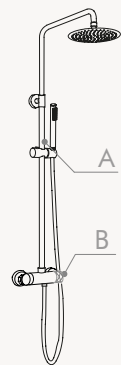

A \ B	CR	BM	MG	NB	BG	RG
CR	COMO011CRCR 363 €	COMO011CRBM 468 €	COMO011CRMG 627 €	COMO011CRNB 627 €	COMO011CRBG 627 €	COMO011CRRG 627 €
BM	COMO011BMCR 468 €	COMO011BMBM 473 €	COMO011BMMG 627 €	COMO011BMNB 627 €	COMO011BMBG 627 €	COMO011BMRG 627 €
MG	COMO011MGCR 627 €	COMO011MGBM 627 €	COMO011MGMG 627 €	COMO011MGNB 627 €	COMO011MGBG 627 €	COMO011MGRG 627 €
NB	COMO011NBCR 627 €	COMO011NBBM 627 €	COMO011NBMG 627 €	COMO011NBNB 627 €	COMO011NBBG 627 €	COMO011NBRG 627 €
BG	COMO011BGCR 627 €	COMO011BGBM 627 €	COMO011BGMG 627 €	COMO011BGNB 627 €	COMO011BGBG 627 €	COMO011BGRG 627 €
RG	COMO011RGCR 627 €	COMO011RGBM 627 €	COMO011RGMG 627 €	COMO011RGNB 627 €	COMO011RGBG 627 €	COMO011RGRG 627 €

Loop K

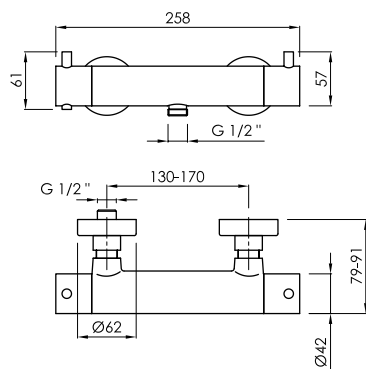

mm



Mezclador termostático
Thermostatic mixer
Mélangeur thermostatique



Sistema **safe touch**
Safe touch body
Sistema **safe touch**



Cartucho termostático SEDAL®
SEDAL® thermostatic cartridge
Cartouche thermostatique
SEDAL®



Teleducha de latón
Brass handshower
Douchette à main en laiton



Caudal a 3 BAR
Flow rate at 3 BAR
Débit à 3 BAR



Antirretornos NEOPERL®
NEOPERL® check valves
Anti-retours NEOPERL®



Flexo 1,5m PVC
1,5 m PVC hose
Flexible 1,5m PVC

Termostático exterior para ducha / Exposed shower thermostatic mixer / Thermostatique de douche exterieur

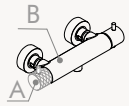

sin kit teleducha
without hand shower kit
sans kit douchette

A \ B	CR	BM	MG	NB	BG	RG
CR	TDU011CRCR 292 €	TDU011CRBM 319 €	TDU011CRMG 396 €	TDU011CRNB 396 €	TDU011CRBG 396 €	TDU011CRRG 396 €
BM	TDU011BMCR 319 €	TDU011BMBM 325 €	TDU011BMMG 396 €	TDU011BMNB 396 €	TDU011BMBG 396 €	TDU011BMRG 396 €
MG	TDU011MGCR 396 €	TDU011MGBM 396 €	TDU011MGMG 396 €	TDU011MGNB 396 €	TDU011MGBG 396 €	TDU011MGRG 396 €
NB	TDU011NBCR 396 €	TDU011NBBM 396 €	TDU011NBMG 396 €	TDU011NBNB 396 €	TDU011NBBG 396 €	TDU011NBRG 396 €
BG	TDU011BGCR 396 €	TDU011BGBM 396 €	TDU011BGMG 396 €	TDU011BGNB 396 €	TDU011BGBG 396 €	TDU011BGRG 396 €
RG	TDU011RGCR 396 €	TDU011RGBM 396 €	TDU011RGMG 396 €	TDU011RGNB 396 €	TDU011RGBG 396 €	TDU011RGRG 396 €

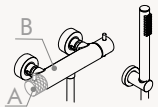

con kit teleducha
with hand shower kit
avec kit douchette

A \ B	CR	BM	MG	NB	BG	RG
CR	TDU011CRCRK 402 €	TDU011CRBMK 429 €	TDU011CRMGK 506 €	TDU011CRNBK 506 €	TDU011CRBGK 506 €	TDU011CRRGK 506 €
BM	TDU011BMCRK 429 €	TDU011BMBMK 435 €	TDU011BMMGK 506 €	TDU011BMNBK 506 €	TDU011BMBGK 506 €	TDU011BMRGK 506 €
MG	TDU011MGCRK 506 €	TDU011MGBMK 506 €	TDU011MGMGK 506 €	TDU011MGNBK 506 €	TDU011MGBGK 506 €	TDU011MGRGK 506 €
NB	TDU011NBCRK 506 €	TDU011NBBMK 506 €	TDU011NBMGK 506 €	TDU011NBNBK 506 €	TDU011NBBGK 506 €	TDU011NBRGK 506 €
BG	TDU011BGCRK 506 €	TDU011BGBMK 506 €	TDU011BGMGK 506 €	TDU011BGNBK 506 €	TDU011BGBGK 506 €	TDU011BGRGK 506 €
RG	TDU011RGCRK 506 €	TDU011RGBMK 506 €	TDU011RGMGK 506 €	TDU011RGNBK 506 €	TDU011RGBGK 506 €	TDU011RGRGK 506 €

Loop K

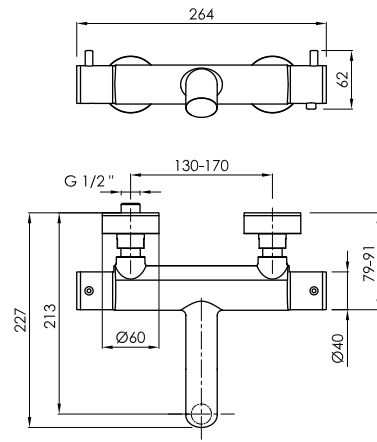

mm



Mezclador termostático
Thermostatic mixer
Mélangeur thermostatique



Cartucho termostático VERNET®
VERNET® thermostatic cartridge
Cartouche thermostatique
VERNET®



Teleducha de latón
Brass handshower
Douchette à main en laiton



Flexo 1,5m PVC
1,5 m PVC hose
Flexible 1,5m PVC



Caudal a 3 BAR
Flow rate at 3 BAR
Débit à 3 BAR



Caudal a 3 BAR
Flow rate at 3 BAR
Débit à 3 BAR



Antirretornos NEOPERL®
NEOPERL® check valves
Anti-retours NEOPERL®

Termostático exterior para baño-ducha / Exposed bath-shower thermostatic mixer / Thermostatique de bain-douche exterieur



A \ B	CR	BM	MG	NB	BG	RG
CR	TDB011CRCR 338 €	TDB011CRBM 369 €	TDB011CRMG 479 €	TDB011CRNB 479 €	TDB011CRBG 479 €	TDB011CRRG 479 €
BM	TDB011BMCR 369 €	TDB011BMBM 374 €	TDB011BMMG 479 €	TDB011BMNB 479 €	TDB011BMBG 479 €	TDB011BMRG 479 €
MG	TDB011MGCR 479 €	TDB011MGBM 479 €	TDB011MGMG 479 €	TDB011MGNB 479 €	TDB011MGBG 479 €	TDB011MGRG 479 €
NB	TDB011NBCR 479 €	TDB011NBBM 479 €	TDB011NBMG 479 €	TDB011NB NB 479 €	TDB011NBBG 479 €	TDB011NBRG 479 €
BG	TDB011BGCR 479 €	TDB011BGBM 479 €	TDB011BGMG 479 €	TDB011BGNB 479 €	TDB011BGBG 479 €	TDB011BGRG 479 €
RG	TDB011RGCR 479 €	TDB011RGBM 479 €	TDB011RGMG 479 €	TDB011RGNB 479 €	TDB011RGBG 479 €	TDB011RGRG 479 €

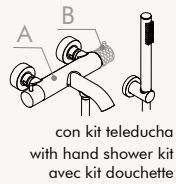

A \ B	CR	BM	MG	NB	BG	RG
CR	TDB011CRCRK 448 €	TDB011CRBMK 479 €	TDB011CRMGK 589 €	TDB011CRNBK 589 €	TDB011CRBGK 589 €	TDB011CRRGK 589 €
BM	TDB011BMCRK 479 €	TDB011BMBMK 484 €	TDB011BMMGK 589 €	TDB011BMNBK 589 €	TDB011BMBGK 589 €	TDB011BMRGK 589 €
MG	TDB011MGCRK 589 €	TDB011MGBMK 589 €	TDB011MGMGK 589 €	TDB011MGNBK 589 €	TDB011MGBGK 589 €	TDB011MGRGK 589 €
NB	TDB011NBCRK 589 €	TDB011NBBMK 589 €	TDB011NBMGK 589 €	TDB011NB NBK 589 €	TDB011NBBGK 589 €	TDB011NBRGK 589 €
BG	TDB011BGCRK 589 €	TDB011BGBMK 589 €	TDB011BGMGK 589 €	TDB011BGNBK 589 €	TDB011BGBGK 589 €	TDB011BGRGK 589 €
RG	TDB011RGCRK 589 €	TDB011RGBMK 589 €	TDB011RGMGK 589 €	TDB011RGNBK 589 €	TDB011RGBGK 589 €	TDB011RGRGK 589 €

Loop K

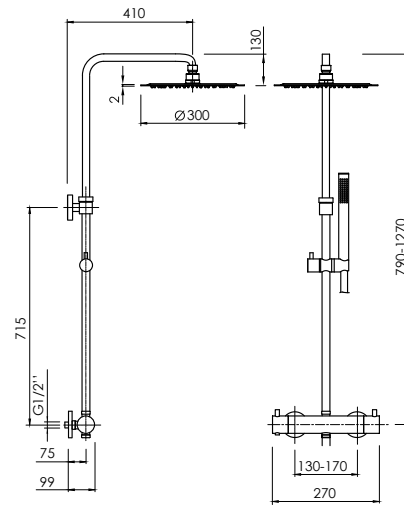

mm



Mezclador termostático
Thermostatic mixer
Mélangeur thermostatique



Rociador acero inoxidable 2mm
2mm stainless steel showerhead
Douche de tête acier inoxydable 2mm



Cartucho termostático VERNET®
VERNET® thermostatic cartridge
Cartouche thermostatique VERNET®



Altura regulable
Adjustable height
Hauteur réglable



Soporte deslizante y orientable
Sliding and adjustable support
Support coulissant et pivotant



Caudal a 3 BAR
Flow rate at 3 BAR
Débit à 3 BAR



Caudal a 3 BAR
Flow rate at 3 BAR
Débit à 3 BAR



Teleducha de latón
Brass handshower
Douchette à main en laiton



Flexo 1,5m PVC
1,5 m PVC hose
Flexible 1,5m PVC

Columna de ducha termostática / Thermostatic shower column / Colonne de douche thermostatique

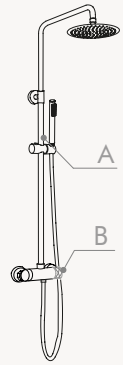

A \ B	CR	BM	MG	NB	BG	RG
CR	COTE011CRCR 506 €	COTE011CRBM 605 €	COTE011CRMG 649 €	COTE011CRNB 649 €	COTE011CRBG 649 €	COTE011CRRG 649 €
BM	COTE011BMCR 605 €	COTE011BMBM 611 €	COTE011BMMG 649 €	COTE011BMNB 649 €	COTE011BMBG 649 €	COTE011BMRG 649 €
MG	COTE011MGCR 649 €	COTE011MGBM 649 €	COTE011MGMG 649 €	COTE011MGNB 649 €	COTE011MGBG 649 €	COTE011MGRG 649 €
NB	COTE011NBCR 649 €	COTE011NBBM 649 €	COTE011NBMG 649 €	COTE011NBNB 649 €	COTE011NBBG 649 €	COTE011NBRG 649 €
BG	COTE011BGCR 649 €	COTE011BGBM 649 €	COTE011BGMG 649 €	COTE011BGNB 649 €	COTE011BGBG 649 €	COTE011BGRG 649 €
RG	COTE011RGCR 649 €	COTE011RGBM 649 €	COTE011RGMG 649 €	COTE011RGNB 649 €	COTE011RGBG 649 €	COTE011RGRG 649 €

Loop K

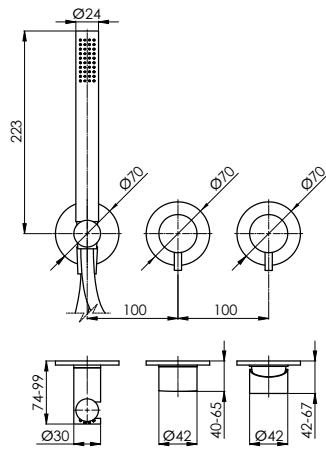

mm



Monomando
Mixer
Mitigeur



Teleducha de latón
Brass handshower
Douchette à main en laiton



2 vías
2 ways
2 voies



Flexo 1,5m PVC
1,5m PVC hose
Flexible 1,5m PVC

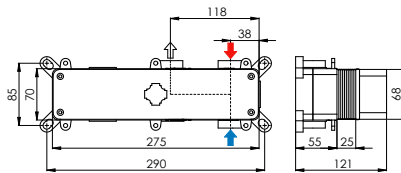

mm



Cuerpo encastre universal
Universal concealed body
Corps d'encastrement universel



Monomando
Mixer
Mitigeur



2 vías
2 ways
2 voies



Caudal a 3 BAR
Flow rate at 3 BAR
Débit à 3 BAR



Caudal a 3 BAR
Flow rate at 3 BAR
Débit à 3 BAR



Conexiones 3/4" hembra latón
Connections 3/4" female brass
Raccordements 3/4" laiton femelle

Monomando de ducha mural horizontal de 2 vías / Wall-mounted shower mixer 2 ways / Mitigeur de douche mural 2 voies

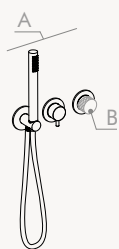

A \ B	CR	BM	MG	NB	BG	RG
CR	MH2D011CRCR 287 €	MH2D011CRBM 298 €	MH2D011CRMG 310 €	MH2D011CRNB 310 €	MH2D011CRBG 310 €	MH2D011CRRG 310 €
BM	MH2D011BMCR 398 €	MH2D011BMBM 409 €	MH2D011BMMG 440 €	MH2D011BMNB 440 €	MH2D011BMBG 440 €	MH2D011BMRG 440 €
MG	MH2D011MGCR 440 €	MH2D011MGBM 440 €	MH2D011MGMG 440 €	MH2D011MGNB 440 €	MH2D011MGBG 440 €	MH2D011MGRG 440 €
NB	MH2D011NBCR 440 €	MH2D011NBBM 440 €	MH2D011NBMG 440 €	MH2D011NBNB 440 €	MH2D011NBBG 440 €	MH2D011NBRG 440 €
BG	MH2D011BGCR 440 €	MH2D011BGBM 440 €	MH2D011BGMG 440 €	MH2D011BGNB 440 €	MH2D011BGBG 440 €	MH2D011BGRG 440 €
RG	MH2D011RGCR 440 €	MH2D011RGBM 440 €	MH2D011RGMG 440 €	MH2D011RGNB 440 €	MH2D011RGBG 440 €	MH2D011RGRG 440 €

sanybox para monomando horizontal 2 vías mural / Horizontal wall-mounted mixer 2 way sanybox / sanybox pour mitigeur horizontal 2 voies mural

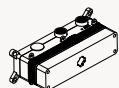

MH2000

230 €

* Las griferías murales contemplan solo la parte externa, el pedido debe acompañarse con el cuerpo de empotrar sanybox correspondiente.

* Wall-mounted faucets only include the external part, the order must be accompanied by the corresponding concealed body sanybox.

* Les robinets muraux ne sont que pour la partie extérieure, la commande doit être accompagnée du corps encastré sanybox correspondant.

Loop K

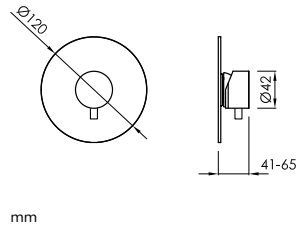

Monomando
Mixer
Mitigeur



1 vía
1 way
1 voie

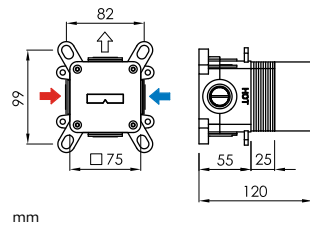

Cuerpo de encastre universal
Universal concealed body
Corps d'encastrement universel



Monomando
Mixer
Mitigeur



Cartucho KEROX
KEROX cartridge
Cartouche KEROX



Caudal a 3 BAR
Flow rate at 3 BAR
Débit à 3 BAR



1 vía
1 way
1 voie



Conexiones 1/2" hembra latón
Connections 1/2" female brass
Raccordements 1/2" laiton femelle

Monomando de ducha mural 1 vía / Wall-mounted shower mixer 1 way / Mitigeur de douche mural 1 voie

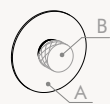

A \ B	CR	BM	MG	NB	BG	RG
CR	ME1011CRCR 127 €* <hr/>	ME1011CRBM 171 €* <hr/>	ME1011CRMG 209 €* <hr/>	ME1011CRNB 209 €* <hr/>	ME1011CRBG 209 €* <hr/>	ME1011CRRG 209 €* <hr/>
BM	ME1011BMCR 171 €* <hr/>	ME1011BMBM 176 €* <hr/>	ME1011BMMG 209 €* <hr/>	ME1011BMNB 209 €* <hr/>	ME1011BMBG 209 €* <hr/>	ME1011BMRG 209 €* <hr/>
MG	ME1011MGCR 209 €* <hr/>	ME1011MGBM 209 €* <hr/>	ME1011MGMG 209 €* <hr/>	ME1011MGNB 209 €* <hr/>	ME1011MGBG 209 €* <hr/>	ME1011MGRG 209 €* <hr/>
NB	ME1011NBCR 209 €* <hr/>	ME1011NBBM 209 €* <hr/>	ME1011NBMG 209 €* <hr/>	ME1011NBNB 209 €* <hr/>	ME1011NBBG 209 €* <hr/>	ME1011NBRG 209 €* <hr/>
BG	ME1011BGCR 209 €* <hr/>	ME1011BGBM 209 €* <hr/>	ME1011BGMG 209 €* <hr/>	ME1011BGNB 209 €* <hr/>	ME1011BGBG 209 €* <hr/>	ME1011BGRG 209 €* <hr/>
RG	ME1011RGCR 209 €* <hr/>	ME1011RGBM 209 €* <hr/>	ME1011RGMG 209 €* <hr/>	ME1011RGNB 209 €* <hr/>	ME1011RGBG 209 €* <hr/>	ME1011RGRG 209 €* <hr/>

Loop K

sanybox para monomando ducha mural 1 vía / Wall-mounted shower mixer 1 way sanybox / sanybox pour mitigeur de douche mural 1 voie



ME1000

95 €

* Las griferías murales contemplan solo la parte externa, el pedido debe acompañarse con el cuerpo de empotrar sanybox correspondiente.

* Wall-mounted faucets only include the external part, the order must be accompanied by the corresponding concealed body sanybox.

* Les robinets muraux ne sont que pour la partie extérieure, la commande doit être accompagnée du corps encastré sanybox correspondant.

Loop K

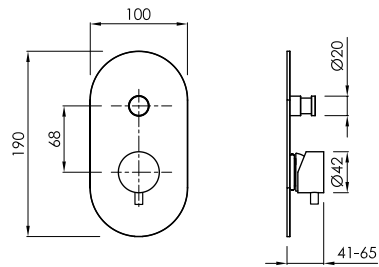

mm



Monomando
Mixer
Mitigeur



2 vías
2 ways
2 voies

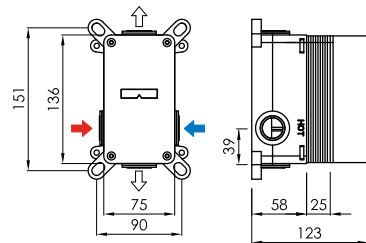

mm



Cuerpo de encastre universal
Universal concealed body
Corps d'encastrement universel



Monomando
Mixer
Mitigeur



Cartucho KEROX
KEROX cartridge
Cartouche KEROX



Caudal a 3 BAR
Flow rate at 3 BAR
Débit à 3 BAR



2 vías
2 ways
2 voies



Conexiones 1/2" hembra latón
Connections 1/2" female brass
Raccordements 1/2" laiton femelle

Monomando de ducha mural 2 vías / Wall-mounted shower mixer 2 ways / Mitigeur de douche mural 2 voies

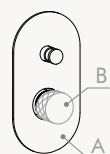

A \ B	CR	BM	MG	NB	BG	RG
CR	ME2011CRCR 141 €* -----	ME2011CRBM 204 €* -----	ME2011CRMG 242 €* -----	ME2011CRNB 242 €* -----	ME2011CRBG 242 €* -----	ME2011CRRG 242 €* -----
BM	ME2011BMCR 204 €* -----	ME2011BMBM 209 €* -----	ME2011BMMG 242 €* -----	ME2011BMNB 242 €* -----	ME2011BMBG 242 €* -----	ME2011BMRG 242 €* -----
MG	ME2011MGCR 242 €* -----	ME2011MGBM 242 €* -----	ME2011MGMG 242 €* -----	ME2011MGNB 242 €* -----	ME2011MGBG 242 €* -----	ME2011MGRG 242 €* -----
NB	ME2011NBCR 242 €* -----	ME2011NBBM 242 €* -----	ME2011NBMG 242 €* -----	ME2011NB NB 242 €* -----	ME2011NBBG 242 €* -----	ME2011NBRG 242 €* -----
BG	ME2011BGCR 242 €* -----	ME2011BGBM 242 €* -----	ME2011BGMG 242 €* -----	ME2011BGNB 242 €* -----	ME2011BGBG 242 €* -----	ME2011BGRG 242 €* -----
RG	ME2011RGCR 242 €* -----	ME2011RGBM 242 €* -----	ME2011RGMG 242 €* -----	ME2011RGNB 242 €* -----	ME2011RGBG 242 €* -----	ME2011RGRG 242 €* -----

sanybox para monomando ducha mural 2 vías / Wall-mounted shower mixer 2 way sanybox / sanybox pour mitigeur de douche mural 2 voies

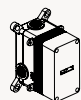

ME2000

115 €

* Las griferías murales contemplan solo la parte externa, el pedido debe acompañarse con el cuerpo de empotrar sanybox correspondiente.

* Wall-mounted faucets only include the external part, the order must be accompanied by the corresponding concealed body sanybox.

* Les robinets muraux ne sont que pour la partie extérieure, la commande doit être accompagnée du corps encastré sanybox correspondant.

Loop K

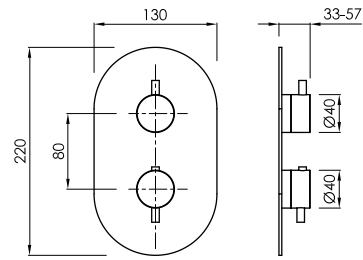

mm



Mezclador termostático
Thermostatic mixer
Melangeur thermostatique



1 vía
1 way
1 voie



2 y 3 vías
2 & 3 ways
2 et 3 voies

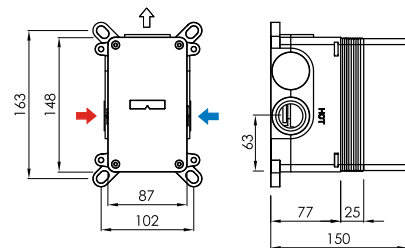

mm



Cuerpo de encastre universal
Universal concealed body
Corps d'encastrement universel



Mezclador termostático
Thermostatic mixer
Melangeur thermostatique



Cartucho termostático VERNET®
VERNET® thermostatic cartridge
Cartouche thermostatique VERNET®



Caudal a 3 BAR
Flow rate at 3 BAR
Débit à 3 BAR



1 vía
1 way
1 voie



Conexiones 3/4" hembra latón
Connections 3/4" female brass
Raccordements 3/4" laiton femelle

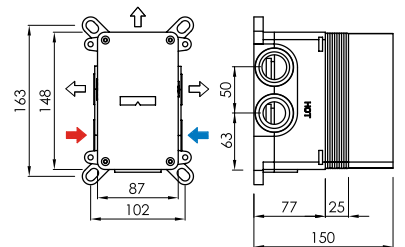

mm



Cuerpo de encastre universal
Universal concealed body
Corps d'encastrement universel



Mezclador termostático
Thermostatic mixer
Melangeur thermostatique



Cartucho termostático VERNET®
VERNET® thermostatic cartridge
Cartouche thermostatique VERNET®



Caudal a 3 BAR
Flow rate at 3 BAR
Débit à 3 BAR



2 y 3 vías
2 & 3 ways
2 et 3 voies



Conexiones 3/4" hembra latón
Connections 3/4" female brass
Raccordements 3/4" laiton femelle

Termostático de ducha mural 1-2-3 vías / Wall-mounted shower thermostatic mixer 1-2-3 ways / Thermostatique de douche mural 1-2-3 voies

A \ B	CR	BM	MG	NB	BG	RG
CR	T13011CRCR 193 €* <hr/>	T13011CRBM 303 €* <hr/>	T13011CRMG 385 €* <hr/>	T13011CRNB 385 €* <hr/>	T13011CRBG 385 €* <hr/>	T13011CRRG 385 €* <hr/>
BM	T13011BMCR 303 €* <hr/>	T13011BMBM 308 €* <hr/>	T13011BMMG 385 €* <hr/>	T13011BMNB 385 €* <hr/>	T13011BMBG 385 €* <hr/>	T13011BMRG 385 €* <hr/>
MG	T13011MGCR 385 €* <hr/>	T13011MGBM 385 €* <hr/>	T13011MGMG 385 €* <hr/>	T13011MGNB 385 €* <hr/>	T13011MGBG 385 €* <hr/>	T13011MGRG 385 €* <hr/>
NB	T13011NBCR 385 €* <hr/>	T13011NBBM 385 €* <hr/>	T13011NBMG 385 €* <hr/>	T13011NBNB 385 €* <hr/>	T13011NBBG 385 €* <hr/>	T13011NBRG 385 €* <hr/>
BG	T13011BGCR 385 €* <hr/>	T13011BGBM 385 €* <hr/>	T13011BGMG 385 €* <hr/>	T13011BGNB 385 €* <hr/>	T13011BGBG 385 €* <hr/>	T13011BGRG 385 €* <hr/>
RG	T13011RGCR 385 €* <hr/>	T13011RGBM 385 €* <hr/>	T13011RGMG 385 €* <hr/>	T13011RGNB 385 €* <hr/>	T13011RGBG 385 €* <hr/>	T13011RGRG 385 €* <hr/>

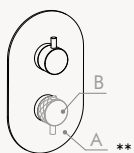

sanybox termostático de ducha mural 1 vía / Wall-mounted shower thermostatic mixer 1 way sanybox / sanybox thermostatique de douche mural 1voie



TE1000
193 €

sanybox termostático de ducha mural 2-3 vías / Wall-mounted shower thermostatic mixer 2-3 ways sanybox / sanybox thermostatique de douche mural 2-3 voies



TE3000
209 €

* Las griferías murales contemplan solo la parte externa, el pedido debe acompañarse con el cuerpo de empotrar sanybox correspondiente.

** Artículo compatible con sanybox termostático de 1 vía y con sanybox termostático de 2-3 vías.

* Wall-mounted faucets only include the external part, the order must be accompanied by the corresponding concealed body sanybox.

** Article compatible with 1-way thermostatic sanybox and 2-3-way thermostatic sanybox.

* Les robinets muraux ne sont que pour la partie extérieure, la commande doit être accompagnée du corps encastré sanybox correspondant.

** Article compatible avec le sanybox thermostatique à 1 voie et le sanybox thermostatique à 2 ou 3 voies.



Cubo



Cubo

La serie Cubo presenta líneas contundentes a la vez que fluidas para un mayor confort del usuario. Sus volúmenes arquitectónicos se convierten en protagonistas en cualquier espacio.

En acabado cromo brillo y negro mate, clasicismo atemporal vs vanguardia.

Cubo series presents forceful and at the same time fluid lines for increased user comfort. Its blunt and architectural volumes become protagonists in any space.

In bright chrome and matt black finish, timeless classicism vs. avant-garde.

La série Cubo présente des lignes solides et fluides à la fois pour un meilleur confort des utilisateurs. Leurs volumes de caractère et architecturaux en deviennent les protagonistes dans n'importe quel espace.

Dans une finition chromée éclatante et noir mat, classicisme intemporel vs avant-garde.



Cubo



Monomando
Single lever
Mitigeur



MNO002CR
Chrome



Cubo



Monomando
Single lever
Mitigeur



MEN002BM

Black Matt

MEN000

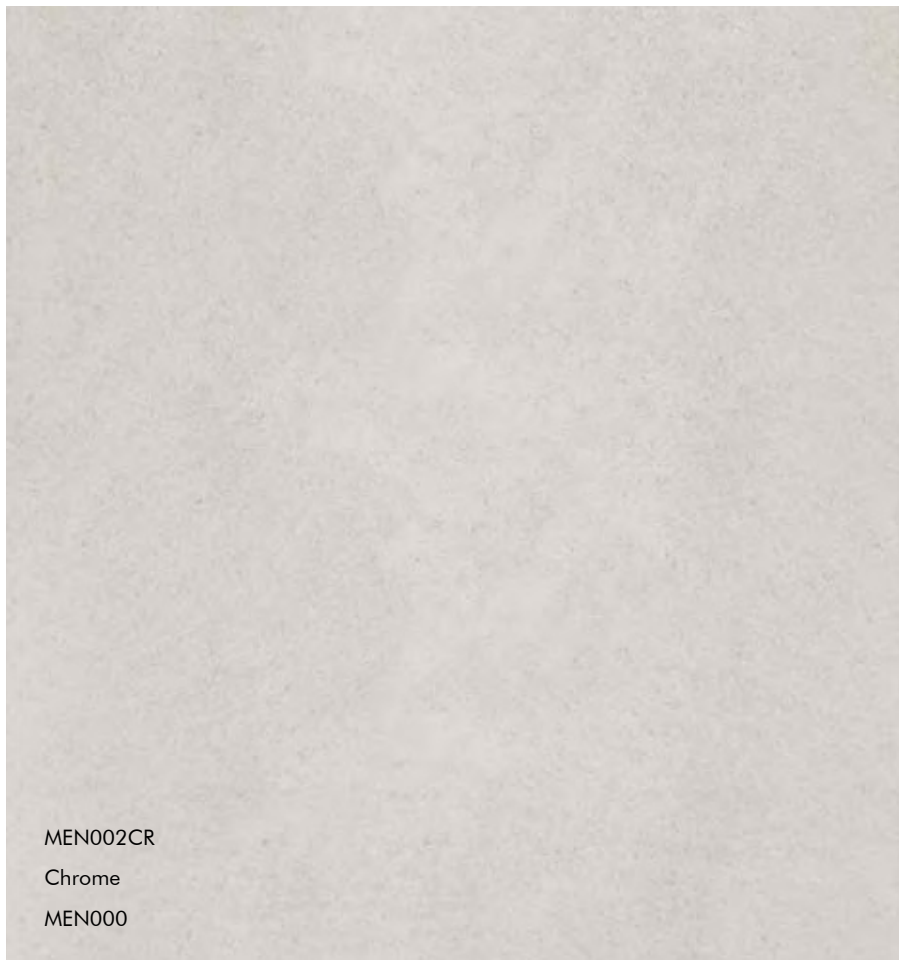

MEN002CR

Chrome

MEN000



Cubo



Monomando
Single lever
Mitigeur





BAR00270CR
TEL002CR
FLE010CR
TOM002CR
ME1002CR
Chrome
ME1000

Cubo



Monomando
Single lever
Mitigeur

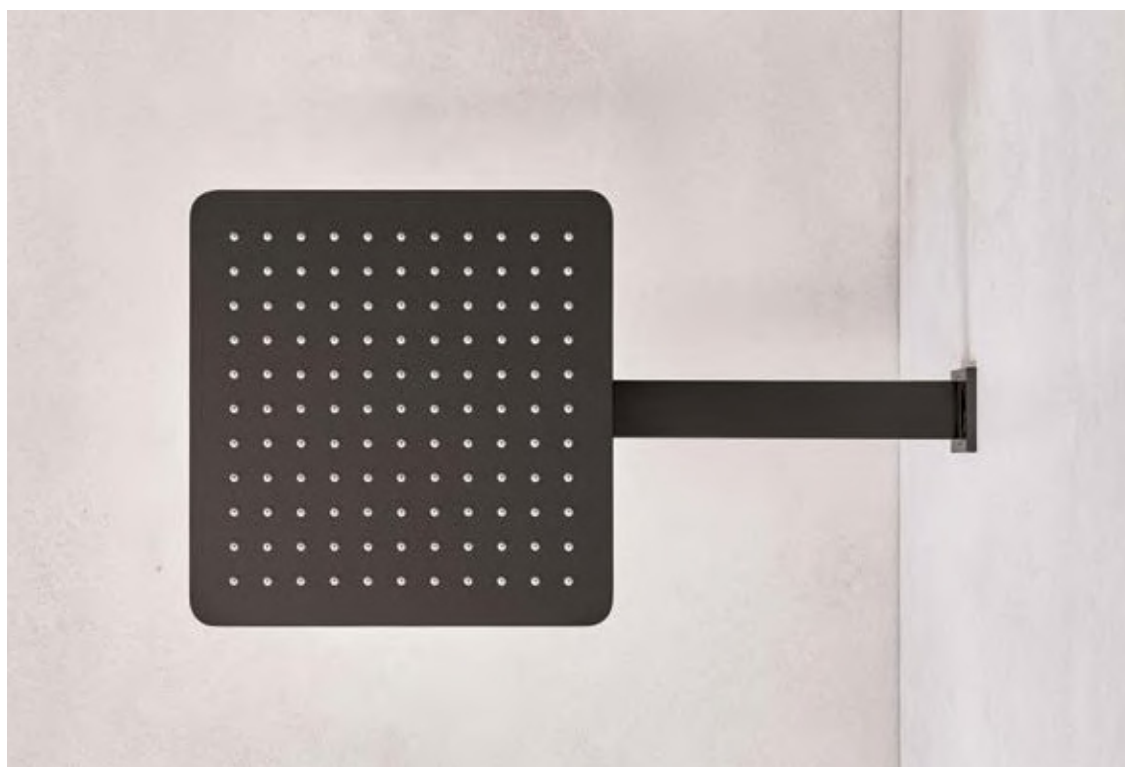

ROC002BM
BRP002BM
TEL002BM
FLE010BM
STM002BM
ME2002BM
Black Matt
ME2000



Cubo



Termostática
Thermostatic mixer
Thermostatique



T13002CR
Chrome
TE1000/TE3000



TEL002CR
FLE010CR
STM002CR
Chrome



Cubo



Termostática
Thermostatic mixer
Thermostatique



TDU002CR
Chrome



TDB002CR
Chrome





Cubo



Monomando
Single lever
Mitigeur



COMO002BM
Black Matt



Termostática
Thermostatic mixer
Thermostatique



Cubo 

COTE002BM
Black Matt

Cubo



Monomando
Single lever
Mitigeur





BNEX002CR
Chrome

Cubo



Bimando
Double handle
Double poignée



BNBB002BM
Black Matt



Cubo



Monomando de lavabo
Basin mixer
Mitigeur de lavabo
p. 159



Monomando alto de lavabo
High basin mixer
Mitigeur haut de lavabo
p. 159



Monomando de bidé
Bidet mixer
Mitigeur de bidet
p. 159

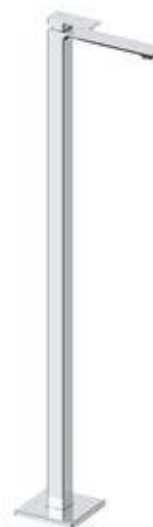

Monomando exento de lavabo
Freestanding basin mixer
Mitigeur de pied de lavabo
p. 161



Monomando de lavabo mural
Wall-mounted basin mixer
Mitigeur de lavabo mural
p. 161



sanybox para monomando lavabo mural
Wall-mounted basin mixer **sanybox**
sanybox pour mitigeur de lavabo mural
p. 161



Grifería de pie para bañera
Freestanding faucet for bathtub
Robinetterie de pied pour baignoire
p. 163



Bimando borde bañera
Deck mounted double handle mixer for bathtub
Mitigeur double poignée au bord pour baignoire
p. 163



Monomando exterior para ducha
Exposed shower mixer
Mitigeur de douche exterieur
p. 165



Monomando exterior para baño-
ducha
Exposed bath-shower mixer
Mitigeur de bain-douche exterieur
p. 165



Columna de ducha monomando
Mixer shower column
Colonne de douche mitigeur
p. 165



Termostático exterior para ducha
Exposed shower thermostatic mixer
Thermostatique de douche exterieur
p. 167



Termostático exterior para baño-
ducha
Exposed bath-shower thermostatic
mixer
Thermostatique de bain-douche
exterieur
p. 167



Columna de ducha termostática
Thermostatic shower column
Colonne de douche
thermostatique
p. 167

Cubo



Cubo kit monomando mural ducha rociador + teleducha

Cubo kit wall-mounted shower mixer showerhead + handshower

Cubo kit mitigeur de douche mural douche de tête + douchette

p. 169

Cubo kit termoestático mural ducha rociador + teleducha

Cubo kit wall-mounted thermostatic shower mixer showerhead + handshower

Cubo kit thermostatique de douche mural douche de tête + douchette

p. 169



Monomando de ducha mural 1 vía

Wall-mounted shower mixer 1 way

Mitigeur de douche mural 1 voie

p. 171

sanybox para monomando de ducha mural 1 vía

Wall-mounted shower mixer 1 way

sanybox pour mitigeur de douche mural 1 voie

p. 171

Monomando de ducha mural 2 vías

Wall-mounted shower mixer 2 ways

Mitigeur de douche mural 2 voies

p. 171

sanybox para monomando de ducha mural 2 vías

Wall-mounted shower mixer 2 way **sanybox**

sanybox pour mitigeur de douche mural 2 voies mural

p. 171



Termoestático de ducha mural 1-2-3 vías

Wall-mounted shower thermostatic mixer 1-2-3 ways

Thermostatique de douche mural 1-2-3 voies

p. 173

sanybox para termoestático de ducha mural 1 vía

Wall-mounted shower thermostatic mixer 1 way **sanybox**

sanybox pour thermostatique de douche mural 1 voie

p. 173

sanybox para termoestático de ducha mural 2-3 vías

Wall-mounted shower thermostatic mixer 2-3 ways **sanybox**

sanybox pour thermostatique de douche mural 2-3 voies

p. 173



Rociador de ducha 25x25cm
25x25cm shower head
Douche de tête 25x25cm
p. 158



Brazo de ducha mural
Wall shower arm
Bras de douche mural
p. 158



Brazo de ducha a techo
Ceiling shower arm
Bras de douche au plafond
p. 158



Barra de ducha deslizable metálica
Metal sliding shower bar
Barre de douche coulissante
métallique
p. 177



Teleducha
Hand shower
Douchette
p. 177



Flexo de ducha
Flexible hose
Flexible de douche
p. 177



Soporte de teleducha a pared fijo
Hand shower fixed wall support
Support mural fixe pour douchette
p. 179



Soporte de teleducha a pared orientable
Hand shower swivel wall support
Support mural pivotante pour douchette
p. 179



Soporte de teleducha con toma de agua a pared fijo
Hand shower fixed wall support with water outlet
Support mural fixe pour douchette avec sortie
p. 179



Toma de agua mural
Wall shower outlet
Coude de sortie mural
p. 179

Cubo

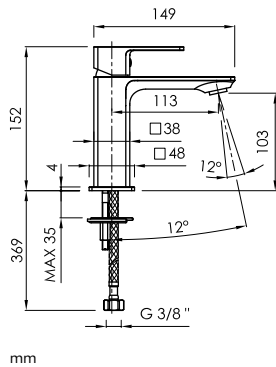

Apertura en frío
Cold open
Ouverture en eau froide



Ahorro de energía
Energy saving
Économie d'énergie



Aireador orientable NEOPERL®
NEOPERL® adjustable aerator
Aérateur réglable NEOPERL®



Para válvula click clack
For pop-up waste
Pour bonde click-clack



Caudal a 3 BAR
Flow rate at 3 BAR
Débit à 3 BAR



Cartucho SEDAL®
SEDAL® cartridge
Cartouche SEDAL®



Latiguillos TUCAI®
TUCAI® hoses
Flexible TUCAI®



Válvula no incluida
Waste not included
Bonde non incluse

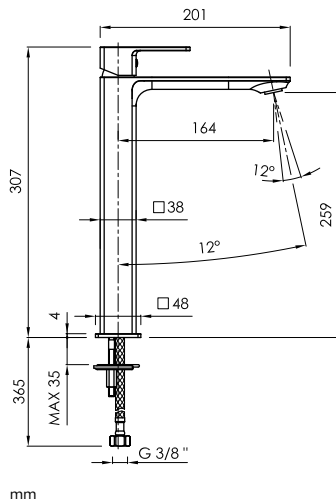

Apertura en frío
Cold open
Ouverture en eau froide



Ahorro de energía
Energy saving
Économie d'énergie



Aireador orientable NEOPERL®
NEOPERL® adjustable aerator
Aérateur réglable NEOPERL®



Para válvula click clack
For pop-up waste
Pour bonde click-clack



Caudal a 3 BAR
Flow rate at 3 BAR
Débit à 3 BAR



Cartucho SEDAL®
SEDAL® cartridge
Cartouche SEDAL®



Latiguillos TUCAI®
TUCAI® hoses
Flexible TUCAI®



Válvula no incluida
Waste not included
Bonde non incluse

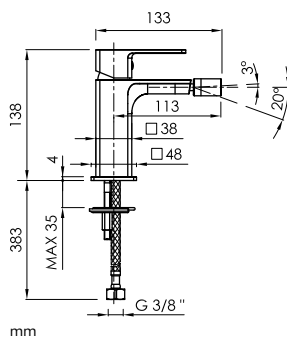

Apertura en frío
Cold open
Ouverture en eau froide



Ahorro de energía
Energy saving
Économie d'énergie



Aireador orientable NEOPERL®
NEOPERL® adjustable aerator
Aérateur réglable NEOPERL®



Para válvula click clack
For pop-up waste
Pour bonde click-clack



Caudal a 3 BAR
Flow rate at 3 BAR
Débit à 3 BAR



Cartucho SEDAL®
SEDAL® cartridge
Cartouche SEDAL®



Latiguillos TUCAI®
TUCAI® hoses
Flexible TUCAI®



Válvula no incluida
Waste not included
Bonde non incluse

Monomando de lavabo / Basin mixer / Mitigeur de lavabo



	
CR	BM
MNO002CR	MNO002BM
154 €	187 €

Monomando alto de lavabo / High basin mixer / Mitigeur haut de lavabo



	
CR	BM
MOA002CR	MOA002BM
253 €	297 €

Monomando de bidé / Bidet mixer / Mitigeur de bidet



	
CR	BM
MBD002CR	MBD002BM
160 €	193 €

Cubo

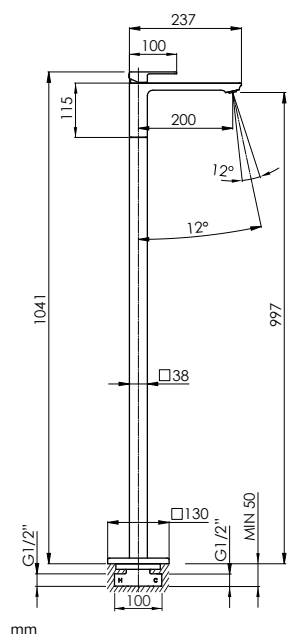

mm



Apertura en frío
Cold open
Ouverture en eau froide



Ahorro de energía
Energy saving
Économie d'énergie



Aireador NEOPERL®
NEOPERL® aerator
Aérateur NEOPERL®



Caudal a 3 BAR
Flow rate at 3 BAR
Débit à 3 BAR



Cartucho SEDAL®
SEDAL® cartridge
Cartouche SEDAL®

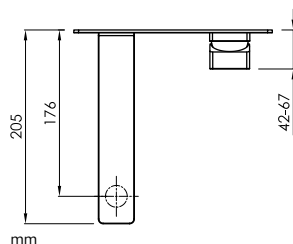
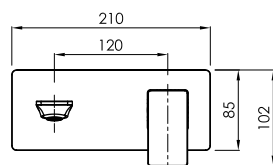

mm



Apertura en frío
Cold open
Ouverture en eau froide



Ahorro de energía
Energy saving
Économie d'énergie



Aireador orientable NEOPERL®
NEOPERL® adjustable aerator
Aérateur réglable NEOPERL®



Caudal a 3 BAR
Flow rate at 3 BAR
Débit à 3 BAR



Cartucho KEROX
KEROX cartridge
Cartouche KEROX

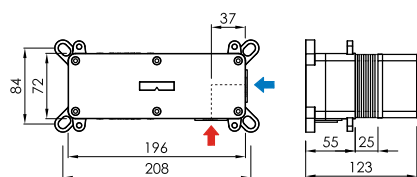

mm



Cuerpo encastre universal
Universal concealed body
Corps d'encastrement universel



Ahorro de energía
Energy saving
Économie d'énergie



Apertura en frío
Cold open
Ouverture en eau froide



Conexiones 1/2" hembra latón
Connections 1/2" female brass
Raccordements 1/2" laiton femelle

Monomando exento de lavabo / Freestanding basin mixer / Mitigeur sur pied de lavabo

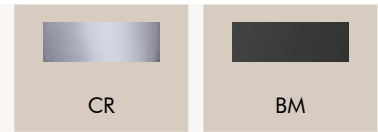
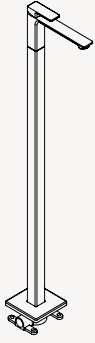

MEX002CR

MEX002BM

750 €

990 €

Monomando de lavabo mural / Wall-mounted basin mixer / Mitigeur de lavabo mural

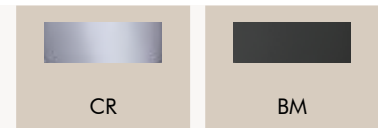
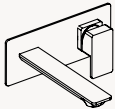

MEN002CR

MEN002BM

176 €*

259 €*

sanybox para monomando lavabo mural / Wall-mounted basin mixer sanybox / sanybox pour mitigeur de lavabo mural



MEN000

140 €

* Las griferías murales contemplan solo la parte externa, el pedido debe acompañarse con el cuerpo de empotrar **sanybox** correspondiente.

* Wall-mounted faucets only include the external part, the order must be accompanied by the corresponding concealed body **sanybox**.

* Les robinets muraux ne sont que pour la partie extérieure, la commande doit être accompagnée du corps encastré **sanybox** correspondant.

Grifería de pie para bañera / Freestanding faucet for bathtub / Robinetterie de pied pour baignoire

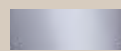
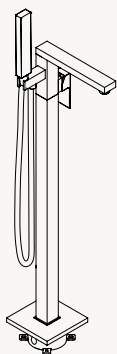

CR

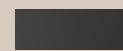

BM

BNEX002CR

1.067 €

BNEX002BM

1.276 €

Bimando borde bañera / Deck mounted double handle mixer for bathtub / Mitigeur double poignée au bord pour baignoire

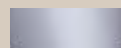
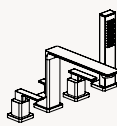

CR

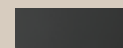

BM

BNBB002CR

578 €

BNBB002BM

660 €

Cubo

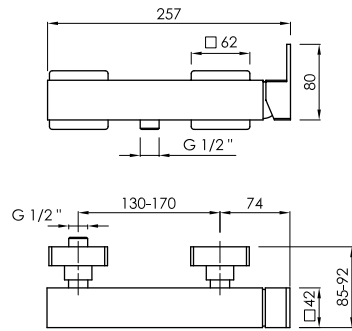

mm



Monomando
Mixer
Mitigeur



Teleducha de latón
Brass handshower
Douchette à main en laiton



Flexo de PVC
PVC hose
Flexible PVC



Caudal a 3 BAR
Flow rate at 3 BAR
Débit à 3 BAR



Flexo 1,5m
1,5 m hose
Flexible 1,5m

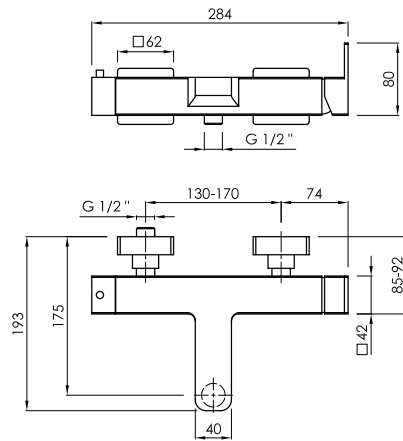

mm



Monomando
Mixer
Mitigeur



Aireador NEOPERL®
NEOPERL® aerator
Aérateur NEOPERL®



Teleducha de latón
Brass handshower
Douchette à main en laiton



Flexo de PVC
PVC hose
Flexible PVC



Caudal a 3 BAR
Flow rate at 3 BAR
Débit à 3 BAR



Caudal a 3 BAR
Flow rate at 3 BAR
Débit à 3 BAR



Flexo 1,5m
1,5 m hose
Flexible 1,5m

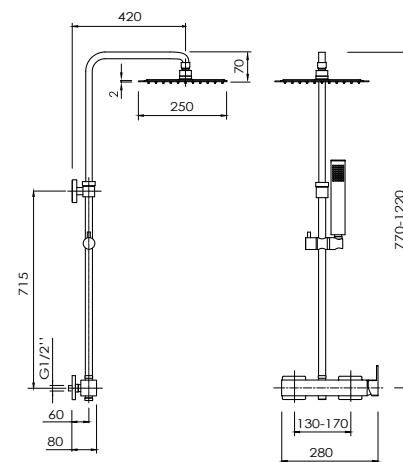

mm



Monomando
Mixer
Mitigeur



Rociador acero inoxidable 2mm
2mm stainless steel showerhead
Douche de tête acier inoxydable
2mm



Altura regulable
Adjustable height
Hauteur réglable



Flexo de PVC
PVC hose
Flexible PVC



Soporte deslizante y orientable
Sliding and adjustable support
Support coulissant et pivotant



Caudal a 3 BAR
Flow rate at 3 BAR
Débit à 3 BAR



Caudal a 3 BAR
Flow rate at 3 BAR
Débit à 3 BAR



Teleducha de ABS
ABS handshower
Douchette à main en ABS



Flexo 1,5m
1,5 m hose
Flexible 1,5m

Monomando exterior para ducha / Exposed shower mixer / Mitigeur de douche exterieur

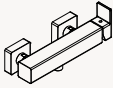
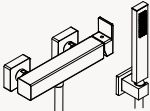
		CR	BM
sin kit teleducha without hand shower kit sans kit douchette		MDU002CR 176 €	MDU002BM 198 €
con kit teleducha with hand shower kit avec kit douchette		MDU002CRK 308 €	MDU002BMK 330 €

Cubo 

Monomando exterior para baño ducha / Exposed bath-shower mixer / Mitigeur de bain-douche exterieur

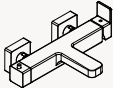
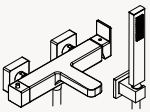
		CR	BM
sin kit teleducha without hand shower kit sans kit douchette		MDB002CR 215 €	MDB002BM 242 €
con kit teleducha with hand shower kit avec kit douchette		MDB002CRK 325 €	MDB002BMK 352 €

Columna de ducha monomando / Mixer shower column / Colonne de douche mitigeur

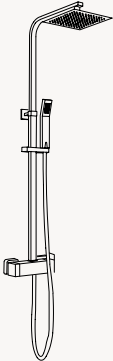
		CR	BM
		COMET721 314 €	COMO002BM 418 €

Cubo

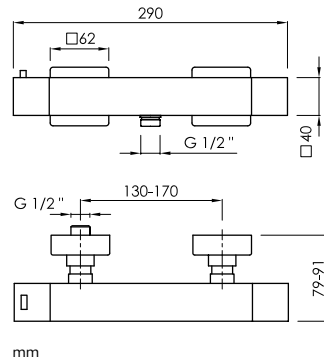

Mezclador termostático
Thermostatic mixer
Melangeur thermostatique



Sistema safe touch
Safe touch body
Sistema safe touch



Cartucho termostático SEDAL®
SEDAL® thermostatic cartridge
Cartouche thermostatique
SEDAL®



Teleducha de latón
Brass handshower
Douchette à main en laiton



Caudal a 3 BAR
Flow rate at 3 BAR
Débit à 3 BAR



Antirretornos NEOPERL®
NEOPERL® check valves
Anti-retours NEOPERL®



Flexo 1,5m PVC
1,5 m PVC hose
Flexible 1,5m PVC

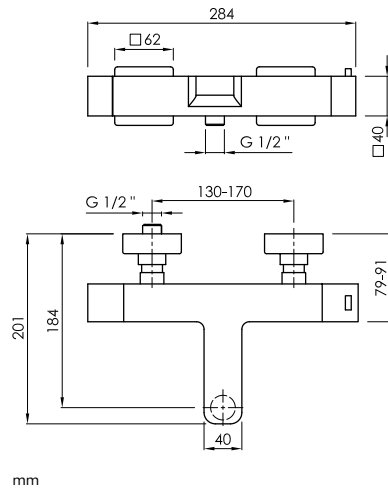

Mezclador termostático
Thermostatic mixer
Melangeur thermostatique



Cartucho termostático SEDAL®
SEDAL® thermostatic cartridge
Cartouche thermostatique
SEDAL®



Teleducha de latón
Brass handshower
Douchette à main en laiton



Caudal a 3 BAR
Flow rate at 3 BAR
Débit à 3 BAR



Caudal a 3 BAR
Flow rate at 3 BAR
Débit à 3 BAR



Antirretornos NEOPERL®
NEOPERL® check valves
Anti-retours NEOPERL®



Flexo 1,5m PVC
1,5 m PVC hose
Flexible 1,5m PVC

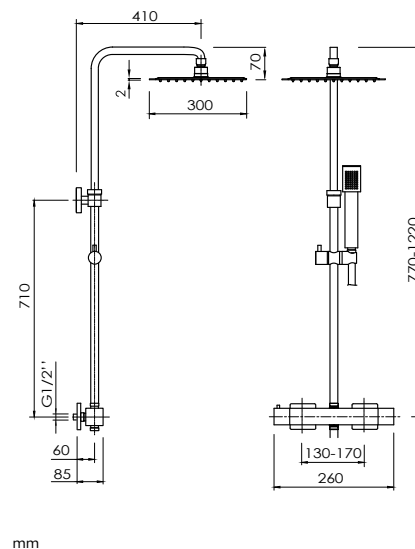

Mezclador termostático
Thermostatic mixer
Melangeur thermostatique



Rociador acero inoxidable 2mm
2mm stainless steel showerhead
Douche de tête acier inoxydable
2mm



Cartucho termostático VERNET®
VERNET® thermostatic cartridge
Cartouche thermostatique
VERNET®



Altura regulable
Adjustable height
Hauteur réglable



Soporte deslizante y orientable
Sliding and adjustable support
Support coulissant et pivotant



Caudal a 3 BAR
Flow rate at 3 BAR
Débit à 3 BAR



Caudal a 3 BAR
Flow rate at 3 BAR
Débit à 3 BAR



Teleducha de ABS
ABS handshower
Douchette à main en ABS



Flexo 1,5m PVC
1,5 m PVC hose
Flexible 1,5m PVC

Termostático exterior para ducha / Exposed shower thermostatic mixer / Thermostatique de douche exterieur

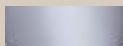
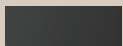
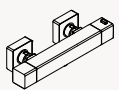
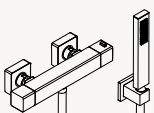
			
		CR	BM
sin kit teleducha without hand shower kit sans kit douchette		TDU002CR 275 €	TDU002BM 319 €
con kit teleducha with hand shower kit avec kit douchette		TDU002CRK 385 €	TDU002BMK 429 €

Cubo 

Termostático exterior para baño-ducha / Exposed bath-shower thermostatic mixer / Thermostatique de bain-douche exterieur

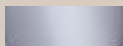
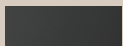
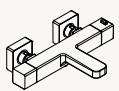
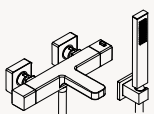
			
		CR	BM
sin kit teleducha without hand shower kit sans kit douchette		TDB002CR 319 €	TDB002BM 363 €
con kit teleducha with hand shower kit avec kit douchette		TDB002CRK 429 €	TDB002BMK 473 €

Columna de ducha termostática / Thermostatic shower column / Colonne de douche thermostatique

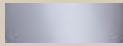
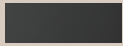
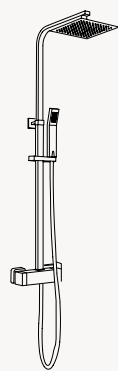
			
		CR	BM
		COMET723 439 €	COTE002BM 495 €

Cubo

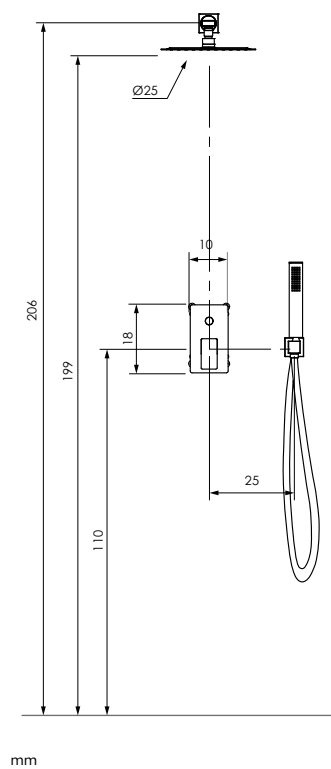

mm



Cuerpo encastre universal
Universal concealed body
Corps d'encastrement universel



Monomando
Mixer
Mitigeur



Cartucho KEROX
KEROX cartridge
Cartouche KEROX



Rociador acero inoxidable 2mm
2mm stainless steel showerhead
Douhe de tête acier inoxydable 2mm



Tetinas antical
Anti-limescale nozzles
Télines anti-calcaire



Latón
Brass
Laiton



Flexo 1,5m PVC
1,5 m PVC hose
Flexible 1,5m PVC



2 vías
2 ways
2 voies



Conexiones 1/2" hembra latón
Connections 1/2" female brass
Raccordements 1/2" laiton femelle



Limitador de caudal
Flow restrictor
Limiteur de débit



Caudal a 3 BAR
Flow rate at 3 BAR
Débit à 3 BAR



Ahorro de agua
Water saving
Économie de l'eau



Teleducha de latón
Brass handshower
Douchette à main en laiton



Sistema anti-torsión
Anti-twist
Système anti-torsion

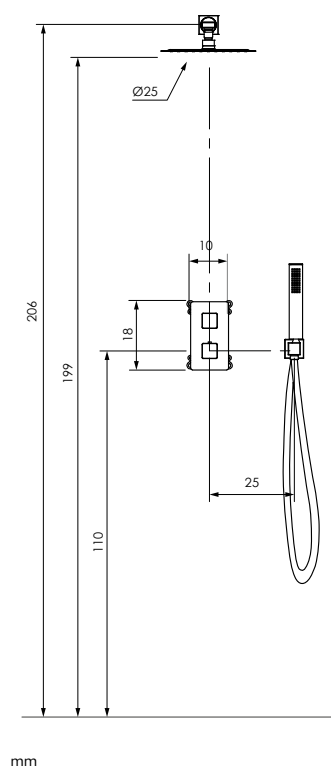

mm



Cuerpo encastre universal
Universal concealed body
Corps d'encastrement universel



Mezclador termostático
Thermostatic mixer
Melangeur thermostatique



Cartucho termostático VERNET®
VERNET® thermostatic cartridge
Cartouche thermostatique VERNET®



Rociador acero inoxidable 2mm
2mm stainless steel showerhead
Douhe de tête acier inoxydable 2mm



Tetinas antical
Anti-limescale nozzles
Télines anti-calcaire



Latón
Brass
Laiton



Flexo 1,5m PVC
1,5 m PVC hose
Flexible 1,5m PVC



Caudal a 3 BAR
Flow rate at 3 BAR
Débit à 3 BAR



2 y 3 vías
2 & 3 ways
2 et 3 voies



Conexiones 1/2" hembra latón
Connections 1/2" female brass
Raccordements 1/2" laiton femelle



Limitador de caudal
Flow restrictor
Limiteur de débit



Ahorro de agua
Water saving
Économie de l'eau



Teleducha de latón
Brass handshower
Douchette à main en laiton



Sistema anti-torsión
Anti-twist
Système anti-torsion

Cubo kit monomando mural ducha rociador + teleducha
 Cubo kit wall-mounted shower mixer showerhead + handshower
 Cubo kit mitigeur de douche mural douche de tête + douchette

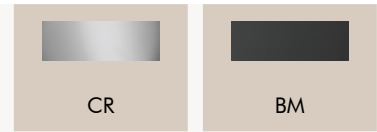
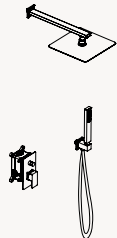

ME2002CRK

ME2002BMK

523 €

694 €

Cubo kit monomando mural

- Monomando de ducha mural 2 vías
- **sanybox** para monomando de ducha mural 2 vías
- Rociador de ducha
- Brazo de ducha mural
- Soporte fijo de teleducha con toma de agua a pared
- Teleducha
- Flexo de ducha

Cubo kit wall-mounted shower mixer

- Wall-mounted shower mixer 2 ways
- Wall-mounted shower mixer 2 way **sanybox**
- Shower head
- Wall shower arm
- Hand shower fixed wall support with water outlet
- Hand shower
- Flexible hose

Cubo kit mitigeur de douche mural

- Mitigeur de douche mural 2 voies
- **sanybox** pour mitigeur de douche mural 2 voies
- Douche de tête
- Bras de douche mural
- Support mural fixe pour douchette avec sortie-Douchette
- Flexible de douche

Cubo kit termoestático mural ducha rociador + teleducha
 Cubo kit wall-mounted thermostatic shower mixer showerhead + handshower
 Cubo kit thermostatique de douche mural douche de tête + douchette

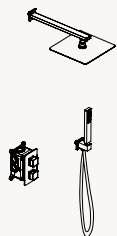

TE3002CRK

TE3002BMK

672 €

876 €

Cubo kit termostático mural

- Termostático de ducha mural 1-2-3 vías
- **sanybox** termostático de ducha mural 2-3 vías
- Rociador de ducha
- Brazo de ducha mural
- Soporte fijo de teleducha con toma de agua a pared
- Teleducha
- Flexo de ducha

Cubo kit wall-mounted thermostatic shower mixer

- Wall-mounted shower thermostatic 1-2-3 ways
- Wall-mounted shower thermostatic mixer 2-3 ways **sanybox**
- Shower head
- Wall shower arm
- Hand shower fixed wall support with water outlet
- Hand shower
- Flexible hose

Cubo kit thermostatique de douche mural

- Thermostatique de douche mural 1-2-3 voies
- **sanybox** thermostatique de douche mural 2-3 voies
- Douche de tête
- Bras de douche mural
- Support mural fixe pour douchette avec sortie
- Douchette
- Flexible de douche

Cubo

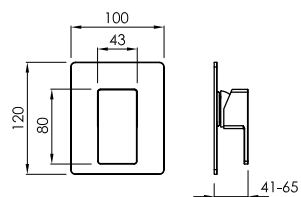

mm



Monomando
Mixer
Mitigeur



1 vía
1 way
1 voie

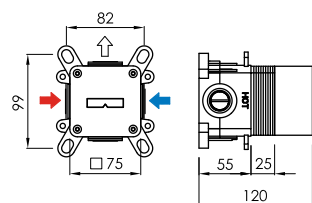

mm



Cuerpo encastre universal
Universal concealed body
Corps d'encastrement universel



Monomando
Mixer
Mitigeur



Cartucho KEROX
KEROX cartridge
Cartouche KEROX



Caudal a 3 BAR
Flow rate at 3 BAR
Débit à 3 BAR



1 vía
1 way
1 voie



Conexiones 1/2" hembra latón
Connections 1/2" female brass
Raccordements 1/2" laiton femelle

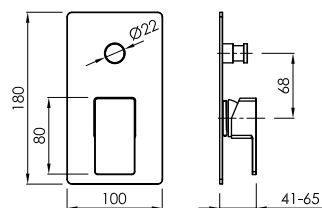

mm



Monomando
Mixer
Mitigeur



2 vías
2 ways
2 voies

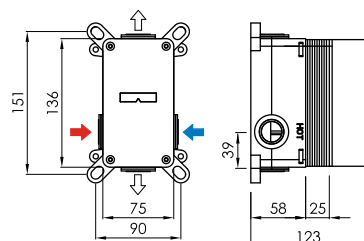

mm



Cuerpo encastre universal
Universal concealed body
Corps d'encastrement universel



Monomando
Mixer
Mitigeur



Cartucho KEROX
KEROX cartridge
Cartouche KEROX



Caudal a 3 BAR
Flow rate at 3 BAR
Débit à 3 BAR



2 vías
2 ways
2 voies



Conexiones 1/2" hembra latón
Connections 1/2" female brass
Raccordements 1/2" laiton femelle

Monomando de ducha mural 1 vía / Wall-mounted shower mixer 1 way / Mitigeur de douche mural 1 voie

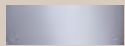

	
CR	BM
ME1002CR	ME1002BM
77 €*	121 €*

sanybox para monomando de ducha mural 1 vía / Wall-mounted shower mixer 1 way sanybox / sanybox pour mitigeur de douche mural 1 voie



ME1000
95 €

Cubo 

Monomando de ducha mural 2 vías / Wall-mounted shower mixer 2 ways / Mitigeur de douche mural 2 voies

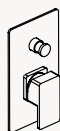

	
CR	BM
ME2002CR	ME2002BM
99 €*	182 €*

sanybox para monomando de ducha mural 2 vías / Wall-mounted shower mixer 2 way sanybox / sanybox pour mitigeur de douche mural 2 voies

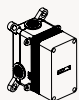

ME2000
115 €

* Las griferías murales contemplan solo la parte externa, el pedido debe acompañarse con el cuerpo de empotrar sanybox correspondiente.

* Wall-mounted faucets only include the external part, the order must be accompanied by the corresponding concealed body sanybox.

* Les robinets muraux ne sont que pour la partie extérieure, la commande doit être accompagnée du corps encastré sanybox correspondant.

Cubo

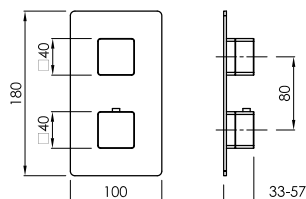

mm



Mezclador termostático
Thermostatic mixer
Melangeur thermostatique



1 vía
1 way
1 voie



2 y 3 vías
2 & 3 ways
2 et 3 voies

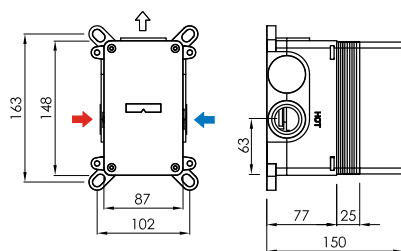

mm



Cuerpo encastre universal
Universal concealed body
Corps d'encastrement universel



Mezclador termostático
Thermostatic mixer
Melangeur thermostatique



Cartucho termostático VERNET®
VERNET® thermostatic cartridge
Cartouche thermostatique VERNET®



Caudal a 3 BAR
Flow rate at 3 BAR
Débit à 3 BAR



1 vía
1 way
1 voie



Conexiones 3/4" hembra latón
Connections 3/4" female brass
Raccordements 3/4" laiton femelle

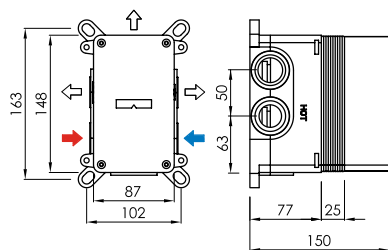

mm



Cuerpo encastre universal
Universal concealed body
Corps d'encastrement universel



Mezclador termostático
Thermostatic mixer
Melangeur thermostatique



Cartucho termostático VERNET®
VERNET® thermostatic cartridge
Cartouche thermostatique VERNET®



Caudal a 3 BAR
Flow rate at 3 BAR
Débit à 3 BAR





2 y 3 vías
2 & 3 ways
2 et 3 voies

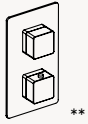

Conexiones 3/4" hembra latón
Connections 3/4" female brass
Raccordements 3/4" laiton femelle

Termostático de ducha mural 1-2-3 vías / Wall-mounted shower thermostatic mixer 1-2-3 ways / Thermostatique de douche mural 1-2-3 voies



	
CR	BM
T13002CR	T13002BM
154 €*	270 €*

sanybox termostático de ducha mural 1 vía / Wall-mounted shower thermostatic mixer 1 way sanybox / sanybox thermostatique de douche mural 1voie



TE1000

193 €*

sanybox termostático de ducha mural 2-3 vías / Wall-mounted shower thermostatic mixer 2-3 ways sanybox / sanybox thermostatique de douche mural 2-3 voies



TE3000

209 €*

* Las griferías murales contemplan solo la parte externa, el pedido debe acompañarse con el cuerpo de empotrar **sanybox** correspondiente.

** Artículo compatible con **sanybox** termostático de 1 vía y con **sanybox** termostático de 2-3 vías.

* Wall-mounted faucets only include the external part, the order must be accompanied by the corresponding concealed body **sanybox**.

** Article compatible with 1-way thermostatic **sanybox** and 2-3-way thermostatic **sanybox**.

* Les robinets muraux ne sont que pour la partie extérieure, la commande doit être accompagnée du corps encastré **sanybox** correspondant.

** Article compatible avec le **sanybox** thermostatique à 1 voie et le **sanybox** thermostatique à 2 ou 3 voies.

Cubo

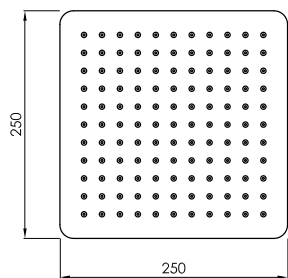
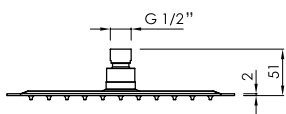

mm



Rociador acero inoxidable 2mm
2mm stainless steel showerhead
Douche de tête acier inoxydable
2mm



Tetinas antical
Anti-limescale nozzles
Télines anti-calcaire



Limitador de caudal
Flow restrictor
Limiteur de débit



Ahorro de agua
Water saving
Économie de l'eau

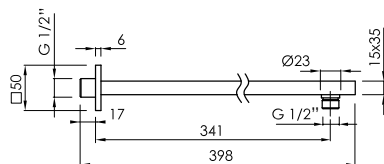

mm



Latón
Brass
Laiton

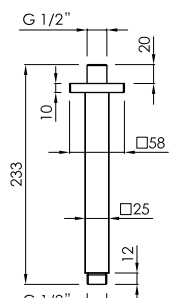

mm



Latón
Brass
Laiton

Rociador de ducha / Shower head / Douche de tête

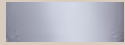

	
CR	BM
ROC002CR	ROC002BM
94 €	132 €

Braço de ducha mural / Wall shower arm / Bras de douche mural

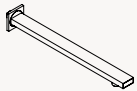

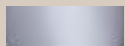
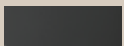
	
CR	BM
BRP00240CR	BRP00240BM
83 €	99 €

Braço de ducha a tecto / Ceiling shower arm / Bras de douche au plafond

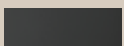

	
CR	BM
BRT00220CR	BRT00220BM
55 €	66 €

Cubo

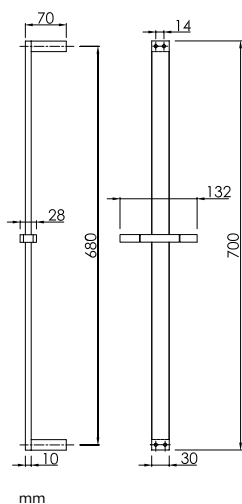

mm



Soporte deslizante y orientable
Sliding and adjustable support
Support coulissant et pivotant



Teleducha no incluida
Hand shower not included
Douchette non incluse



Barra deslizante metálica
Metal sliding shower bar
Barre de douche métallique

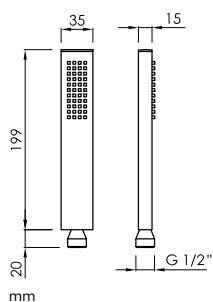

mm



Teleducha de latón
Brass handshower
Douchette à main en laiton



Tetinas antica
Anti-limescale nozzles
Têtes anti-calcaire



Flexo de PVC
PVC hose
Flexible PVC



1,5 m
1,5 m
1,5 m



Sistema anti-torsión
Anti-twist
Système anti-torsion

Barra de ducha deslizante / Sliding shower bar / Barre de douche coulissante

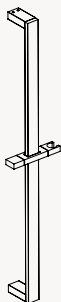

BAR00270CR

BAR00270BM

121 €

176 €

Teleducha / Hand shower / Douchette



TEL002CR

TEL002BM

42 €

55 €

Flexo de ducha / Flexible hose / Flexible de douche



FLE010CR

FLE010BM

32 €

35 €

Cubo

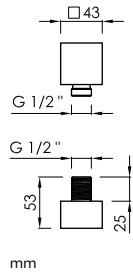
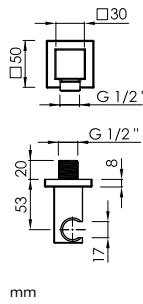
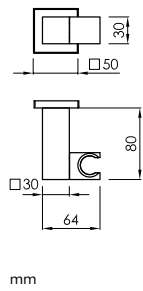
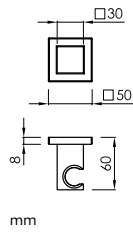

Soporte de teleducha a pared fijo / Hand shower fixed wall support / Support mural fixe pour douchette

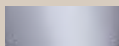
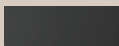

	
CR	BM
SOP002CR	SOP002BM
53 €	68 €

Soporte de teleducha a pared orientable / Hand shower swivel wall support / Support mural pivotante pour douchette



	
CR	BM
SOO002CR	SOO002BM
57 €	75 €

Cubo 

Soporte de teleducha con toma de agua a pared fijo / Hand shower fixed wall support with water outlet / Support mural fixe pour douchette avec sortie



	
CR	BM
STM002CR	STM002BM
58 €	76 €

Toma de agua mural / Wall shower outlet / Coude de sortie mural



	
CR	BM
TOM002CR	TOM002BM
39 €	48 €



Air



Air



Air

Air presenta un diseño diferenciador. Su cuerpo cilíndrico se une con el caño rectangular en un encuentro único. Su maneta ultra-slim le aporta un carácter ligero que no deja indiferente. Disponible en cromo brillo y negro mate para monomandos de lavabo, bidé y grifería borde bañera.

Air presents a distinctive design. Its cylindrical body joins the rectangular pipe in a unique encounter. Its ultra-slim handle adds a slight character that does not leave you indifferent. Available in bright chrome and matt black for mixer wash basin, bidet and bath edge fittings.

Air présente un design différencié. Son corps cylindrique se joint au bec rectangulaire dans une combinaison unique. Sa poignée ultra-mince lui apporte un caractère léger qui ne laisse pas indifférent. Disponible en chrome éclatant et noir mat pour les mitigeurs d'évier, de bidet et du robinet de bord de baignoire.



Air

Air



Monomando
Single lever
Mitigeur



MNO003BM
Black Matt



Air



Monomando
Single lever
Mitigeur



MNO003CR
Chrome



Air



Monomando de lavabo
Basin mixer
Mitigeur de lavabo
p. 191



Monomando alto de lavabo
High basin mixer
Mitigeur haut de lavabo
p. 191



Monomando de bidé
Bidet mixer
Mitigeur de bidet
p. 191



Monomando borde bañera
Deck mounted mixer for bathtub
Mitigeur au bord pour baignoire
p. 193

Air

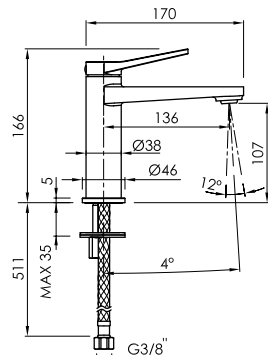

mm



Apertura en frío
Cold open
Ouverture en eau froide



Ahorro de energía
Energy saving
Économie d'énergie



Aireador orientable NEOPERL®
NEOPERL® adjustable aerator
Aérateur réglable NEOPERL®



Para válvula click clack
For pop-up waste
Pour bonde click-clack



Caudal a 3 BAR
Flow rate at 3 BAR
Débit à 3 BAR



Cartucho CITEC
CITEC cartridge
Cartouche CITEC



Latiguillos TUCAI®
TUCAI® hoses
Tuyau TUCAI®



Válvula no incluida
Waste not included
Bonde non incluse

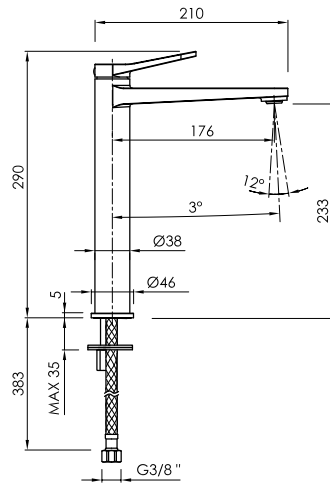

mm



Apertura en frío
Cold open
Ouverture en eau froide



Ahorro de energía
Energy saving
Économie d'énergie



Aireador orientable NEOPERL®
NEOPERL® adjustable aerator
Aérateur réglable NEOPERL®



Para válvula click clack
For pop-up waste
Pour bonde click-clack



Caudal a 3 BAR
Flow rate at 3 BAR
Débit à 3 BAR



Cartucho CITEC
CITEC cartridge
Cartouche CITEC



Latiguillos TUCAI®
TUCAI® hoses
Tuyau TUCAI®



Válvula no incluida
Waste not included
Bonde non incluse

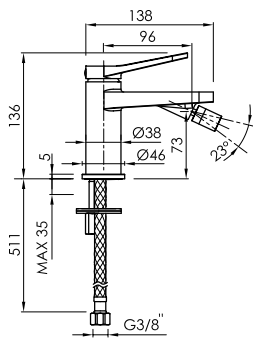

mm



Apertura en frío
Cold open
Ouverture en eau froide



Ahorro de energía
Energy saving
Économie d'énergie



Aireador orientable NEOPERL®
NEOPERL® adjustable aerator
Aérateur réglable NEOPERL®



Para válvula click clack
For pop-up waste
Pour bonde click-clack



Caudal a 3 BAR
Flow rate at 3 BAR
Débit à 3 BAR



Cartucho CITEC
CITEC cartridge
Cartouche CITEC



Latiguillos TUCAI®
TUCAI® hoses
Tuyau TUCAI®



Válvula no incluida
Waste not included
Bonde non incluse

Monomando de lavabo / Basin mixer / Mitigeur de lavabo



	
CR	BM
MNO003CR	MNO003BM
145 €	168 €

Monomando alto de lavabo / High basin mixer / Mitigeur haut de lavabo

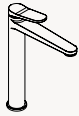

	
CR	BM
MOA003CR	MOA003BM
212 €	259 €

Air

Monomando de bidé / Bidet mixer / Mitigeur de bidet

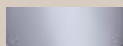

	
CR	BM
MBD003CR	MBD003BM
145 €	168 €

Air

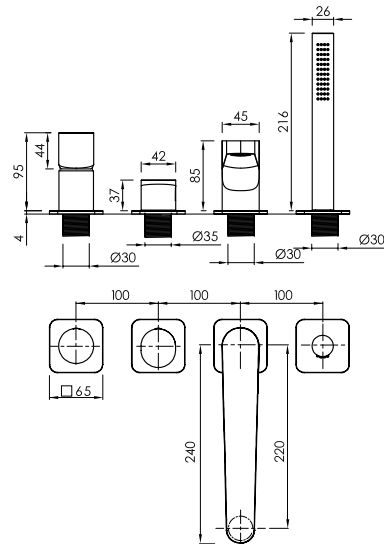

mm



Monomando
Mixer
Mittigeur



Aireador NEOPERL®
NEOPERL® aerator
Aérateur NEOPERL®



Teleducha de latón
Brass handshower
Douchette à main en laiton



Caudal a 3 BAR
Flow rate at 3 BAR
Débit à 3 BAR



Caudal a 3 BAR
Flow rate at 3 BAR
Débit à 3 BAR



Flexo 1,5m
1,5 m hose
Flexible 1,5m

Monomando borde bañera / Deck mounted mixer for bathtub / Mitigeur au bord pour baignoire

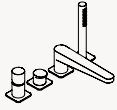

	
CR	BM
BNBB003CR	BNBB003BM
600 €	711 €



Project

Project



Monomando
Single lever
Mitigeur





MNO004CR
Chrome

Project



Monomando de lavabo
Basin mixer
Mitigeur de lavabo
p. 201



Monomando de bidé
Bidet mixer
Mitigeur de bidet
p. 201



Monomando exterior para ducha
Exposed shower mixer
Mitigeur de douche exterieur
p. 203



Monomando exterior para baño-
ducha
Exposed bath-shower mixer
Mitigeur de bain-douche exterieur
p. 203

Project

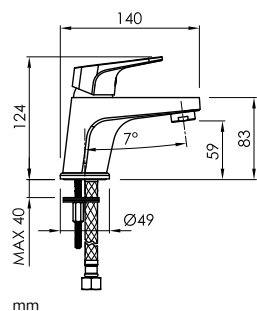

Monomando
Mixer
Mittigeur



Aireador NEOPERL®
NEOPERL® aerator
Aérateur NEOPERL®



Para válvula click clack
For pop-up waste
Pour bonde click-clack



Caudal a 3 BAR
Flow rate at 3 BAR
Débit à 3 BAR



Válvula no incluída
Waste not included
Bonde non incluse

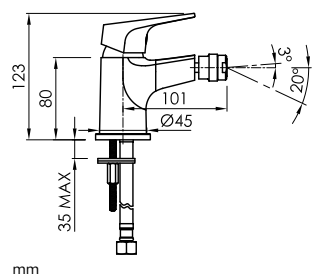

Monomando
Mixer
Mittigeur



Aireador NEOPERL®
NEOPERL® aerator
Aérateur NEOPERL®



Para válvula click clack
For pop-up waste
Pour bonde click-clack



Caudal a 3 BAR
Flow rate at 3 BAR
Débit à 3 BAR



Válvula no incluída
Waste not included
Bonde non incluse

Monomando de lavabo / Basin mixer / Mitigeur de lavabo

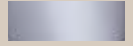

CR

MNO004CR

90 €

Monomando de bidé / Bidet mixer / Mitigeur de bidet

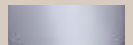

CR

MBD004CR

90 €

Project

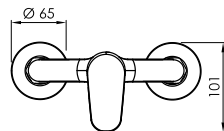
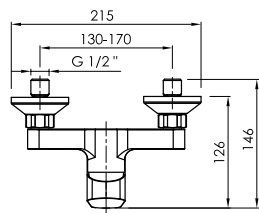

mm



Monomando
Mixer
Mitigeur



Teleducha 3 funciones
3 function hand shower
Douchette à main 3 fonction



Teleducha de ABS
ABS hand shower
Douchette à main en ABS



Caudal a 3 BAR
Flow rate at 3 BAR
Débit à 3 BAR



Flexo 1,5m acero inoxidable
1,5 m stainless steel hose
Flexible 1,5m acier inoxydable

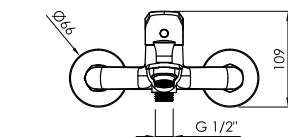
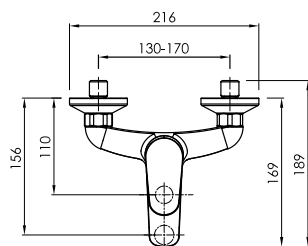

mm



Monomando
Mixer
Mitigeur



Aireador NEOPERL®
NEOPERL® aerator
Aérateur NEOPERL®



Teleducha 3 funciones
3 function hand shower
Douchette à main 3 fonction



Teleducha de ABS
ABS hand shower
Douchette à main en ABS



Caudal a 3 BAR
Flow rate at 3 BAR
Débit à 3 BAR



Caudal a 3 BAR
Flow rate at 3 BAR
Débit à 3 BAR



Flexo 1,5m acero inoxidable
1,5m stainless steel hose
Flexible 1,5m acier inoxydable

Monomando exterior para ducha / Exposed shower mixer / Mitigeur de douche exterieur

con kit teleducha
with hand shower kit
avec kit douchette

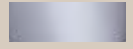
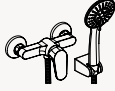

CR

MDU004CRK

124 €

Monomando exterior para baño-ducha / Exposed bath-shower mixer / Mitigeur de bain-douche exterieur

con kit teleducha
with hand shower kit
avec kit douchette

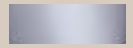
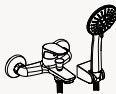

CR

MDB004CRK

152 €



Accessories

Accesorios

Accessoires

Accessories



Desagüe universal lavabo click-clack
o siempre abierto latón

Universal basin waste pop-up or
always open brass

Bonde lavabo universelle click-clack
ou toujours ouvert laiton

p. 209



Desagüe universal lavabo click-clack

Universal basin waste pop-up

Bonde lavabo universelle click-clack
ou toujours ouvert laiton

p. 209



Sifón botella tubular metálico

Metallic bottle trap tube

Siphon métallique round

p. 209



Sifón botella cuadrado inox

Bottle trap square stainless steel

Siphon métallique carrée

p. 209



Sifón flexible PP

PP flexible siphon

Siphon flexible PP

p. 209



Loop llave de paso lavabo 3/8"
cromo

Loop basin angle valve 3/8" chrome

Loop robinet d'arrêt sous lavabo 3/8"

p. 211



Cubo llave de paso lavabo 3/8"
cromo

Cubo basin angle valve 3/8" chrome

Cubo robinet d'arrêt sous lavabo
3/8"

p. 211



Barra de ducha deslizable ajustable redonda 30-65cm metálica

Metal adjustable round sliding shower bar 30-65cm

Barre de douche métallique ronde et coulissante et réglable 30-65cm

p. 213



Barra ducha deslizable ajustable cuadrada 30-65cm metálica

Metal adjustable square sliding shower bar 30-65cm

Barre de douche métallique carrée et coulissante et réglable 30-65cm

p. 213



Conjunto barra ducha deslizable redonda teleducha 3 funciones

Round sliding shower bar set with 3 function hand shower

Kit de barre de douche ronde coulissante avec 3 fonctions douchette

p. 215



Conjunto barra ducha deslizable cuadrada teleducha 3 funciones

Square sliding shower bar set with 3 function hand

Kit de barre de douche carrée coulissante avec 3 fonctions douchette

p. 215



Teleducha ABS 3 funciones

3 function hand shower

3 fonctions douchette

p. 217



Flexo de ducha PVC

PVC flexible hose

Flexible de douche PVC

p. 217



Flexo de ducha acero inoxidable

Stainless steel flexible hose

Flexible de douche acier inoxydable

p. 217

Accessories

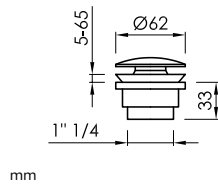

Click-clack
Pop-up
Click-clack



Opcion: siempre abierto
Option: always open
Option: sempre ouvert



Latón
Brass
Laiton

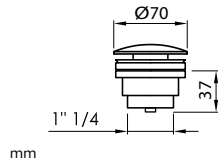

Click-clack
Pop-up
Click-clack



Latón
Brass
Laiton

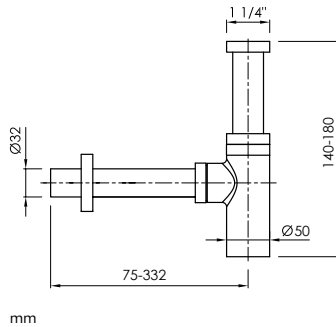

Metal
Metal
Metallique

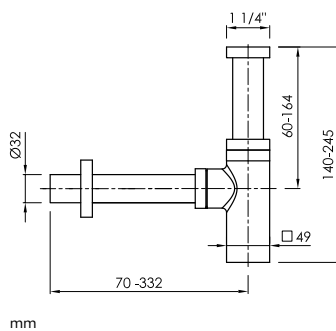

Latón
Brass
Laiton

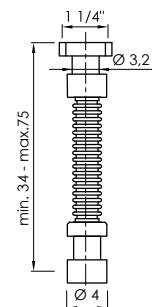

PP
PP
PP

Desagüe universal lavabo / Universal basin pop-up waste / Bonde lavabo universelle click-clack



click-clack o siempre abierto
pop-up or always open
click-clack ou sempre ouvert

	CR	BM	MG	NB	BG	RG
ACCLV005CR	ACCLV005BM	ACCLV005MG	ACCLV005NB	ACCLV005BG	ACCLV005RG	
65 €	70 €	77 €	77 €	77 €	77 €	



click-clack
pop-up
click-clack

ACCLV001
31 €

Sifón botella tubular metálico / Metallic bottle trap tube / Siphon métallique round

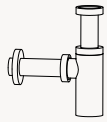

	CR	BM	MG	NB	BG	RG
ACCLV002	ACCLV002NM	ACCLV002MG	ACCLV002NB	ACCLV002BG	ACCLV002RG	
50 €	55 €	130 €	130 €	130 €	130 €	

Sifón botella cuadrado metálico / Metallic bottle trap square / Siphon métallique carrée

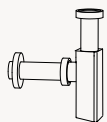

	CR	BM
ACCLV006CR	ACCLV006BM	
75 €	123 €	

Sifón flexible PP / PP flexible siphon / Siphon flexible PP

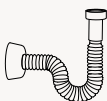

	CR
ACCLV003	
20 €	

Accessories

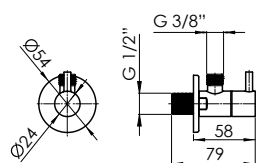

Latón
Brass
Laiton

mm

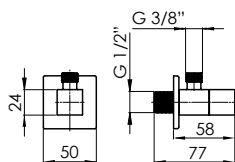

Latón
Brass
Laiton

mm

Loop llave de paso lavabo 3/8" / Loop basin angle valve 3/8" / Loop robinet d'arrê sous lavabo 3/8"

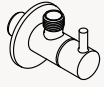

					
CR	BM	MG	NB	BG	RG
TOL001CR	TOL001BM	TOL001MG	TOL001NB	TOL001BG	TOL001RG
45 €	50 €	55 €	55 €	55 €	55 €

Cubo llave de paso lavabo 3/8" / Cubo basin angle valve 3/8" / Cubo robinet d'arrê sous lavabo 3/8"

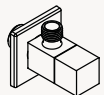

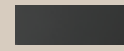
	
CR	BM
TOL002CR	TOL002BM
50 €	55 €

Accessories

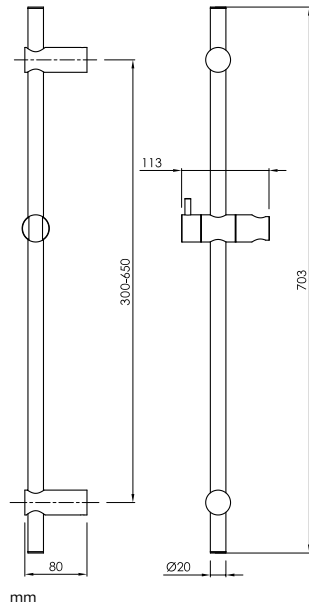

Agujeros instalación a pared
ajustables
Adjustable wall fixing holes
Trous d'installation muraux
ajustables



Barra deslizante metálica
Metal sliding shower bar
Barre de douche métallique



Soporte deslizante y orientable
Sliding and adjustable support
Support coulissant et pivotant

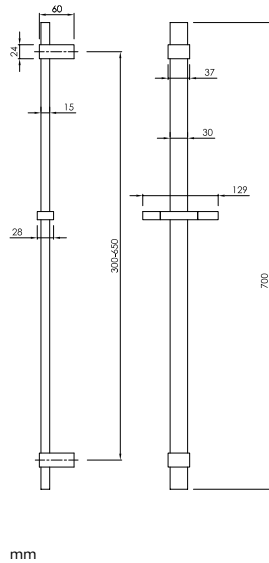

Agujeros instalación a pared
ajustables
Adjustable wall fixing holes
Trous d'installation muraux
ajustables



Barra deslizante metálica
Metal sliding shower bar
Barre de douche métallique



Soporte deslizante y orientable
Sliding and adjustable support
Support coulissant et pivotant

Barra ducha deslizante ajustable redonda 30-65cm / Adjustable round sliding shower bar 30-65cm / Barre de douche ronde et coulissante et réglable 30-65cm

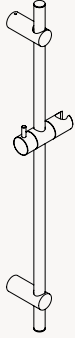

CR

BAR04170CR

96 €

Barra ducha deslizante ajustable cuadrada 30-65cm / Adjustable square sliding shower bar 30-65cm / Barre de douche carrée et coulissante et réglable 30-65cm

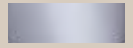
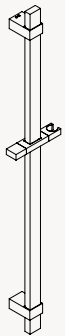

CR

BAR04280CR

129 €

Accessories

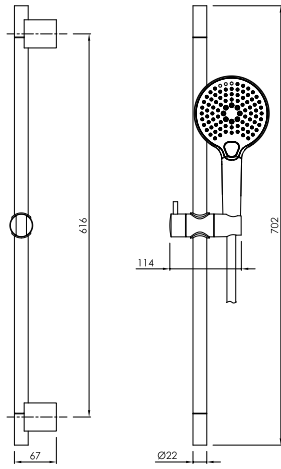

mm



Soporte deslizante y orientable
Sliding and adjustable support
Support coulissant et pivotant



Teleducha de ABS
ABS hand shower
Douchette à main en ABS



Teleducha 3 funciones
3 function hand shower
Douchette à main 3 fonctions



Flexo inox 1,5m
1,5 m inox hose
Flexible inox 1,5m



Caudal a 3 BAR
Flow rate at 3 BAR
Débit à 3 BAR



Caudal a 3 BAR
Flow rate at 3 BAR
Débit à 3 BAR



Caudal a 3 BAR
Flow rate at 3 BAR
Débit à 3 BAR



Barra deslizante metálica
Metal sliding shower bar
Barre de douche métallique

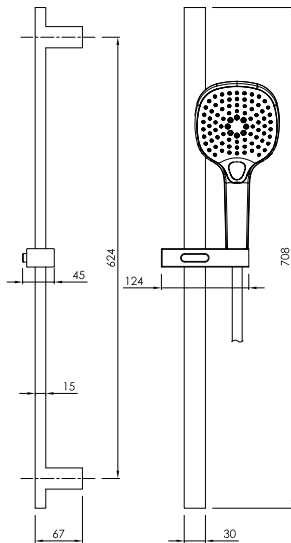

mm



Soporte deslizante y orientable
Sliding and adjustable support
Support coulissant et pivotant



Teleducha de ABS
ABS hand shower
Douchette à main en ABS



Teleducha 3 funciones
3 function hand shower
Douchette à main 3 fonctions



Flexo inox de 1,5m
1,5 m inox hose
Flexible inox 1,5m



Caudal a 3 BAR
Flow rate at 3 BAR
Débit à 3 BAR



Caudal a 3 BAR
Flow rate at 3 BAR
Débit à 3 BAR



Caudal a 3 BAR
Flow rate at 3 BAR
Débit à 3 BAR



Barra deslizante metálica
Metal sliding shower bar
Barre de douche métallique

Conjunto barra ducha deslizante redonda / Adjustable round shower bar set/ Kit de barre de douche ronde coulissante

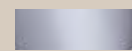
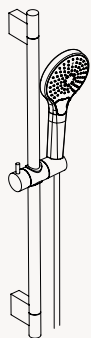

CR

BAR043CRK

85 €

Conjunto barra ducha deslizante cuadrada / Square sliding shower bar set / Kit de barre de douche carrée coulissante

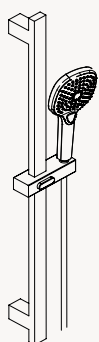

CR

BAR044CRK

97 €

Accessories

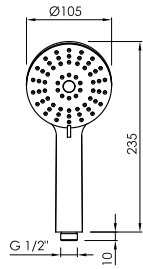

mm



Teleducha de ABS
ABS hand shower
Douchette à main en ABS



Teleducha 3 funciones
3 function hand shower
Douchette à main 3 fonctions



Caudal a 3 BAR
Flow rate at 3 BAR
Débit à 3 BAR



Caudal a 3 BAR
Flow rate at 3 BAR
Débit à 3 BAR



Caudal a 3 BAR
Flow rate at 3 BAR
Débit à 3 BAR



Flexo de PVC
PVC hose
Flexible PVC



1,5 m
1,5 m
1,5 m



Sistema anti-torsión
Anti-twist
Système anti-torsion



Flexo acero inoxidable
Stainless steel hose
Flexible acier inoxydable



1,5 m
1,5 m
1,5 m



Sistema anti-torsión
Anti-twist
Système anti-torsion

Teleducha ABS 3 funciones / 3 function ABS hand shower / 3 fonctions ABS douchette



CR

TEL004CR

32 €

Flexo de ducha PVC / PVC Flexible hose / Flexible de douche PVC

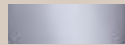

CR

FLE010CR

32 €

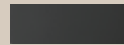

BM

FLE010BM

35 €



MG

FLE010MG

42 €



NB

FLE010NB

42 €

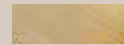

BG

FLE010BG

42 €



RG

FLE010RG

42 €

Flexo de ducha acero inoxidable / Stainless steel flexible hose / Flexible de douche acier inoxydable

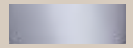

CR

FLE000CR

30 €



Kitchen faucets

Griferías de cocina

Robinetterie de cuisine

Spray

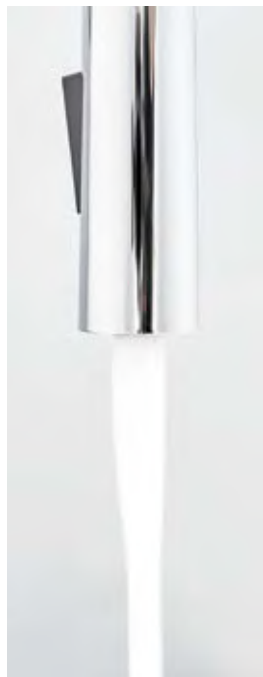

GCO041CR
Chrome



Curve





GCO042CR
Chrome

Spray

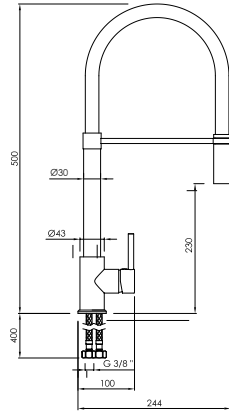

1

mm



Apertura en frío
Cold open
Ouverture en eau froide



Ahorro de energía
Energy saving
Économie d'énergie



Giratorio 360°
Swivel 360°
Rotatoire à 360°



Manguera flexible
Flexible hose
Tuyaux flexible



Cartucho SEDAL®
SEDAL® cartridge
Cartouche SEDAL®



Caudal a 3 BAR
Flow rate at 3 BAR
Débit à 3 BAR



Caudal a 3 BAR
Flow rate at 3 BAR
Débit à 3 BAR



2 Funciones
2 Functions
2 Fonctions



Extraíble
Removable
Extraible

Curve

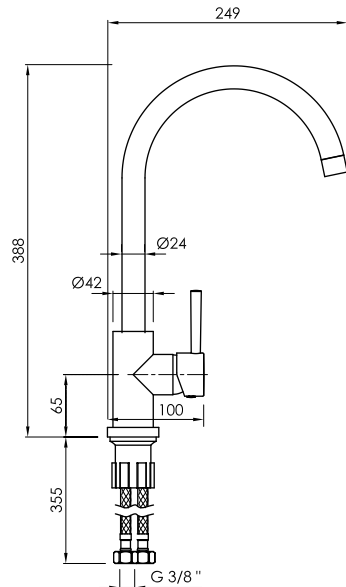

mm



Apertura en frío
Cold open
Ouverture en eau froide



Ahorro de energía
Energy saving
Économie d'énergie



Cartucho SEDAL®
SEDAL® cartridge
Cartouche SEDAL®



Caudal a 3 BAR
Flow rate at 3 BAR
Débit à 3 BAR



Giratorio 360°
Swivel 360°
Rotatoire à 360°

Monomando cocina flexo extraíble / Kitchen mixer removable hose / Mitigeur de cuisine tuyau amovible



CR

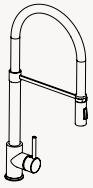

GCO041CR

315 €

Monomando cocina / Kitchen mixer / Mitigeur de cuisine

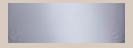

CR

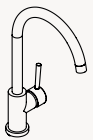

GCO042CR

198 €

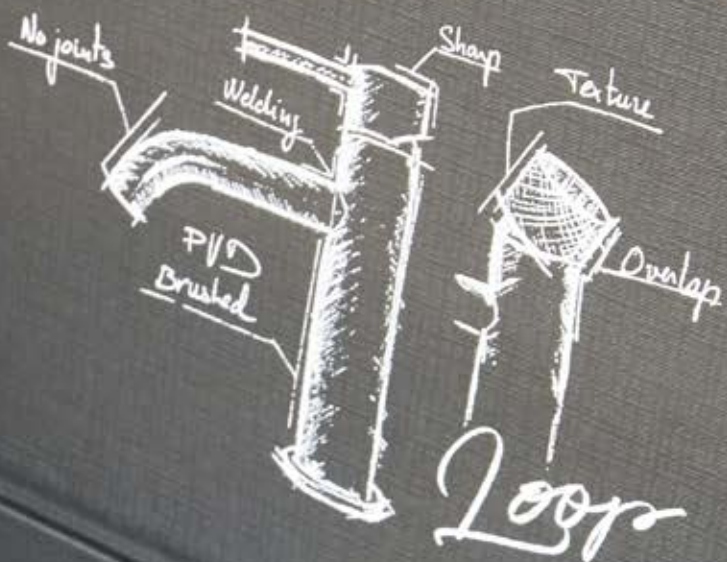

sanycces

sanycces

sanycces

sanycces

sanycces

sanycces

sanycces

sanycces

Showroom displays

Útiles para exposición

Outils de presentation

Displays



Peana para grifería pequeña
Small base for taps
Petit socle pour robinet
p. 231



Peana para grifería grande
Big base for taps
Grand socle pour robinet
p 231



Peana para grifería extra grande
Extra big base for taps
Extragrand socle pour robinet
p 231



Caja muestrario de grifería Loop
Sample box of taps Loop
Boîte d'échantillons de robinets Loop
p. 231



Muestrario de acabados
Color swatch set
Échantillons de finitions
p. 231



Panel expositor griferías imagen
Image faucets display panel
Panneau d'affichage des robinets
avec image
p. 233



Panel expositor griferías murales
Display panel for wall-mounted
faucets
Panneau d'affichage pour robinets
mural
p. 233



Panel expositor griferías de repisa
Display panel for counter faucets
Panneau d'affichage étagère pour
robinets
p. 233



Panel expositor griferías murales
Display panel for wall-mounted
faucets
Panneau d'affichage pour robinets
mural
p. 233



Panel expositor griferías murales
Display panel for wall-mounted
faucets
Panneau d'affichage pour robinets
mural
p. 233



Aparador expositor de griferías con
trasera
Faucets display cabinet with
backpanel
Vitrine pour robinets avec panneau
arrière
p. 235



Aparador expositor de griferías
sin trasera
Faucets display cabinet without
backpanel
Vitrine pour robinets sans
panneau arrière
p. 235

Displays



Peana para grifería pequeña / Small base for taps / Petit socle pour robinet



LOOP	CUBO	AIR	PROJECT
EXGRS001	EXGRS002	EXGRS003	EXGRS004
60 €*	60 €*	60 €*	60 €*

Peana para grifería grande / Big base for taps / Grand socle pour robinet

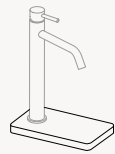

LOOP	CUBO	AIR	SPRAY	CURVE
EXGRL001	EXGRL002	EXGRL003	EXGRLGCO	EXGRLGCO
65 €*	65 €*	65 €*	65 €*	65 €*

Peana para grifería extra grande / Extra big base for taps / Extragrand socle pour robinet

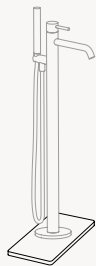

LOOP	LOOP	CUBO	CUBO	AIR
EXGRXL000	EXGRXL000	EXGRXL000	EXGRXL000	EXGRXL000
-	-	-	-	-

Loop caja muestrario / Loop sample box / Boîte d'échantillons de robinets Loop



CR	BM	MG	NB	BG	RG
EXPLOOPBOXCR	EXPLOOPBOXBM	EXPLOOPBOXMG	EXPLOOPBOXNB	EXPLOOPBOXBG	EXPLOOPBOXRG
360 €	360 €	360 €	360 €	360 €	360 €

Muestrario de acabados / Color swatch set / Échantillons de finitions



MUGR001

50 €

* Esta referencia solo incluye la base soporte, se debe adjuntar referencia de la grifería en el pedido.

* This reference only includes the support base, you must attach the faucet reference in the order.

* Cette référence ne comprend que la base de support, la référence de la robinetterie doit être incluse dans la commande.

Displays

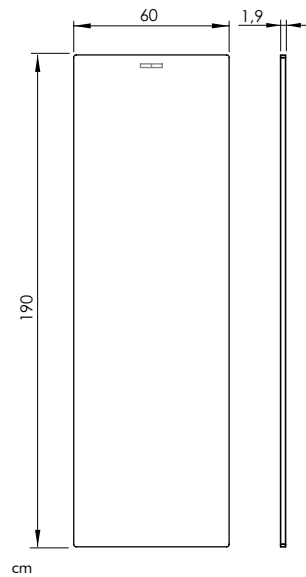
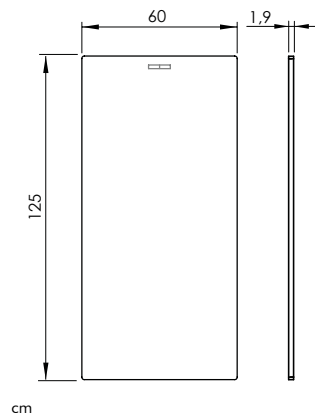
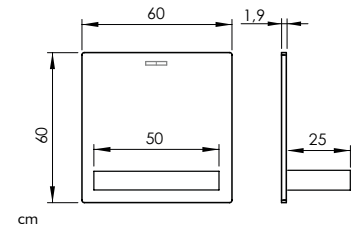
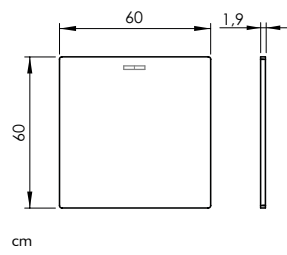
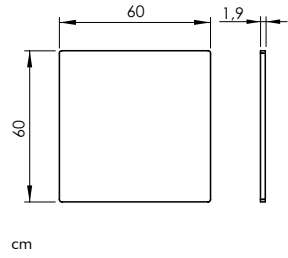

Panel expositor griferías imagen / Image faucets display panel / Panneau d'affichage des robinets avec image



				
MUGR101	MUGR102	MUGR103	MUGR104	MUGR105
150 €	150 €	150 €	150 €	150 €

Panel expositor griferías murales / Display panel for wall-mounted faucets / Panneau d'affichage pour robinets mural

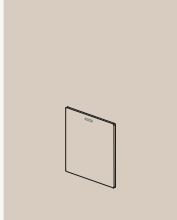
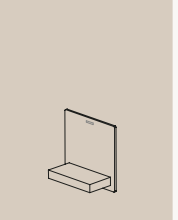
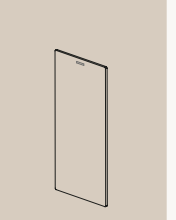
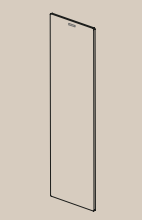
			
MUGR200	MUGR300	MUGR400	MUGR500
150 €*	150 €*	150 €*	150 €*

* Esta referencia solo incluye el expositor, se debe adjuntar referencia de la grifería en el pedido.

* This reference only includes the display panel, you must attach the faucet reference in the order.

* Cette référence ne comprend que le panneau d'affichage, la référence de la robinetterie doit être incluse dans la commande.

Displays



Aparador expositor de griferías con trasera / Faucets display cabinet with backpanel / Vitrine pour robinets avec panneau arrière

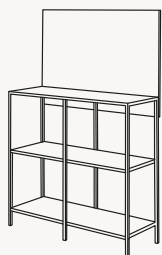

100x36x153 cm

MUGR600

400 €*

Aparador expositor de griferías sin trasera / Faucets display cabinet without backpanel / Vitrine pour robinets sans panneau arrière



100x36x93 cm

MUGR601

300 €*

* Esta referencia solo incluye la base soporte, se debe adjuntar referencia de la grifería en el pedido.

* This reference only includes the support base, you must attach the faucet reference in the order.

* Cette référence ne comprend que la base de support, la référence de la robinetterie doit être incluse dans la commande.













Spare parts















Recambios

Pièces de rechange











Spare parts

LOOP		LOOP K		 Cartucho monomando Mixer cartridge Mitigeur cartouche	 Cartucho desviador o llave de paso Diverter cartridge or flow cartridge Cartouche de dérivation ou vanne d'arrêt	 Cartucho termostático Thermostatic cartridge Cartouche thermostatique	 Aireador Aerator Mousseur
	MNO001CR		MNO011CR..				
	MNO001BM		MNO011BM..				
	MNO001MG		MNO011MG..	RECGR0129 30 €			RECGR0472 20 €
	MNO001NB		MNO011NB..				
	MNO001BG		MNO011BG..				
	MNO001RG		MNO011RG..				
<hr/>							
	MOA001CR		MOA011CR..				
	MOA001BM		MOA011BM..				
	MOA001MG		MOA011MG..	RECGR0129 30 €			RECGR0472 20 €
	MOA001NB		MOA011NB..				
	MOA001BG		MOA011BG..				
	MOA001RG		MOA011RG..				
<hr/>							
	MBD001CR		MBD011CR..				RECGR0449 20 €
	MBD001BM		MBD011BM..				RECGR0450 25 €
	MBD001MG		MBD011MG..	RECGR0129 30 €			RECGR0451 25 €
	MBD001NB		MBD011NB..				RECGR0452 25 €
	MBD001BG		MBD011BG..				RECGR0453 25 €
	MBD001RG		MBD011RG..				RECGR0454 25 €

LOOP		LOOP K		 Cartucho monomando Mixer cartridge Mitigeur cartouche RECGR0236 30 €		 Cartucho desviador o llave de paso Diverter cartridge or flow cartridge Cartouche de dérivation ou vanne d'arrêt		 Cartucho termostático Thermostatic cartridge Cartouche thermostatique		 Aireador Aerator Mousseur	
	MEN000		MEN000								
	MEN001R18CR		MEN011R18CR--								
	MEN001R18BM		MEN011R18BM--								
	MEN001R18MG		MEN011R18MG--	RECGR0236						RECGR0472	
	MEN001R18NB		MEN011R18NB--	30 €						20 €	
	MEN001R18BG		MEN011R18BG--								
	MEN001R18RG		MEN011R18RG--								
	MEN001R14CR		MEN011R14CR--								
	MEN001R14BM		MEN011R14BM--								
	MEN001R14MG		MEN011R14MG--	RECGR0236						RECGR0472	
	MEN001R14NB		MEN011R14NB--	30 €						20 €	
	MEN001R14BG		MEN011R14BG--								
	MEN001R14RG		MEN011R14RG--								
	MEN001S18CR		MEN011S18CR--								
	MEN001S18BM		MEN011S18BM--								
	MEN001S18MG		MEN011S18MG--	RECGR0236						RECGR0472	
	MEN001S18NB		MEN011S18NB--	30 €						20 €	
	MEN001S18BG		MEN011S18BG--								
	MEN001S18SG		MEN011S18SG--								
	MEN001S14CR		MEN011S14CR--								
	MEN001S14BM		MEN011S14BM--								
	MEN001S14MG		MEN011S14MG--	RECGR0236						RECGR0472	
	MEN001S14NB		MEN011S14NB--	30 €						20 €	
	MEN001S14BG		MEN011S14BG--								
	MEN001S14SG		MEN011S14SG--								

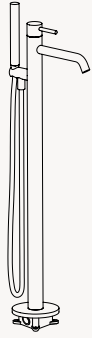
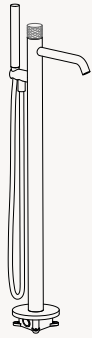
Spare parts

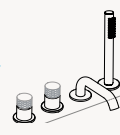
LOOP		LOOP K		 Cartucho monomando Mixer cartridge Mitigeur cartouche		 Cartucho desviador o llave de paso Diverter cartridge or flow cartridge Cartouche de dérivation ou vanne d'arrêt		 Cartucho termostático Thermostatic cartridge Cartouche thermostatique		 Aireador Aerator Mousseur	
	MEX001CR		MEX011CR..								
	MEX001BM		MEX011BM..								
	MEX001MG		MEX011MG..	RECGR0129						RECGR0472	
	MEX001NB		MEX011NB..	30 €						20 €	
	MEX001BG		MEX011BG..								
	MEX001RG		MEX011RG..								
	BNACC204		BNEX011CR..								
	BNACC205		BNEX011BM..								
	BNEX001MG		BNEX011MG..	RECGR0053						RECGR0605	
	BNEX001NB		BNEX011NB..	75 €						20 €	
	BNEX001BG		BNEX011BG..								
	BNEX001RG		BNEX011RG..								
	BNBB001CR		BNBB011CR..								
	BNBB001BM		BNBB011BM..								
	BNBB001MG		BNBB011MG..	RECGR0597	RECGR0571					RECGR0584	
	BNBB001NB		BNBB011NB..	30 €	25 €					20 €	
	BNBB001BG		BNBB011BG..								
	BNBB001RG		BNBB011RG..								

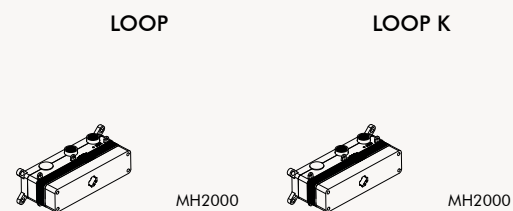

RECGR0055
30 €

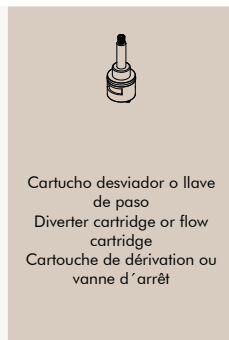

RECGR0571
25 €

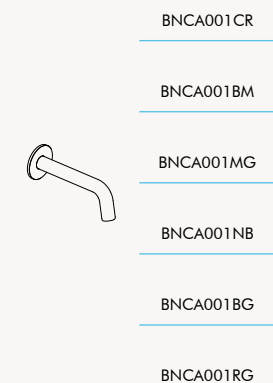
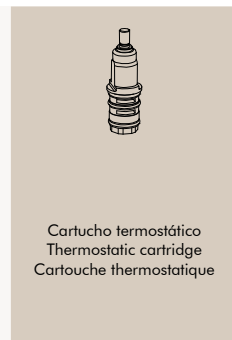

RECGR0140
20 €

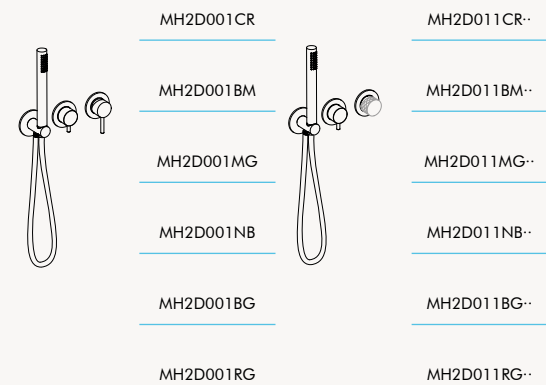





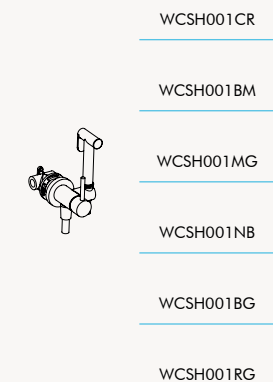

RECGR0055
30 €





RECGR0571
25 €

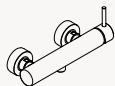
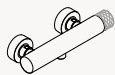
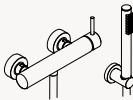
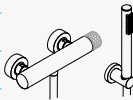
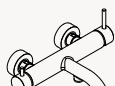
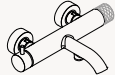
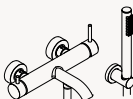

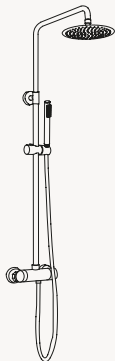
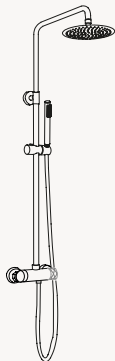





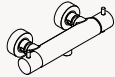
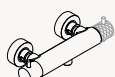
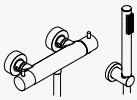
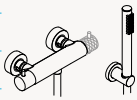
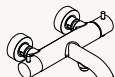
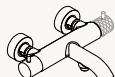
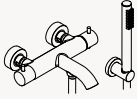
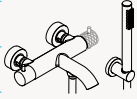
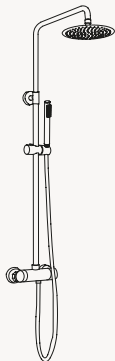
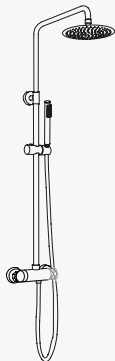





RECGR0505
30 €

Spare parts

LOOP		LOOP K		 Cartucho monomando Mixer cartridge Mitigeur cartouche		 Cartucho desviador o llave de paso Diverter cartridge or flow cartridge Cartouche de dérivation ou vanne d'arrêt		 Cartucho termostático Thermostatic cartridge Cartouche thermostatique		 Aireador Aerator Mousseur	
	MDU001CR		MDU011CR-	RECGR0055	30 €						
	MDU001BM		MDU011BM-								
	MDU001MG		MDU011MG-								
	MDU001NB		MDU011NB-								
	MDU001BG		MDU011BG-								
	MDU001RG		MDU011RG-								
	MDU001CRK		MDU011CR-K	RECGR0055	30 €						
	MDU001BMK		MDU011BM-K								
	MDU001MGK		MDU011MG-K								
	MDU001NBK		MDU011NB-K								
	MDU001BGK		MDU011BG-K								
	MDU001RGK		MDU011RG-K								
	MDB001CR		MDB011CR-	RECGR0055	30 €		RECGR0058	25 €		RECGR0346	25 €
	MDB001BM		MDB011BM-								
	MDB001MG		MDB011MG-								
	MDB001NB		MDB011NB-								
	MDB001BG		MDB011BG-								
	MDB001RG		MDB011RG-								
	MDB001CRK		MDB011CR-K	RECGR0055	30 €		RECGR0058	25 €		RECGR0346	25 €
	MDB001BMK		MDB011BM-K								
	MDB001MGK		MDB011MG-K								
	MDB001NBK		MDB011NB-K								
	MDB001BGK		MDB011BG-K								
	MDB001RGK		MDB011RG-K								
	COMET722		COMO011CR-	RECGR0055	30 €		RECGR0058	25 €			
	COMO001BM		COMO011BM-								
	COMO001MG		COMO011MG-								
	COMO001NB		COMO011NB-								
	COMO001BG		COMO011BG-								
	COMO001RG		COMO011RG-								

LOOP		LOOP K		 Cartucho monomando Mixer cartridge Mitigeur cartouche	 Cartucho desviador o llave de paso Diverter cartridge or flow cartridge Cartouche de dérivation ou vanne d'arrêt	 Cartucho termostático Thermostatic cartridge Cartouche thermostatique	 Aireador Aérateur Mousseur
	TDU001CR		TDU011CR..				
	TDU001BM		TDU011BM..				
	TDU001MG		TDU011MG..		RECGR0180	RECGR0494	
	TDU001NB		TDU011NB..		25 €	100 €	
	TDU001BG		TDU011BG..				
	TDU001RG		TDU011RG..				
	TDU001BMK		TDU011BM..K				
	TDU001CRK		TDU011CR..K				
	TDU001MGK		TDU011MG..K		RECGR0180	RECGR0494	
	TDU001NBK		TDU011NB..K		25 €	100 €	
	TDU001BGK		TDU011BG..K				
	TDU001RGK		TDU011RG..K				
	TDB001CR		TDB011CR..				RECGR0370 20 €
	TDB001BM		TDB011BM..				RECGR0371 20 €
	TDB001MG		TDB011MG..		RECGR0174	RECGR0182	RECGR0372 20 €
	TDB001NB		TDB011NB..		25 €	100 €	RECGR0373 20 €
	TDB001BG		TDB011BG..				RECGR0374 20 €
	TDB001RG		TDB011RG..				RECGR0375 20 €
	TDB001CRK		TDB011CR..K				RECGR0370 20 €
	TDB001BMK		TDB011BM..K				RECGR0371 20 €
	TDB001MGK		TDB011MG..K		RECGR0174	RECGR0182	RECGR0372 20 €
	TDB001NBK		TDB011NB..K		25 €	100 €	RECGR0373 20 €
	TDB001BGK		TDB011BG..K				RECGR0374 20 €
	TDB001RGK		TDB011RG..K				RECGR0375 20 €
	COMET724		COTE011CR..				
	COMET725		COTE011BM..				
	COTE001MG		COTE011MG..		RECGR0626	RECGR0182	
	COTE001NB		COTE011NB..		25 €	100 €	
	COTE001BG		COTE011BG..				
	COTE001RG		COTE011RG..				

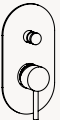
Spare parts

LOOP		LOOP K		 Cartucho monomando Mixer cartridge Mitigeur cartouche		 Cartucho desviador o llave de paso Diverter cartridge or flow cartridge Cartouche de dérivation ou vanne d'arrêt		 Cartucho termostático Thermostatic cartridge Cartouche thermostatique		 Aireador Aerator Mousseur	
	ME1000		ME1000	RECGR0242	30 €						
	ME1001CR		ME1011CR-								
	ME1001BM		ME1011BM-								
	ME1001MG		ME1011MG-	RECGR0242	30 €						
	ME1001NB		ME1011NB-								
	ME1001BG		ME1011BG-								
	ME1001RG		ME1011RG-								
	ME2000		ME2000	RECGR0242	30 €						
	ME2001CR		ME2011CR-			RECGR0246	60 €				
	ME2001BM		ME2011BM-			RECGR0247	60 €				
	ME2001MG		ME2011MG-	RECGR0242	30 €	RECGR0268	60 €				
	ME2001NB		ME2011NB-			RECGR0269	60 €				
	ME2001BG		ME2011BG-			RECGR0270	60 €				
	ME2001RG		ME2011RG-			RECGR0271	60 €				

LOOP

LOOP K

Cartucho monomando
Mixer cartridge
Mitigeur cartouche

Cartucho desviador o llave de paso
Diverter cartridge or flow cartridge
Cartouche de dérivation ou vanne d'arrêt

Cartucho termostático
Thermostatic cartridge
Cartouche thermostatique

Aireador
Aerator
Mousseur



TE1000

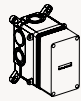

TE1000

RECGR0250
35 €

RECGR0251
100 €



TE3000



TE3000

RECGR0250
35 €

RECGR0251
100 €

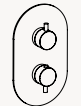

T13001MG

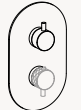

T13011MG

RECGR0250
35 €

RECGR0251
100 €

T13001NB

T13011NB

T13001BG









T13011BG

T13001RG

T13011RG

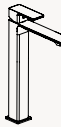
Spare parts

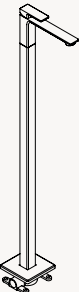
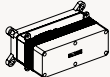
Spare parts

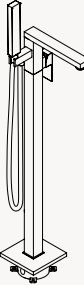
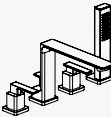
CUBO		 Cartucho monomando Mixer cartridge Mitigeur cartouche	 Cartucho desviador o llave de paso Diverter cartridge or flow cartridge Cartouche de dérivation ou vanne d'arrêt	 Cartucho termostático Thermostatic cartridge Cartouche thermostatique	 Aireador Aerator Mo
	MNO002CR	RECGR0129			RECGR0132
	MNO002BM	30 €			20 €
	MOA002CR	RECGR0129			RECGR0132
	MOA002BM	30 €			20 €
	MBD002CR	RECGR0129			RECGR0138
	MBD002BM	30 €			25 € RECGR0139 27 €
	MEX002CR	RECGR0060			RECGR0132
	MEX002CR	30 €			20 €
	MEN000	RECGR0236			
		30 €			
	MEN002CR	RECGR0236			RECGR0132
	MEN002BM	30 €			20 €
	BNEX002CR	RECGR0157	RECGR0061		RECGR0156
	BNEX002BM	30 €	25 €		20 €
	BNBB002CR		RECGR0147 (LEFT)		RECGR0163
	BNBB002BM		30 €		20 €
			RECGR0142 (RIGHT)		RECGR0114
			30 €		20 €

CUBO



Cartucho monomando
Mixer cartridge
Mitigeur cartouche



Cartucho desviador o llave
de paso
Diverter cartridge or flow
cartridge
Cartouche de dérivation ou
vanne d'arrêt



Cartucho termostático
Thermostatic cartridge
Cartouche thermostatique



Aireador
Aerator
Mo

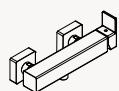

MDU002CR

RECGR0055

30 €

MDU002BM

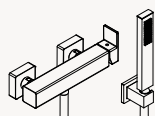

MDU002CRK

RECGR0055

30 €

MDU002BMK

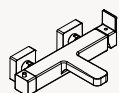

MDB002CR

RECGR0055

30 €

RECGR0054

25 €

RECGR0176

20 €

MDB002BM

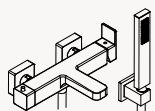

MDB002CRK

RECGR0055

30 €

RECGR0054

25 €

RECGR0176

20 €

MDB002BMK

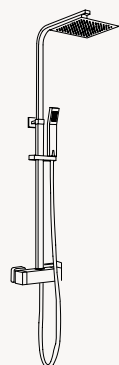

COMET721

RECGR0055

30 €

RECGR0054

25 €

COMO002BM



Spare parts

Spare parts

CUBO



Cartucho monomando
Mixer cartridge
Mitigeur cartouche



Cartucho desviador o llave
de paso
Diverter cartridge or flow
cartridge
Cartouche de dérivation ou
vanne d'arrêt



Cartucho termostático
Thermostatic cartridge
Cartouche thermostatique



Aireador
Aerator
Mo

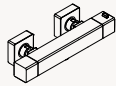

TDU002CR

RECGR0180

RECGR0494

25 €

100 €

TDU002BM

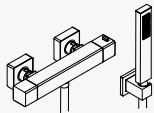

TDU002CRK

RECGR0180

RECGR0494

25 €

100 €

TDU002BMK

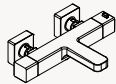

TDB002CR

RECGR0174

RECGR0057

25 €

100 €

RECGR0370
20 €

TDB002BM

RECGR0371
20 €

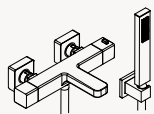

TDB002CRK

RECGR0174

RECGR0057

25 €

100 €

RECGR0370
20 €

TDB002BMK

RECGR0371
20 €

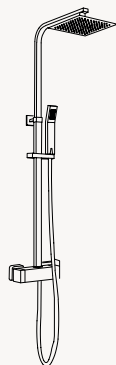

COMET723

RECGR0056

RECGR0057

25 €

100 €

COTE002BM

CUBO



Cartucho monomando
Mixer cartridge
Mitigeur cartouche



Cartucho desviador o llave
de paso
Diverter cartridge or flow
cartridge
Cartouche de dérivation ou
vanne d'arrêt



Cartucho termostático
Thermostatic cartridge
Cartouche thermostatique



Aireador
Aerator
Mousseur



RECGR0242

30 €

ME1000



ME1002CR

RECGR0242

30 €

ME1002BM

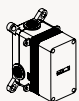

RECGR0242

30 €

ME2000

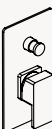

ME2002CR

RECGR0242

30 €

ME2002BM

RECGR0246

60 €

RECGR0247

60 €



TE1000

RECGR0250

35 €

RECGR0251

100 €



TE3000

RECGR0250

35 €

RECGR0251

100 €



T13002CR

RECGR0250

35 €

RECGR0251

100 €

T13002BM

Spare parts

AIR



Cartucho monomando
Mixer cartridge
Mitigeur cartouche



Cartucho desviador o llave
de paso
Diverter cartridge or flow
cartridge
Cartouche de dérivation ou
vanne d'arrêt



Cartucho termostático
Thermostatic cartridge
Cartouche thermostatique



Aireador
Aerator
Mousseur



MNO003CR

RECGR0102

RECGR0132

30 €

20 €

MNO003BM

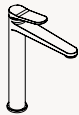

MOA003CR

RECGR0102

RECGR0132

30 €

20 €

MOA003BM



MBD003CR

RECGR0102

RECGR0138

30 €

25 €

MBD003BM

RECGR0139

25 €

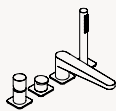

BNBB003CR

RECGR0117

RECGR0116

RECGR0114

30 €

27 €

20 €

BNBB003BM

PROJECT



Cartucho monomando
Mixer cartridge
Mitigeur cartouche



Cartucho desviador o llave
de paso
Diverter cartridge or flow
cartridge
Cartouche de dérivation ou
vanne d'arrêt



Cartucho termostático
Thermostatic cartridge
Cartouche thermostatique



Aireador
Aerator
Mousseur



MNO004CR

RECGR0207
30 €

RECGR0210
20 €



MBD004CR

RECGR0608
30 €

RECGR0607
20 €



MDU004CRK

RECGR0117
30 €



MDB004CRK

RECGR0117
30 €

RECGR0222
20 €

KITCHEN FAUCETS

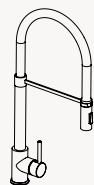

GCO041CR

RECGR0633
30 €

RECGR0461
50 €

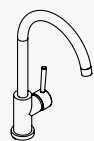

GCO042CR

RECGR0633
30 €

RECGR0456
20 €

Certificates

Certificados

Certificats



Certified for excellence

Certificados para la excelencia

Certifié pour l'excellence

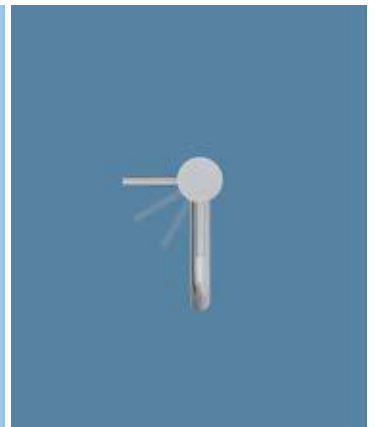
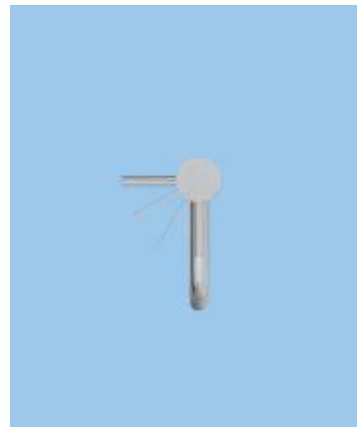
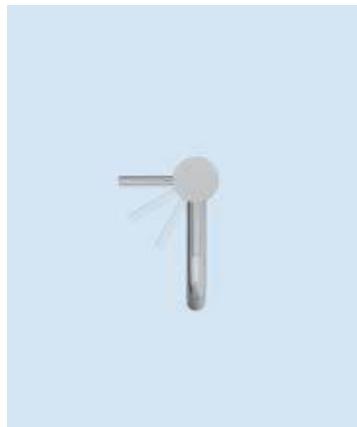



Además de los tests funcionales y de envejecimiento exigidos por las normativas aplicables, tomamos conciencia de la importancia de asegurar la salubridad del agua en contacto con la grifería así la preservación de las instalaciones de suministro de agua potable. Ponemos el foco en las certificaciones internacionales más estrictas en relación a estos aspectos como autoexigencia para garantizar la seguridad de nuestros productos en con el usuario y el entorno.



In addition to the functional and aging tests required by the applicable regulations, we are aware of the importance of ensuring the healthiness of the water in contact with the taps and the preservation of the drinking water supply facilities. We focus on the strictest international certifications in relation to these aspects as a self-demand to guarantee the safety of our products with the user and the environment.



Outre les tests de fonctionnement et de vieillissement exigés par la réglementation applicable, nous sommes conscients de l'importance de garantir la salubrité de l'eau en contact avec les robinets et la préservation des installations d'approvisionnement en eau potable. Nous nous concentrons sur les certifications internationales les plus strictes en ce qui concerne ces aspects, comme une exigence propre à garantir la sécurité de nos produits auprès de l'utilisateur et de l'environnement.





Warranty

Garantía

Garantie



CLÁUSULAS DE LA GARANTÍA

La presente garantía rige sin perjuicio de las disposiciones legales obligatorias que pudieran ser de aplicación.

Sanycces, S.L. garantiza al usuario que la grifería y accesorios vendidos a partir del 1 de septiembre de 2020 están libres de defectos de fabricación en el momento de la entrega, y que bajo instalación y uso privado adecuados cumplen con las especificaciones declaradas en la correspondiente ficha técnica de producto.

Cobertura:

- 5 años de garantía para los productos en caso de defectos de fabricación confirmado por Sanycces, S.L.

- 2 años de garantía para los componentes sometidos a desgaste en caso de defectos de fabricación confirmado por Sanycces, S.L. (cartuchos, válvulas de no retorno, filtros, latiguillos, etc.).

Durante el plazo de garantía, se eliminarán gratuitamente los vicios del producto, mediante reparación del producto y/o sustitución de las partes eventualmente dañadas y/o sustitución integral del producto mismo.

- En caso de cambio, el producto afectado se reemplazará por el mismo producto siempre y cuando éste no haya dejado de fabricarse en el momento del aviso del fallo. En su defecto Sanycces, S.L. suministrará un producto de prestaciones iguales o superiores.

- En el caso de reparación, cuando el producto por su tamaño y movilidad fuera susceptible de ser transportado por el usuario al taller del Servicio Oficial del Fabricante, éste, quedará liberado de la obligación de trasladar su Personal Técnico, al domicilio del usuario. El fabricante se reserva el derecho según la complejidad técnica que pueda presentar la reparación de un producto el poder reclamarlo para ser reparado en sus instalaciones.

Plazos:

Los periodos de garantía anteriores computan a partir de la fecha de compra que tendrá que ser justificada por el correspondiente documento fiscal (tique de compra o factura). Es imprescindible que el usuario informe del fallo en el plazo máximo de dos meses desde que se detecte.

CONDICIONES

La presente garantía cubrirá los productos instalados bajo las siguientes condiciones.

- 1) Las llaves de paso bajo el lavabo deben ir equipadas con filtro que debe que ser limpiado periódicamente.
- 2) No instalen el producto en presencia de presión del agua superior a los 5 bares (en este caso, utilicen un reductor de presión).
- 3) La temperatura del agua no debe que ser superior a los 70°C.
- 4) Purguen las tuberías antes de instalar el grifo.
- 5) No enlacen la conexión de tierra de una instalación eléctrica al flexo o latiguillo o a otra tubería hidráulica.
- 6) Cierren las llaves de paso en caso de ausencia prolongada por más de veinticuatro horas.
- 7) Para la instalación cumplan con las indicaciones proporcionadas en las instrucciones de montaje del producto.
- 8) Para la limpieza y mantenimiento del producto se han seguido las instrucciones suministradas en el manual de usuario del producto.

EXCLUSIONES DE LA GARANTÍA

Quedan excluidos de la Garantía los siguientes aspectos:

1. Productos cuya instalación, uso y mantenimiento no cumplan las condiciones del apartado anterior.
2. Los daños originados por averías producidas como consecuencia de: Fuerza mayor, fenómenos atmosféricos, geológicos, agentes químicos, dureza del agua, exceso de cal, humedad ambiental excesiva, etc.
3. Defectos, daños o fallos causados por el transportista, el instalador o cualquier otro tercero.
4. Los daños originados por un almacenaje sin resguardo de la intemperie.
5. Los daños o mal funcionamiento como resultado de modificaciones de cualquier índole o motivo.
6. La intervención de personal técnico no autorizado o no perteneciente al Servicio oficial del fabricante, aun cuando a intervención sea solo parcial. El fabricante no instala ninguno de los productos de su catálogo, si bien, para facilitar la labor de sus clientes a este respecto cuenta con una serie de colaboradores absolutamente independientes (denominados

únicamente a efectos prácticos S.A.T.) quienes por sus servicios facturan directamente al propio cliente (si este decide contratar con alguno de ellos a través del fabricante), siendo responsabilidad de los mismos los trabajos que realicen. Los gastos que devengue el S.A.T. serán únicamente abonados por el fabricante, cuando actué como SERVICIO POST VENTA, en caso de que el producto se encuentre en periodo de GARANTÍA, previa verificación y reconocimiento de defecto de fabricación, por el departamento técnico de esta mercantil, comunicado en forma y plazo, respondiendo el S.A.T. igualmente por sus servicios

7. Los daños producidos por trabajos de fontanería, albañilería, carpintería, etc. Que fuesen necesarios para proceder a la instalación del producto o aparato en el domicilio del usuario.
8. Las obras o gastos extras y transformaciones de las acometidas de agua, electricidad, gas desagües, etc. que fuesen necesarias para la instalación de los productos cubiertos por la Garantía.
9. Reposición de productos que pierden su funcionalidad con su uso, cartuchos, flexibles, filtros, latiguillos, arandelas de estanqueidad, etc.
10. Productos de exposición y similares.

Ninguna persona o entidad está autorizada a introducir modificación alguna (verbal o escrita) sobre esta garantía.

WARRANTY CLAUSES

This warranty shall prevail, without prejudice to any mandatory legislation that might apply.

Sanycces, S.L. guarantees that all taps and accessories sold from September 1st 2020 are free of factory defects on their supply, and that when they are duly fitted and used in private applications, they meet the declared specifications in the corresponding technical product data sheet.

Coverage:

- 5-year product warranty covering factory defects verified by Sanycces, S.L.
- 2-year warranty for components subjected to wear and tear in the event of factory defects verified by Sanycces, S.L. (cartridges, non-return valves, filters, connecting hoses etc.).

During the warranty's period of validity, defects in the products will be rectified free of charge by repairing the product and/or replacing possible damaged parts and/or replacing the whole product.

- If the product is to be replaced, it shall be exchanged for another of the same model unless it has been discontinued on notification of the defect. In such an event, Sanycces, S.L. shall supply a product of similar or superior characteristics.
- If the product is to be repaired, the manufacturer shall not be obliged to send a member of its technical staff to the customer's home when the product is small and easy enough to be taken by the latter to the manufacturer's official Technical Service. Depending on the technical complexity of the product's repair, the manufacturer reserves the right to demand that it is repaired in its own facilities.

Warranty periods:

The above warranty periods shall come into force as from the date of purchase. This must be accounted for by submitting a copy of the corresponding tax document (the sales receipt or invoice).

Notice of the defect must be provided by the customer within a maximum of two months of its detection.

TERMS & CONDITIONS

This warranty covers products fitted in accordance with the following conditions:

- 1) The stopcocks under the washbasin

must be fitted with a filter, and this must be periodically cleaned.

- 2) The product must not be fitted when there is water pressure of over 5 bars. (In such an event, a water pressure reducing valve must be fitted).

- 3) The temperature of the water supply must never be higher than 70°C.

- 4) The pipes must be bled prior to fitting the tap.

- 5) An earth wire must not be attached to the connecting hose or to any other water pipe.

- 6) If users are away for over 24 hours, the stopcock must be turned off.

- 7) To fit the tap properly, the product assembly instructions must be carefully followed.

- 8) To clean and care for the product, the instructions in the user manual must be followed.

WARRANTY EXCLUSIONS

The warranty does not cover:

1. Products whose installation, use or care do not fulfil the conditions shown above.

2. Damage due to acts of force majeure, atmospheric or geological phenomena, chemical agents, the hardness of the water, excess lime, excessive atmospheric humidity etc.

3. Defects, damage or faults caused by the carrier, tap fitter or any other third party.

4. Damage due to the product being stored outside without adequate protection.

5. Damage or malfunctioning due to modifications of any kind or for any reason.

6. The intervention of unauthorized technical staff or staff not attached to the manufacturer's official Technical Service, even if they are only partly involved. The manufacturer does not fit any of the products in its range. Nonetheless, to facilitate this process for customers, it does count on the assistance of a series of fully independent collaborators (only referred to as the Technical Service for practical purposes). If customers decide to hire their services through the manufacturer, the said collaborators shall invoice the customer directly and be liable for the work that they provide. The incurred costs of the said

Technical Service shall only be paid by the manufacturer when POST-SALES SERVICES are provided and the product is still under GUARANTEE, following confirmation and acknowledgement by the manufacturer's technical department of the manufacturing defect, duly notified within the proper period. In such cases, the Technical Service shall be answerable for the services it supplies.

7. Damage caused by any plumbing, building and carpentry work that is required in order to fit the product or device in the customer's home.

8. Any extra work or expenses or alterations to the water, electricity or gas networks and drains etc. that are needed to fit the products covered by the warranty.

9. The replacement of products that no longer work properly due to repeated use, such as cartridges, flexi hoses, filters, connecting hoses, sealing washers etc.

10. Products that were display products or similar.

No person or entity shall be authorized to make any (verbal or written) amendment to this warranty.

CLAUSES DE LA GARANTIE

Cette garantie régit sans préjudice des dispositions légales obligatoires pouvant s'avérer applicables.

Sanycces, S.L. garantit à l'utilisateur que la robinetterie et les accessoires vendus à partir du 1er septembre 2020 ne présentent pas de vices de fabrication au moment de la livraison et qu'ils satisfont aux spécifications déclarées sur la fiche technique de produit dans le cadre d'une installation et d'une utilisation adéquates.

Couverture :

- 5 ans de garantie pour les produits en cas de vices de fabrication confirmés par Sanycces, S.L.
- 2 ans de garantie pour les composants soumis à usure en cas de vices de fabrication confirmés par Sanycces, S.L. (cartouches, valves anti-retour, filtres, flexibles, etc.).

Pendant la durée de la garantie, les vices du produit seront éliminés gratuitement, au moyen de la réparation du produit et/ou du remplacement des parties éventuellement endommagées et/ou du remplacement intégral du produit en lui-même.

- En cas de remplacement, le produit concerné sera remplacé par le même produit à condition que celui-ci soit toujours fabriqué au moment de la communication de la défaillance. Dans le cas contraire, Sanycces, S.L. fournira un produit avec des prestations similaires ou supérieures.

- En cas de réparation, si le produit, compte tenu de sa taille et sa mobilité, est susceptible d'être transporté par l'utilisateur à l'atelier du Service officiel du Fabricant, ce dernier sera déchargé de l'obligation de transférer son Personnel technique au domicile de l'utilisateur. Le fabricant se réserve le droit, selon la complexité technique que peut présenter la réparation d'un produit, de pouvoir le réclamer afin que celui-ci puisse être réparé au sein de ses installations.

Délais :

Les durées de garanties susmentionnées sont comptabilisées

à compter de la date d'achat qui devra être justifiée par le document fiscal correspondant (ticket ou facture d'achat).

Il est impératif que l'utilisateur communique la défaillance dans un délai maximal de deux mois à partir du moment où celle-ci est détectée.

CONDITIONS

La présente garantie couvrira les produits installés dans les conditions suivantes :

- 1) Les vannes d'arrêt sous le lavabo doivent être équipées d'un filtre qui doit être nettoyé régulièrement.
- 2) Le produit ne doit pas être installé en présence d'une pression d'eau supérieure à 5 bars (dans ce cas, utilisez un réducteur de pression).
- 3) La température de l'eau chaude ne doit pas dépasser les 70°C.
- 4) Purgez les tuyauteries avant d'installer le robinet.
- 5) Ne pas raccorder le câble de terre d'une installation électrique au flexible ni à une autre conduite d'eau.
- 6) Fermez les vannes d'arrêt en cas d'absence prolongée de plus de vingt-quatre heures.
- 7) Pour l'installation, veuillez respecter les indications fournies dans les instructions de montage du produit.
- 8) Pour le nettoyage et l'entretien du produit, veuillez suivre les instructions fournies dans le manuel d'utilisateur du produit.

EXCLUSIONS DE LA GARANTIE

La Garantie exclut les cas suivants :

1. Produits dont l'installation, l'utilisation et l'entretien ne respectent pas les conditions du point précédent.
2. Les dommages causés par des pannes produites suite à : des cas de force majeure, phénomènes atmosphériques, géologiques, agents chimiques, dureté de l'eau, excès de calcaire, humidité excessive de l'environnement, etc.
3. Défauts, dommages ou défaillances causés par le

transporteur, l'installateur ou tout autre tiers.

4. Les dommages causés par un entreposage exposé aux intempéries.

5. Les dommages ou le mauvais fonctionnement résultant de modifications, quel que soit leur nature ou motif.

6. L'intervention d'un personnel technique non agréé ou n'appartenant pas au Service officiel du fabricant, y compris en cas d'intervention partielle. Le fabricant n'installe aucun des produits de son catalogue, il dispose toutefois, pour faciliter la recherche de ses clients à cet égard, d'une liste de collaborateurs absolument indépendants (ci-après dénommés, à des fins pratiques uniquement, S.A.T.) qui facturent directement leurs services au client lui-même (si celui-ci décide d'engager les services de l'un d'eux à travers le fabricant), et assument la responsabilité des travaux qu'ils réalisent. Les frais correspondant aux services du S.A.T. seront uniquement assumés par le fabricant, lorsque le S.A.T. interviendra en qualité de SERVICE APRÈS-VENTE, si le produit est en période de GARANTIE, après vérification préalable et reconnaissance, de la part du département technique de cette compagnie, du vice de fabrication, communiqué dans le respect des modalités et des délais, le S.A.T. répondant également de ses services dans ce cas-là

7. Les dommages produits par des travaux de plomberie, maçonnerie, menuiserie, etc. s'étant avérés nécessaires pour procéder à l'installation du produit ou appareil au domicile de l'utilisateur.

8. Les travaux ou frais supplémentaires et transformations des arrivées d'eau, d'électricité, de gaz, des systèmes d'écoulement, etc. s'avérant nécessaires pour l'installation des produits couverts par la Garantie.

9. Le remplacement de produits perdant leur fonctionnalité au fil de leur utilisation, cartouches, flexibles, filtres, rondelles d'étanchéité, etc.

10. Produits d'exposition et similaires.

Aucune personne ni entité n'est autorisée à introduire une quelconque modification (verbale ou écrite) sur cette garantie.



Art direction and graphic design

Sanycces design team

Photography

Vicent Clausell (Clausell studio)

Print

Imedisa



Pol. Ind. Carabona
C/ Coure P-11 Apdo. 158
12530 Burriana (Castellón) SPAIN
Tel. +34 964 518 202
info@sanycces.es
www.sanycces.es

Sanycces se reserva el derecho a anular o modificar los productos o cualquiera de sus atributos que aparecen en este catálogo. La reproducción de los colores es aproximada.

Sanycces reserves the right to cancel or modify the products or any of their attributes appearing in this catalogue. Colour reproduction is approximate.

Sanycces se réserve le droit d'annuler ou de modifier les produits ou l'un de leurs attributs figurant dans ce catalogue. La reproduction des couleurs est approximative.