

sanycces

mediterranean design

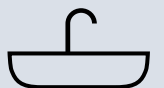

2022 COLLECTION

Basins
Lavabos
Vasques

sanycces
basins collection

| | |
|-------|---|
| Intro | 5 |
|-------|---|

Products

Solid Sanycces®

| | |
|--------|----|
| Kaliya | 14 |
|--------|----|

| | |
|------|----|
| Cork | 18 |
|------|----|

| | |
|---------|----|
| Bristol | 22 |
|---------|----|

| | |
|--------------|----|
| Cardiff Muro | 26 |
|--------------|----|

| | |
|------|----|
| Rust | 34 |
|------|----|

| | |
|--------|----|
| Eslida | 38 |
|--------|----|

| | |
|--------|----|
| Lucena | 42 |
|--------|----|

| | |
|--------|----|
| Artana | 46 |
|--------|----|

| | |
|---------|----|
| Classic | 50 |
|---------|----|

| | |
|---------|----|
| Cabanes | 56 |
|---------|----|

| | |
|------------|----|
| Vistabella | 60 |
|------------|----|

Products

Sanydur gel coat

| | |
|------|----|
| Ture | 66 |
|------|----|

| | |
|------|----|
| Sira | 70 |
|------|----|

| | |
|-------|----|
| Nadir | 74 |
|-------|----|

| | |
|-----|----|
| Bol | 82 |
|-----|----|

| | |
|--------|----|
| Bol TP | 88 |
|--------|----|

| | |
|-------|----|
| Rondo | 94 |
|-------|----|

| | |
|--------|-----|
| Cuadra | 102 |
|--------|-----|

| | |
|-------|-----|
| Circo | 102 |
|-------|-----|

| | |
|-------------|-----|
| Clever Easy | 112 |
|-------------|-----|

| | |
|------------|-----|
| Clever Duo | 114 |
|------------|-----|

index

Products

Ceramic Vitreous

Basins Selection

Padova 124

Marsala 128

Catania 134

Trapani 138

Modena 140

Project Line

Palermo 144

Marino 146

Chiure 148

Pisa 150

Napoli 152

Lecce 154

Verona 156

Bergamo 158

Cagliary 160

Balta 162

Parma 164

Products

Ceramic Vitreous

XS Basins

Petit 168

Mini 172

Cosenza 174

Countertops

Zero 192

Materialles 199

General info 211

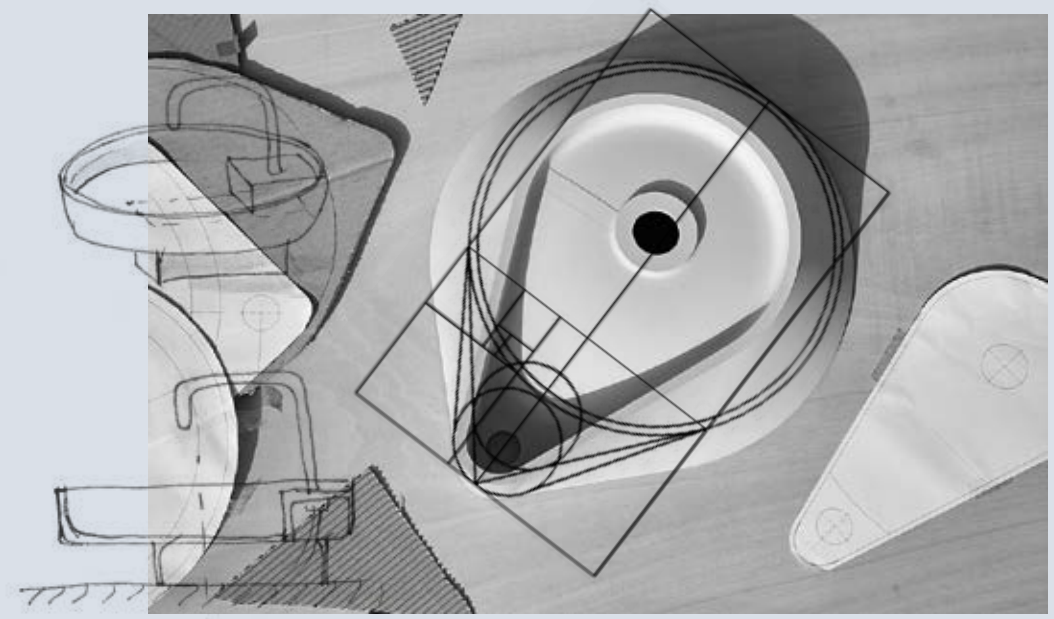
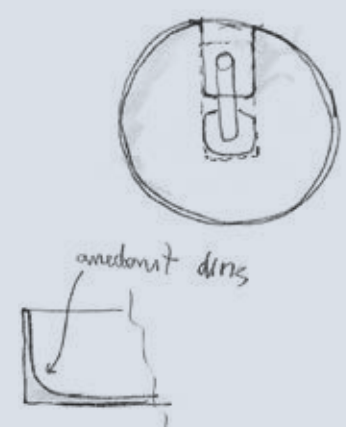
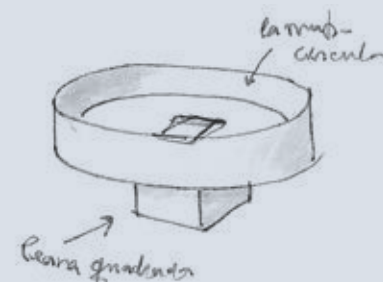
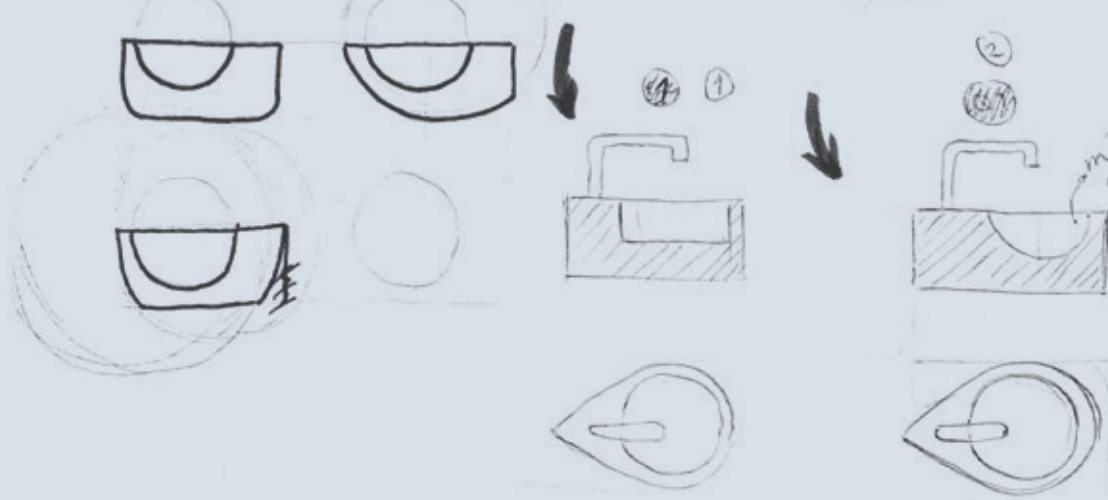
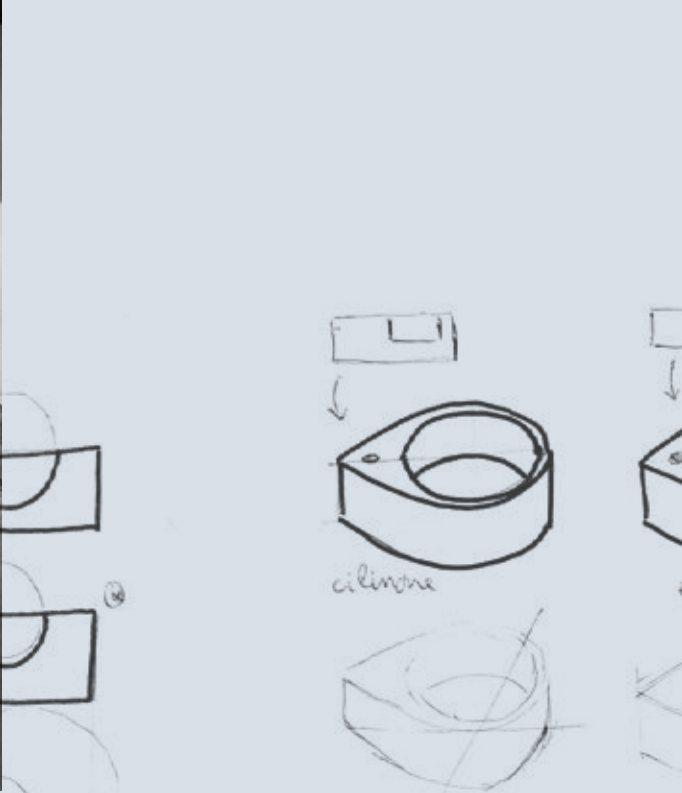



Sanycces es una empresa que diseña, fabrica y vende equipamiento para el baño cuidando aspectos estéticos, prácticos y de sostenibilidad.

Con la vista puesta en el futuro nuestro equipo de diseño interno se apoya en diseñadores emergentes y consolidados para idear nuevas soluciones para el baño.

Sanycces is a company that designs, manufactures and sells bathroom equipment with a focus on aesthetics, practicality and sustainability.

With an eye to the future, our in-house design team relies on emerging and established designers to come up with new solutions for the bathroom.

sanycces

Sanycces est une entreprise qui conçoit, fabrique et vend des équipements de salle de bains en mettant l'accent sur l'esthétique, la praticité et la durabilité.

Tournée vers l'avenir, notre équipe de conception interne s'appuie sur des designers émergents ou confirmés pour proposer de nouvelles solutions pour la salle de bains.

CLAUSELL studio

Clausellstudio es un estudio dedicado fundamentalmente al diseño industrial y asesoramiento en el desarrollo de productos, abarcando también otros servicios relacionados.

Una de las primeras premisas que tiene para llevar a cabo un proyecto es conseguir una alta calidad técnica y estética, gracias a una extrema simplicidad formal y una cuidada selección de materiales.

La pasión por el trabajo, las variadas influencias recibidas y los requerimientos del cliente se cocinan en el estudio a fuego lento para obtener un exquisito producto fruto de una buena combinación de los elementos con sabor mediterráneo.

Clausellstudio is a studio dedicated primarily to industrial design and advice on product development, also covering other related services.

One of the first premises when carrying out a project is to achieve a high technical and aesthetic quality, thanks to an extreme formal simplicity and a careful selection of materials.

The passion for the work, the varied influences received and the client's requirements are simmered in the studio to obtain an exquisite product that is the result of a good combination of elements with a Mediterranean flavour.



Vicent Clausell

Clausellstudio est un studio qui se consacre principalement au design industriel et au conseil en matière de développement de produits, et qui couvre également d'autres services connexes.

L'une des premières prémisses lors de la réalisation d'un projet est d'atteindre une haute qualité technique et esthétique, grâce à une extrême simplicité formelle et une sélection soignée des matériaux. La passion du travail, les diverses influences reçues et les exigences du client sont mijotées dans l'atelier pour obtenir un produit exquis qui est le résultat d'une bonne combinaison d'éléments à saveur méditerranéenne.



Washbasins

Lavabos

Vasques

A pared
Wall hung
Suspendú

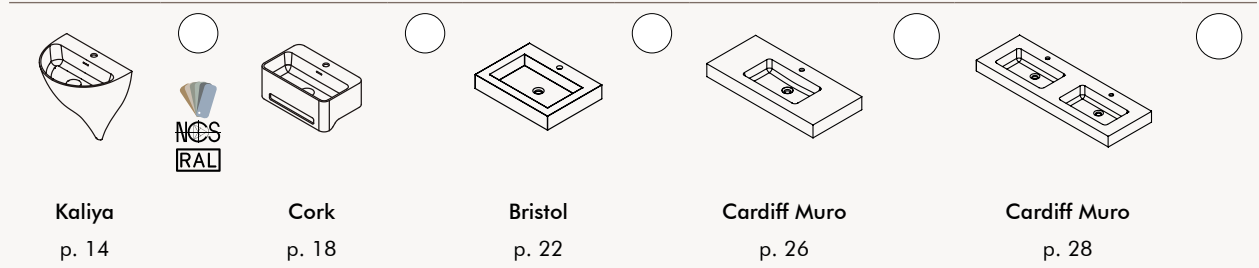

Sobre encimera
Over work top
Sur comptoir

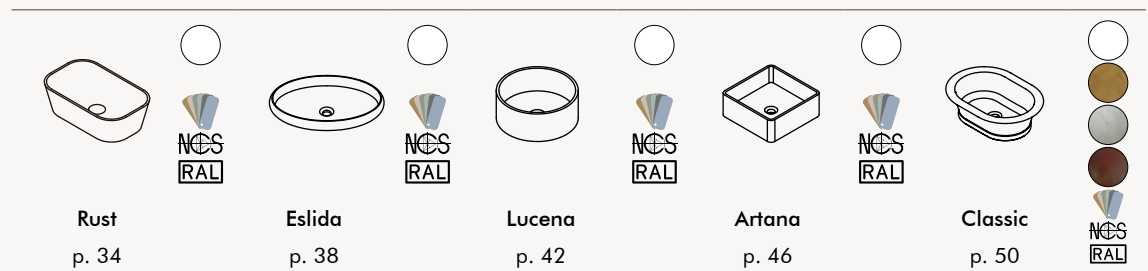

Exento
Freestanding
En îlot

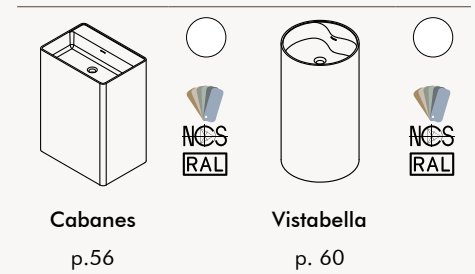

sanydur gel coat

Sobre encimera
Over work top
Sur comptoir

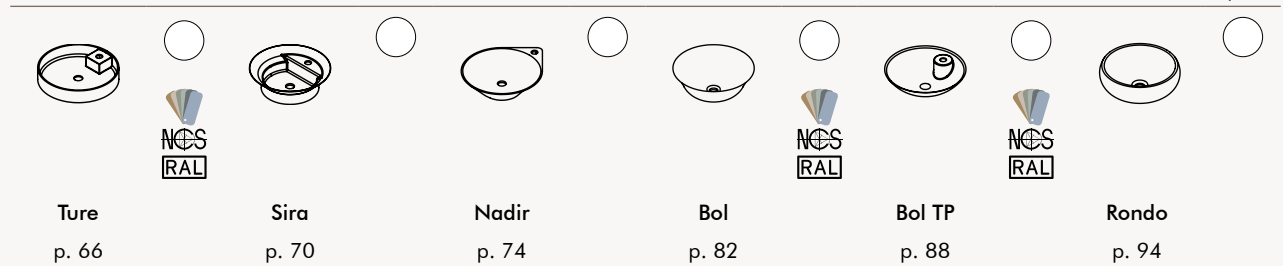

Sobre encimera
Over work top
Sur comptoir

Exento
Freestanding
En îlot



Washbasins

Lavabos

Vasques

ceramicvitreous

basins selection

Sobre encimera
Over work top
Sur comptoir



Padova
p. 124



Marsala
p. 128



Catania
p. 134

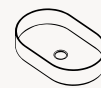

Trapani
p. 138



Modena
p. 140



project line

Sobre encimera
Over work top
Sur comptoir



Palermo
p. 144

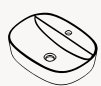

Marino
p. 146



Chiure
p. 148

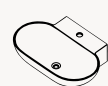

Pisa
p. 150



Napoli
p. 152

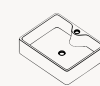

Lecce
p. 154



Verona
p. 156



Bergamo
p. 158

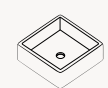

Cagliari
p. 160



Balta
p. 162

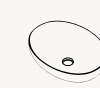

Parma
p. 164



XS basins

Sobre encimera
Over work top
Sur comptoir



Petit
p. 168



Mini
p. 172

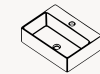

Cosenza
p. 174



sandyur gel coat

naturalwood

A pared
Wall hung
Suspendú

Bajoencimeras
Undercounter
Surcomptois

Encimeras
Countertops
Comptois

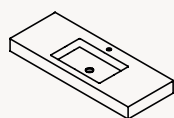

Clever
p. 112

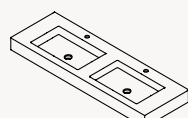

Clever
p. 114

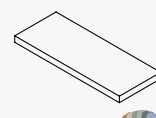
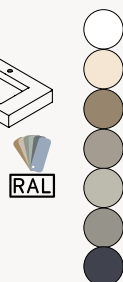

Clever
p. 112

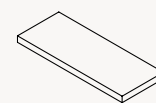

Zero
p. 192







solid[®]
sanycces

solid[®]





solid[®]
sanycces

Wall mounted

solid[®]



Kaliya

Solid Sanycces®

50x38x57h



○ Blanco mate
Matt white
Blanc mate

Design by:

CLAUSELL
1952





Kaliya

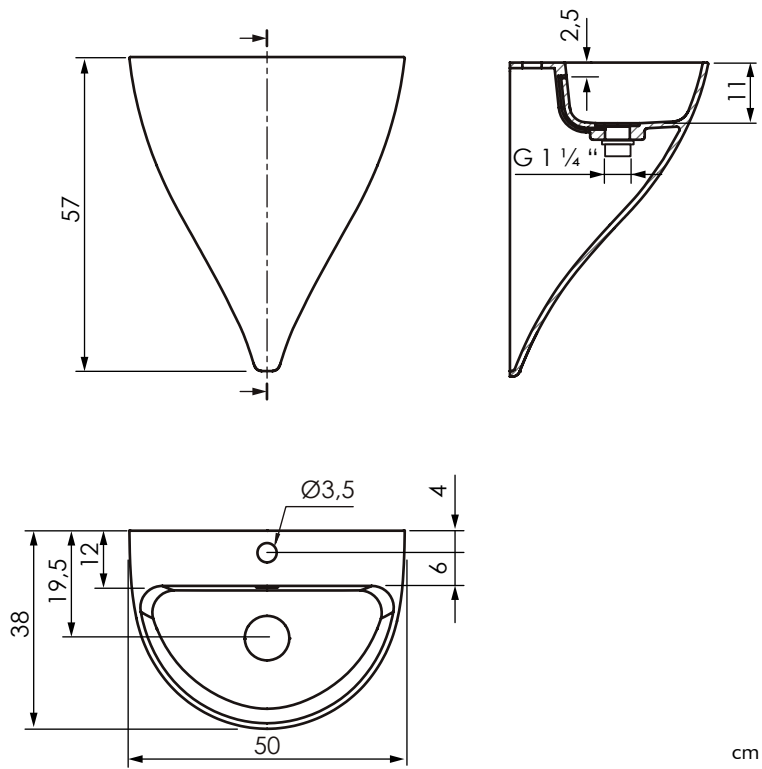





Componentes de instalación incluidos
Installation fittings included
Composants d'installation inclus



Desagüe click-clack **Solid Sanycces®** incluido
Solid Sanycces® pop-up drain included
Bonde click-clack **Solid Sanycces®** incluse

Para lavabo sin agujero de grifería, consultar disponibilidad y plazos
For washbasin without tap hole, consult availability and deadlines
Pour vasque sans perçage pour robinetterie, consulter disponibilité et délai

Lavabo / Washbasin / Vasque

| | | | | | | | |
|---|--|--|---|---|--|--|------------|
| | | | | | |  Blanco mate Matt white Blanc mate | |
| | | | | | | | LASS009 |
| | | |  Kaliya | | | | 700 € |
|  | | |  Kaliya | * | | | LASS009RAL |
| | | | | | | | 900 € |

Opciones / Options / Options

| | | | | | | | |
|--|--|--|---|----|--|--|----------|
| | | | | | | | SOLIDMEC |
| | | |  Mecanizado para grifería Tap holes Trous pour robinet | ** | | | 65 € |

* Especificar el RAL / NCS en el pedido.

* Specify the RAL / NCS in the order.

* Spécifiez le RAL / NCS dans la commande.

** El cliente debe aportar el plano de taladrado.

** The customer must provide the drilling plan.

** Le client doit fournir le plan de perçage.

Cork

Solid Sanycces®

50x31x20h



○ Blanco mate
Matt white
Blanc mate

Design by:

CLAUSEL





Cork

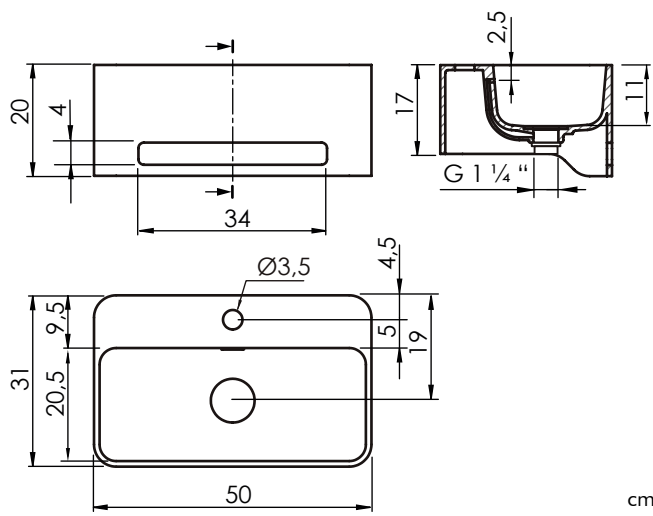

cm



Componentes de instalación incluidos
Installation fittings included
Composants d'installation inclus



Desagüe click-clack **Solid Sanycces®** incluido
Solid Sanycces® pop-up drain included
Bonde click-clack **Solid Sanycces®** incluse

Para lavabo sin agujero de grifería, consultar disponibilidad y plazos
For washbasin without tap hole, consult availability and deadlines
Pour vasque sans perçage pour robinetterie, consulter disponibilité et délai

Lavabo / Washbasin / Vasque



Cork



Blanco mate
Matt white
Blanc mate

LASS010

520 €

Opciones / Options / Options



Mecanizado para grifería
Tap holes
Trous pour robinet

*

SOLIDMEC

65 €

* El cliente debe aportar el plano de taladrado.

* The customer must provide the drilling plan.

* Le client doit fournir le plan de perçage.

Bristol

Solid Sanycces®

60x45x10h



- Blanco mate
- Matt white
- Blanc mate





Bristol

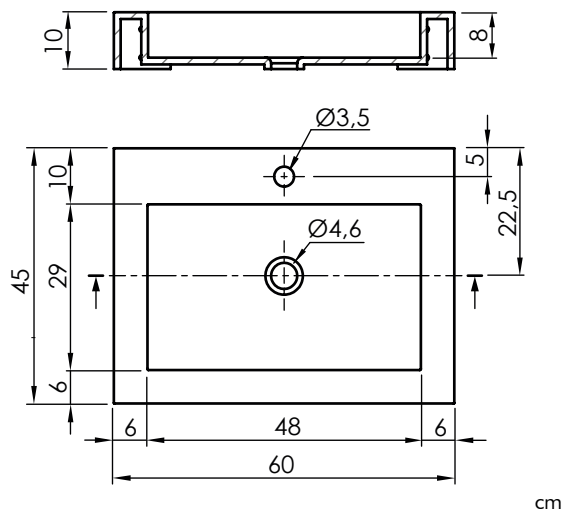

cm

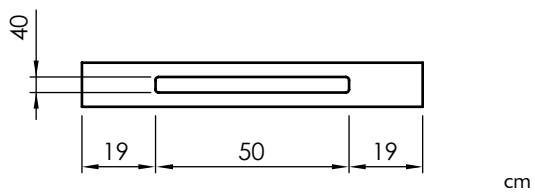

cm

Opción toallero frontal
Front towel rail option
Option porte-serviettes frontale

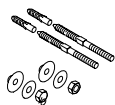

Componentes de instalación incluidos
Installation fittings included
Composants d'installation inclus

Para lavabo sin agujero de grifería, consultar disponibilidad y plazos
For washbasin without tap hole, consult availability and deadlines
Pour vasque sans perçage pour robinetterie, consulter disponibilité et délai

Lavabo / Washbasin / Vasque



Bristol

Blanco mate
Matt white
Blanc mate

LASS012

420 €

Opciones / Options / Options



Mecanizado para grifería
Tap holes
Trous pour robinet

*

SOLIDMEC

65 €



Mecanizado para toallero
frontal
Front towel rail
Porte-serviettes frontale

SOLIDTWMEC

110 €

* El cliente debe aportar el plano de taladrado.

* The customer must provide the drilling plan.

* Le client doit fournir le plan de perçage.

Cardiff muro

Solid Sanycces®

80x46x10h

100x46x10h

120x46x10h



○ Blanco mate
Matt white
Blanc mate





Cardiff muro





Cardiff Muro

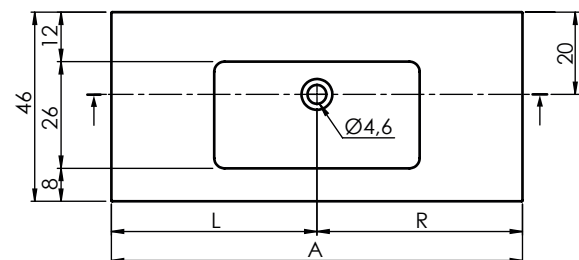
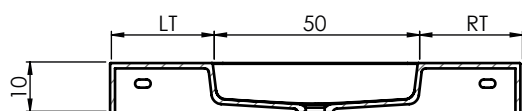

cm

| dim. cm | A | L | R | LT | RT |
|---------|-----|----|----|----|----|
| 80x46 | 80 | 40 | 40 | 15 | 15 |
| 100x46 | 100 | 50 | 50 | 25 | 25 |
| 120x46 | 120 | 60 | 60 | 35 | 35 |

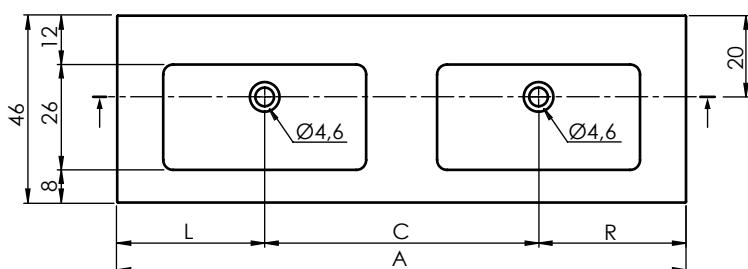
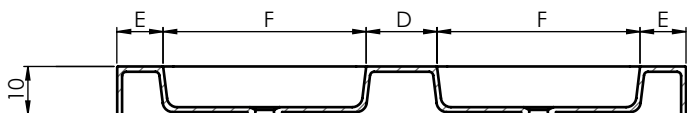

cm

| dim.cm | A | C | D | E | F | L | R |
|--------|-----|------|------|------|----|------|------|
| 120x46 | 120 | 62,5 | 22,5 | 8,8 | 40 | 28,5 | 28,5 |
| 140x46 | 140 | 67,5 | 17,5 | 11,5 | 50 | 36 | 36 |
| 160x46 | 160 | 77,5 | 27,5 | 16,5 | 50 | 41 | 41 |

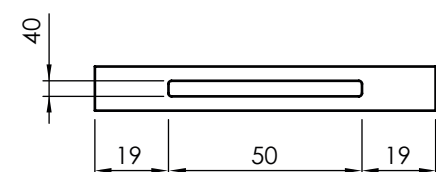

cm



Opción toallero frontal
Front towel rail option
Option porte-serviettes frontal





Componentes de instalación incluidos
Installation fittings included
Composants d'installation inclus

Lavabo sin agujero de grifería.
Washbasin without tap hole.
Vasque sans perçage pour robinetterie.



Lavabo / Washbasin / Vasque

| | | |
|---|--|---|
| | |  |
| | | Blanco mate Matt white Blanc mate |
| | | LASS016801S |
| Cardiff Muro 80x46 | | 497 € |
| | | LASS0161001S |
| Cardiff Muro 100x46 | | 547 € |
|  Cardiff Muro 120x46 | | LASS0161201S |
| | | 646 € |

Lavabo / Washbasin / Vasque

| | | |
|---|--|--|
| | |  |
| | | Blanco mate Matt white Blanc mate |
| | | LASS0161202S |
| Cardiff Muro 120x46 | | 663 € |
| | | LASS0161402S |
| Cardiff Muro 140x46 | | 733 € |
|  Cardiff Muro 160x46 | | LASS0161602S |
| | | 857 € |

Opciones / Options / Options

| | | | |
|---|---|----|------------|
|  | Mecanizado para grifería Tap holes Trous pour robinet | * | SOLIDMEC |
| | | | 65 € |
|  | Mecanizado para toallero frontal Front towel rail Porte-serviettes frontale | ** | SOLIDTWMEC |
| | | | 110 € |

* El cliente debe aportar el plano de taladrado.

* The customer must provide the drilling plan.

* Le client doit fournir le plan de perçage.

** Si el lavabo es doble será necesarios dos mecanizados. 2 x SOLIDTWMEC

** If the basin is a double basin, two machining operations will be necessary. 2 x SOLIDTWMEC

** Si le bassin est un bassin double, deux opérations d'usinage seront nécessaires. 2 x SOLIDTWMEC



solid[®]

sanycces

On top

solid[®]



Rust

Solid Sanycces®

50x31x15h



○ Blanco mate
Matt white
Blanc mate

Design by:

CLAUSEL

+ Rust series



Bañera
Bathtub
Baignoire

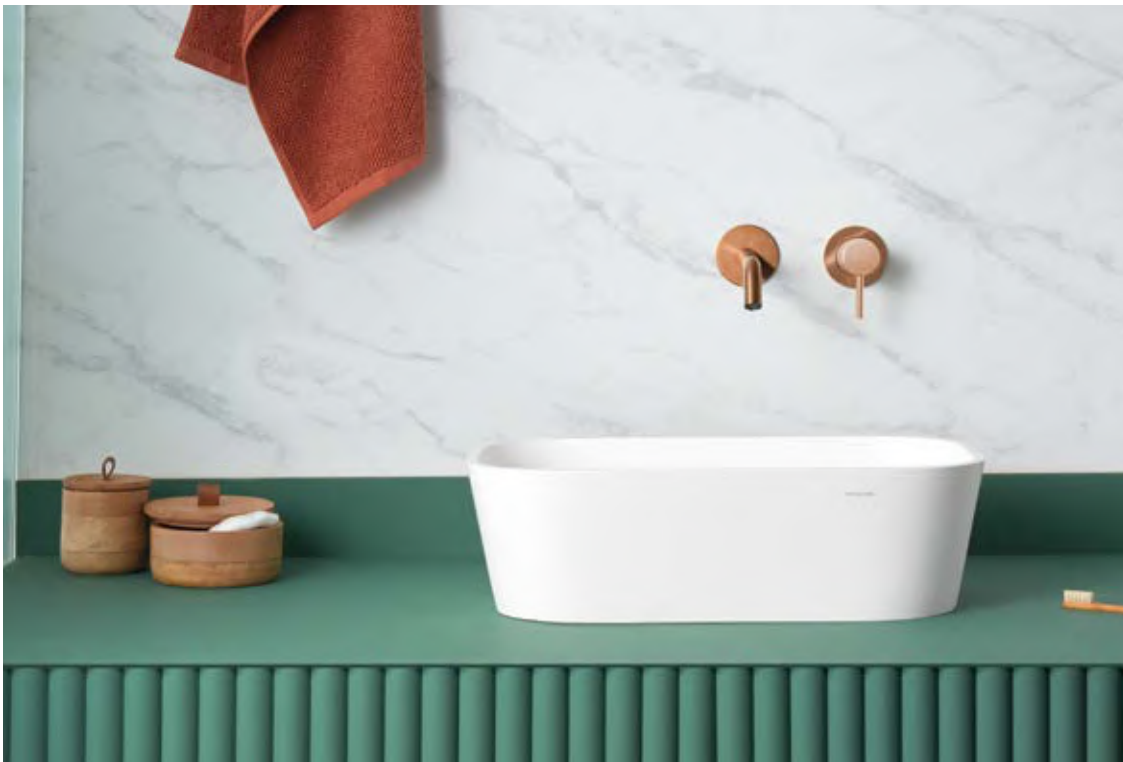



Rust

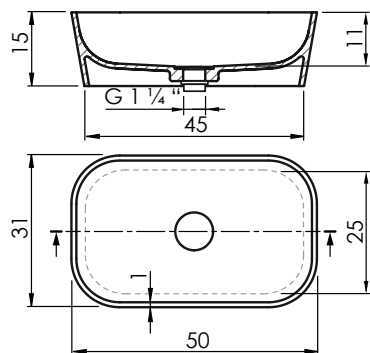





cm



Desagüe click-clack **Sanycces**® incluido
Solid Sanycces® pop-up drain included
Bonde click-clack **Sanycces**® incluse

Lavabo / Washbasin / Vasque

| | | | | |
|---|---|------|---|--|
| | | | |  <p>Blanco mate Matt white Blanc mate</p> |
| | | | | LASS011 |
| |  | Rust | | 420 € |
|  | | | | LASS011RAL |
| |  | Rust | * | 650 € |

* Especificar el RAL / NCS en el pedido.

* Specify the RAL / NCS in the order.

* Spécifiez le RAL / NCS dans la commande.

Eslida

Solid Sanycces®

60x40x11h



- Blanco mate
- Matt white
- Blanc mate







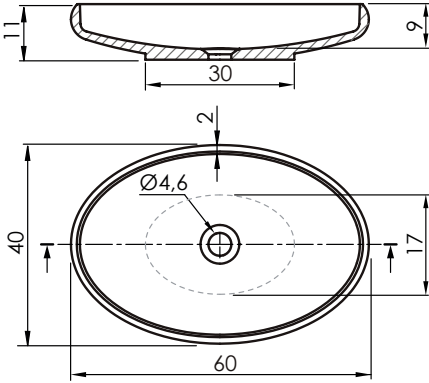

Eslida



cm

Lavabo / Washbasin / Vasque

| | | | | | |
|---|---|--------|---|--|--|
| | | | | |  <p>Blanco mate Matt white Blanc mate</p> |
| | | | | | LASS006 |
| |  | Eslida | | | 340 € |
|  | | | | | LASS006RAL |
| |  | Eslida | * | | 580 € |

* Especificar el RAL / NCS en el pedido.

* Specify the RAL / NCS in the order.

* Spécifiez le RAL / NCS dans la commande.

Lucena

Solid Sanycces®

Ø40x15h



Blanco mate
Matt white
Blanc mate







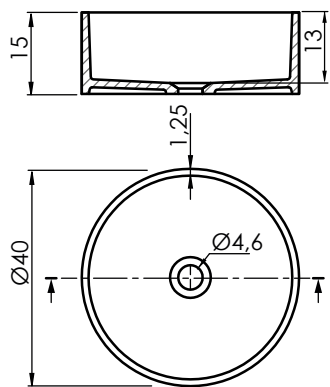

Lucena



cm

Lavabo / Washbasin / Vasque

| | | | | | | |
|---|---|--------|---|--|------------|-------|
|  |  | Lucena | |  <p>Blanco mate Matt white Blanc mate</p> | LASS001 | 340 € |
| |  | Lucena | * | | LASS001RAL | 580 € |

* Especificar el RAL / NCS en el pedido.

* Specify the RAL / NCS in the order.

* Spécifiez le RAL / NCS dans la commande.

Artana

Solid Sanycces®

40x40x15h



- Blanco mate
- Matt white
- Blanc mate







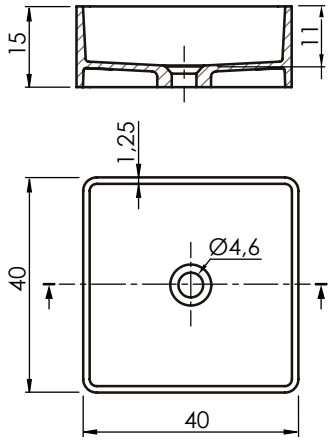

Artana



cm

Lavabo / Washbasin / Vasque

| | | | | | | |
|---|---|--------|---|--|---------|------------|
|  |  | Artana | |  <p>Blanco mate Matt white Blanc mate</p> | LASS002 | 350 € |
| | <hr/> | | | | | |
| |  | Artana | * | | | LASS002RAL |

* Especificar el RAL / NCS en el pedido.

* Specify the RAL / NCS in the order.

* Spécifiez le RAL / NCS dans la commande.

Classic

Solid Sanycces®

50x36x15h



○ Blanco mate
Matt white
Blanc mate

+ Classic series



Bañera
Bathtub
Baignoire





Classic

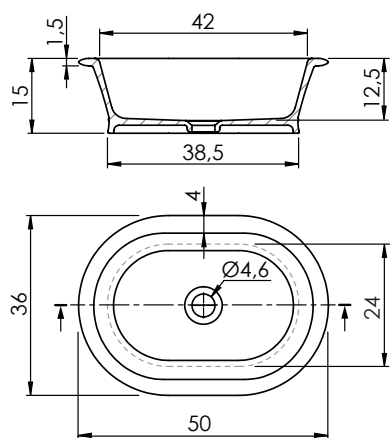

cm



sanycoat
gold



sanycoat
silver

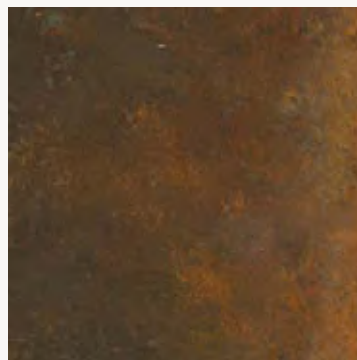

sanycoat
rust

sanycoat
Acabado especial
Special finish
Finition spéciale



solid®
sanycces

Freestanding

solid®



Cabanes

Solid Sanycces®

60x42x90h



○ Blanco mate
Matt white
Blanc mate

+ Cabanes series



Bañera
Bathtub
Baignoire





Cabanes

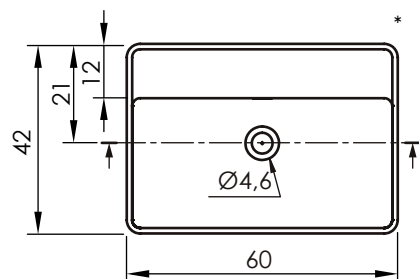
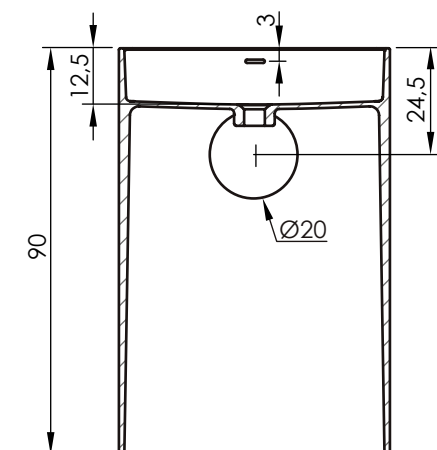

cm

- * Lavabo sin agujero para grifería.
- * Washbasin without hole for taps.
- * Lavabo sans trou pour robinetterie.

Lavabo / Washbasin / Vasque

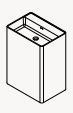
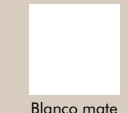
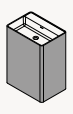
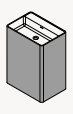
| | | | | |
|---|---|---------|---|---|
|  |  | | |  |
| | | Cabanes | | Blanco mate Matt white Blanc mate |
| | | | | LASS007 |
| |  | Cabanes | * | LASS007RAL |
| | | | | 1.200 € |
| |  | Cabanes | * | LASS007RAL |
| | | | | 1.550 € |

Opciones / Options / Options

| | | | |
|--|---|----|----------|
|  | Mecanizado para grifería Tap holes Trous pour robinet | ** | SOLIDMEC |
| | | | 65 € |

* Especificar el RAL / NCS en el pedido.

* Specify the RAL / NCS in the order.

* Spécifiez le RAL / NCS dans la commande.

** El cliente debe aportar el plano de taladrado.

** The customer must provide the drilling plan.

** Le client doit fournir le plan de perçage.

Vistabella

Solid Sanycces®

Ø45x90h



○ Blanco mate
Matt white
Blanc mate







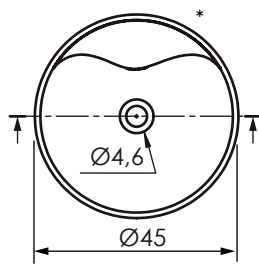
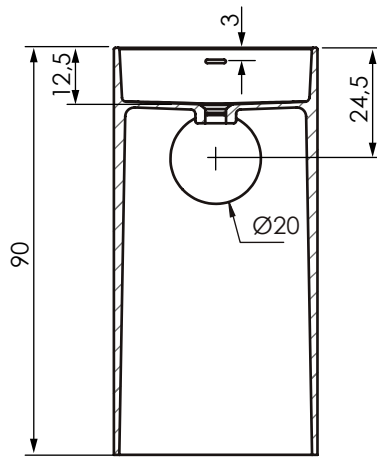

Vistabella



cm

- * Lavabo sin agujero para grifería.
- * Washbasin without hole for taps.
- * Lavabo sans trou pour robinetterie.

Lavabo / Washbasin / Vasque

| | | | |
|---|---|--|---------|
| | |  <p>Blanco mate Matt white Blanc mate</p> | |
| |  <p>Vistabella</p> | LASS008 | 980 € |
|  |  <p>Vistabella</p> | LASS008RAL | 1.400 € |
| | | * | |

Opciones / Options / Options

| | | | |
|---|----|----------|------|
|  <p>Mecanizado para grifería Tap holes Trous pour robinet</p> | ** | SOLIDMEC | 65 € |
|---|----|----------|------|

* Especificar el RAL / NCS en el pedido.

* Specify the RAL / NCS in the order.

* Spécifiez le RAL / NCS dans la commande.

** El cliente debe aportar el plano de taladrado.

** The customer must provide the drilling plan.

** Le client doit fournir le plan de perçage.



sanydur gel coat



Ture

sanydur gel coat matt

Ø42x13,5h



○ Blanco mate
Matt white
Blanc mate

Design by:

CLAUSELL
DESIGN





Ture

Design by:

CLAUSELL





Sira

sanydur gel coat matt

Ø42x12,5h



○ Blanco mate
Matt white
Blanc mate

Design by:

CLAUSELL
DESIGN





Sira

Design by:

CLAUSEL





Nadir

sanydur gel coat matt

Ø43,5x10h



○ Blanco mate
Matt white
Blanc mate

Design by:

CLAUSELL
DESIGN





Nadir

Design by:

CLAUSELL
made in italy





Ture

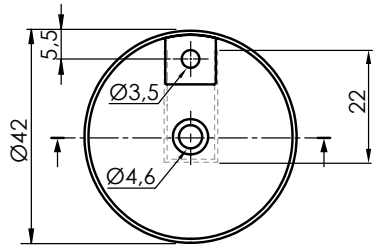
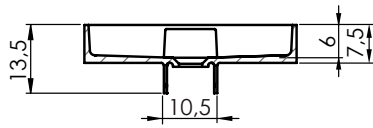

cm

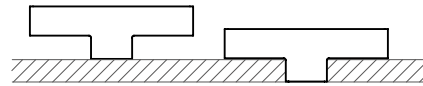

Sobre encimera
On top
Sur comptoir

De encimera
In countertop
À encastrer

Sira

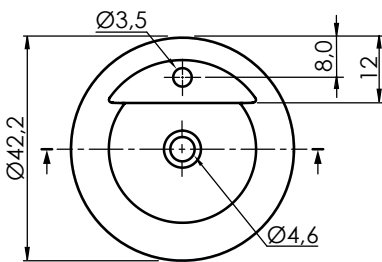
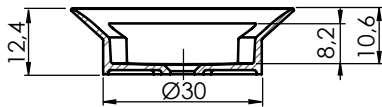





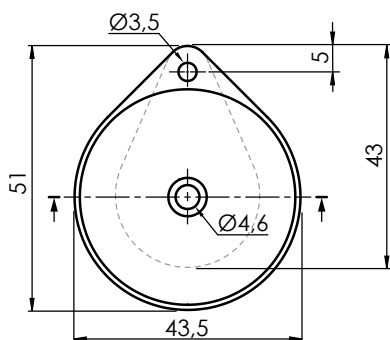
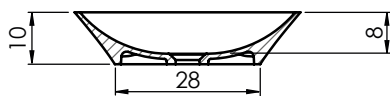





cm

Nadir





cm

Lavabo / Washbasin / Vasque

| | | | | | |
|---|---|-------|---|----------|--|
| | | | | |  Blanco mate Matt white Blanc mate |
| | | | | LA012 | |
| |  | Ture | | | 368 € |
|  |  | Ture | * | LA012RAL | 550 € |
| | | | | | |
| | | | | LA011 | |
| |  | Sira | | | 336 € |
|  |  | Sira | * | LA011RAL | 589 € |
| | | | | | |
| | | | | LA010 | |
| |  | Nadir | | | 315 € |
|  |  | Nadir | * | LA010RAL | 577 € |
| | | | | | |

sanydur

Lavabo / Washbasin / Vasque

| | | | | | |
|--|---|---|--|------------|---|
| | | | | |  Blanco mat Matt white Blanc mate |
| | | | | ACCLV010BM | |
| |  | Desagüe click-clack Sanydur Sanydur pop-up brass waste Bonde click-clack en Sanydur | | | 60 € |

* Especificar el RAL / NCS en el pedido.

* Specify the RAL / NCS in the order.

* Spécifiez le RAL / NCS dans la commande.



Bol

sanydur



 Bol Ø41x15h

Bol

sanydur gel coat matt

Ø41x12h

Ø41x15h



Blanco mate
Matt white
Blanc mate



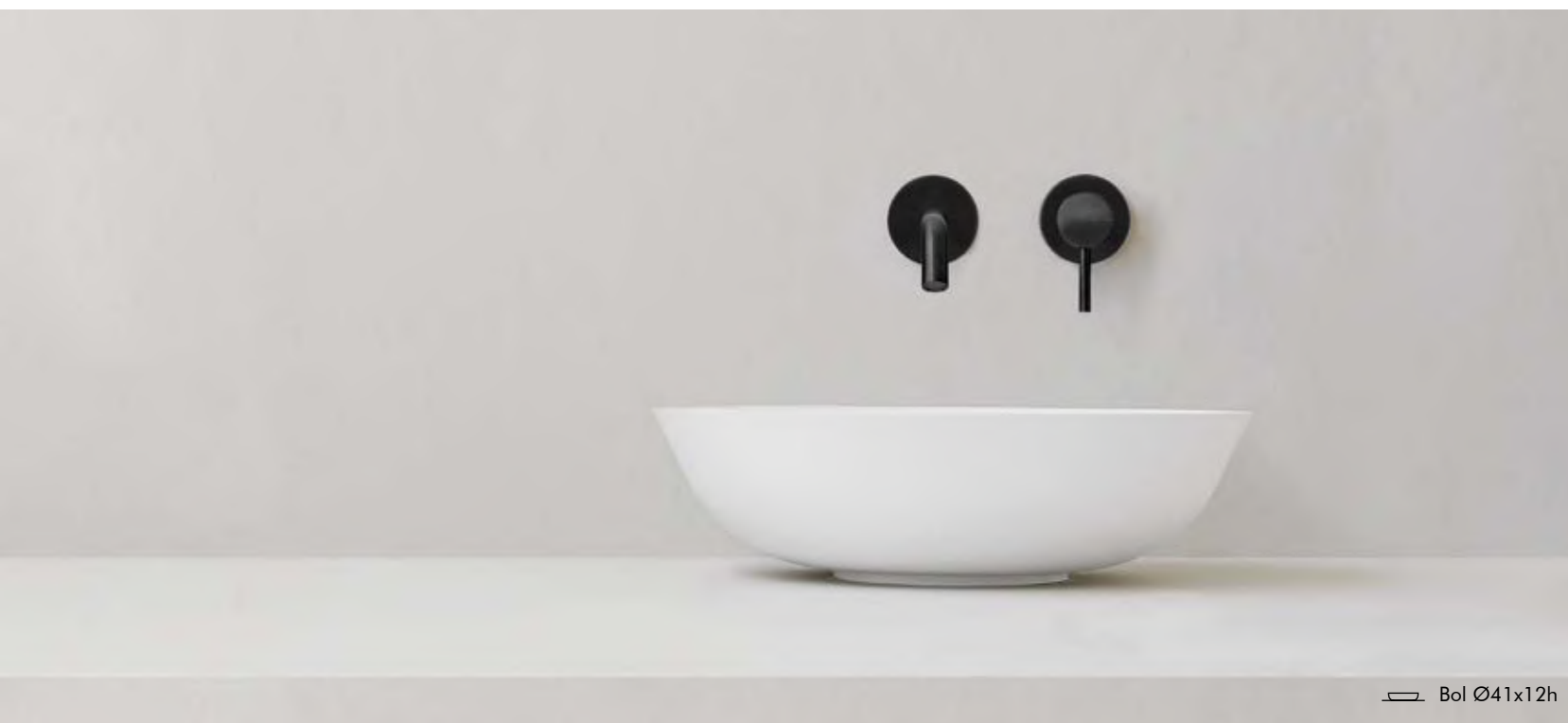

☐ Bol Ø41x12h



☐ Bol Ø41x15h



— Bol Ø41x15h



 Bol Ø41x12h

Bol



 Bol Ø41x15h



Bol TP

sanydur gel coat matt

Ø43x12,5h



○ Blanco mate
Matt white
Blanc mate

Design by:

CLAUSELL
DESIGN





Bol TP

Design by:

CLAUSEL







 Rondo Ø36x12h

Rondo



sanydur

— Rondo Ø40x12h

Rondo

sanydur gel coat matt

Ø36x12h

Ø40x12h



○ Blanco mate
Matt white
Blanc mate

+ Rondo series



Bañera
Bathtub
Baignoire



 Rondo Ø40x12h



— Rondo Ø40x12h

Bol

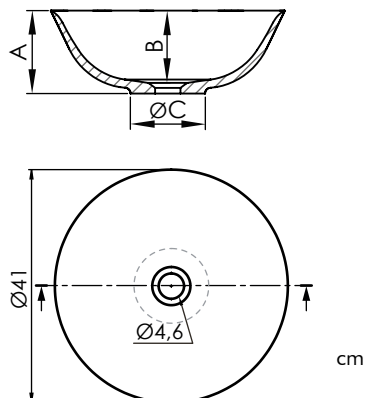





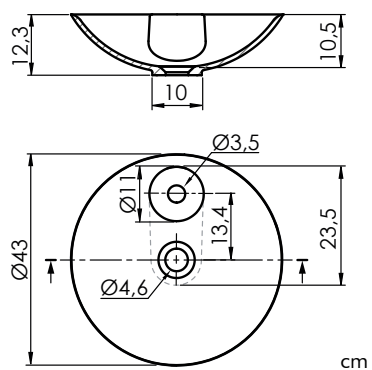





| A (cm) | B (cm) | C (cm) |
|--------|--------|--------|
| 12 | 9,5 | 13 |
| 15 | 12,5 | 16 |

Bol TP





Lavabo / Washbasin / Vasque

| | | | | | |
|---|---|------------------|---|--|--|
| | | | | |  Blanco mate Matt white Blanc mate |
| | | | | | LA00411 |
| |  | Bol Ø41x12h | | | 190 € |
|  | | | | | LA00411RAL |
| |  | Bol Ø41x12h | * | | 450 € |
| | | | | | LA004 |
| |  | Bol Ø41x15h | | | 200 € |
|  | | | | | LA004RAL |
| |  | Bol Ø41x15h | * | | 475 € |
| | | | | | LA00411TP |
| |  | Bol TP Ø43x12,3h | | | 315 € |
|  | | | | | LA00411TPRAL |
| |  | Bol TP Ø43x12,3h | * | | 550 € |

sanydur

Accesorios / Accessories / Accessoires

| | | | | | |
|--|---|---|--|--|---|
| | | | | |  Blanco mat Matt white Blanc mate |
| | | | | | ACCLV010BM |
| |  | Desagüe click-clack Sanydur Sanydur pop-up brass waste Bonde click-clack en Sanydur | | | 60 € |

* Especificar el RAL / NCS en el pedido.

* Specify the RAL / NCS in the order.





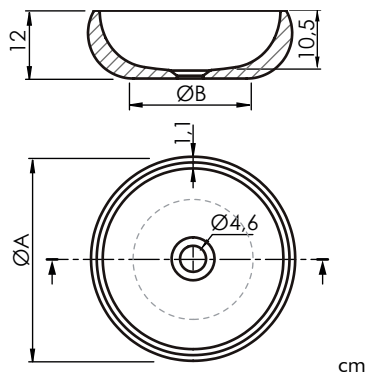

* Spécifiez le RAL / NCS dans la commande.

Rondo





| A (cm) | B (cm) |
|--------|--------|
| 36 | 20 |
| 40 | 30,5 |

Lavabo / Washbasin / Vasque

| | | | |
|--|--|-------------|--|
| | | |  <p>Blanco mate Matt white Blanc mate</p> |
| | | LA003036 | |
| |  Rondo Ø36 | 222 € | |
|  | | LA003036RAL | |
| |  Rondo Ø36 | 509 € | |
| | | LA003040 | |
| |  Rondo Ø40 | 249 € | |
|  | | LA003040RAL | |
| |  Rondo Ø40 | 538 € | |

sanydur

Accesorios / Accessories / Accessoires

| | | | |
|--|--|------------|---|
| | | |  <p>Blanco mat Matt white Blanc mate</p> |
| | | ACCLV010BM | |
| |  <p>Desagüe click-clack Sanydur Sanydur pop-up brass waste Bonde click-clack en Sanydur</p> | 60 € | |

* Especificar el RAL / NCS en el pedido.

* Specify the RAL / NCS in the order.

* Spécifiez le RAL / NCS dans la commande.



Cuadra / Circo



 Circo gloss white  Circo gloss white  Cuadra matt white  Cuadra matt white

Cuadra / Circo

sanydur gel coat

40x40x10,5h

Ø40x10,5h



40x40x90h

Ø40x90h



○ Blanco mate
Matt white
Blanc mate





○ Blanco brillo
White gloss
Blanc brillat



 Cuadra gloss white

 Cuadra matt white



 Cuadra gloss white  Circo gloss white  Cuadra matt white  Circo matt white

Cuadra / Circo





— Circo gloss white

□ Cuadra matt white

Cuadra / Circo



 Circo gloss white  Cuadra matt white



□ Circo matt white

□ Circo matt sanycot



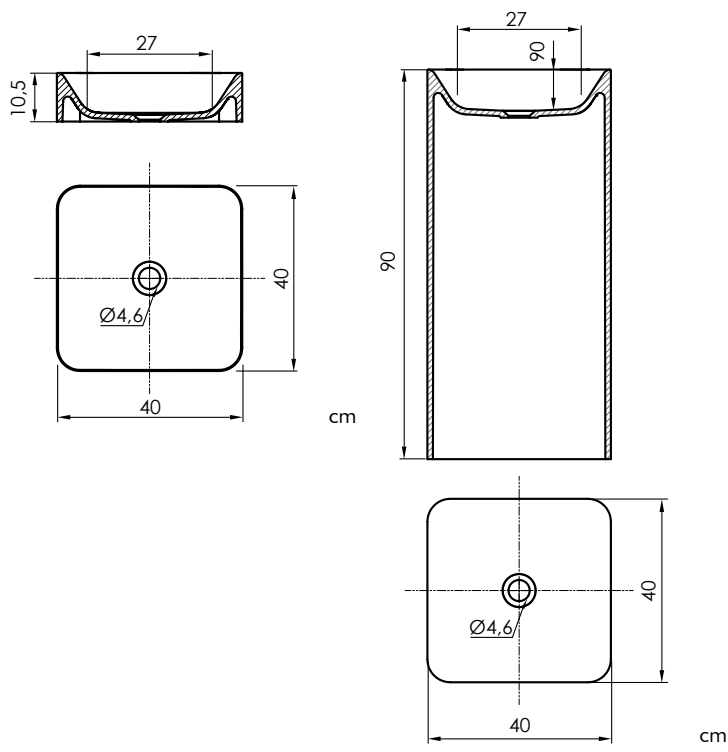

Cuadra

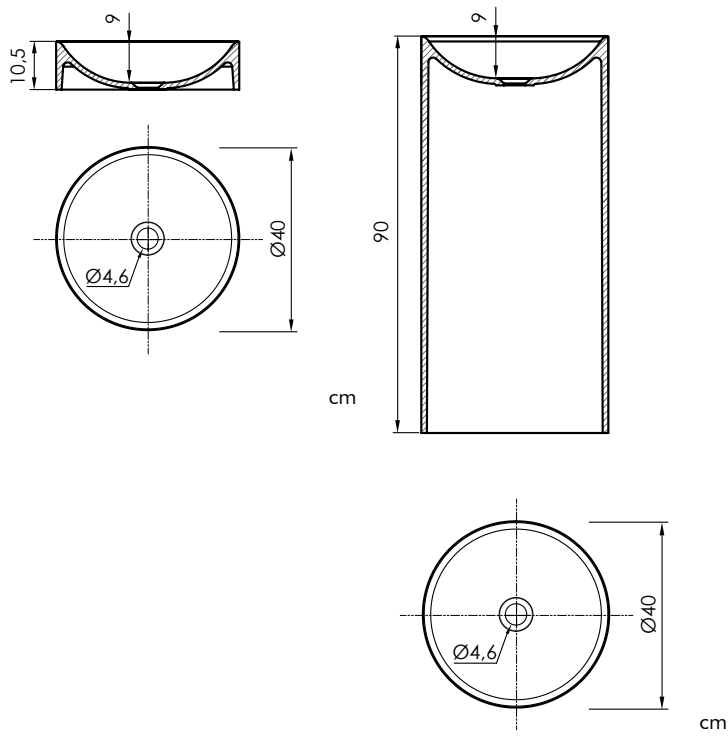



Circo



Lavabo / Washbasin / Vasque

| | | Blanco mate Matt white Blanc mate | Blanco brillo White gloss Blanc brillat |
|---|--|---|---|
|  |  Cuadra 40x40x10,5 cm | LA013OTBM 260 € | LA013OTBB 294 € |
| |  Cuadra 40x40x90 cm | LA013FSBM 845 € | LA013FSBB 884 € |
| |  Cuadra 40x40x10,5 cm * | LA013OTBMRAL 525 € | LA013OTBBRAL 566 € |
| |  Cuadra 40x40x90 cm * | LA013FSBMRAL 1.145 € | LA013FSBBRAL 1.179 € |

| | | | |
|---|---|-------------------------|-------------------------|
|  |  Circo Ø40x10,5 cm | LA014OTBM 250 € | LA014OTBB 280 € |
| |  Circo Ø40x90 cm | LA014FSBM 679 € | LA014FSBB 711 € |
| |  Circo Ø40x10,5 cm * | LA014OTBMRAL 515 € | LA014OTBBRAL 550 € |
| |  Circo Ø40x90 cm * | LA014FSBMRAL 1.050 € | LA014FSBBRAL 1.116 € |

Opciones / Options / Options

| | |
|---|------------------|
|  Mecanizado para desagüe Drain hole Drain trou | SOLIDMEC 65 € |
|---|------------------|

| | | Blanco mate Matt white Blanc mate | Blanco brillo White gloss Blanc brillat |
|---|--------------------|---|---|
|  Desagüe click-clack Sanydur Sanydur pop-up brass waste Bonde click-clack en Sanydur | ACCLV010BM 60 € | ACCLV010BB 80 € | |

* Especificar el RAL / NCS en el pedido.

* Specify the RAL / NCS in the order.

* Spécifiez le RAL / NCS dans la commande.



Clever



Clever easy

sanydur gel coat slate

70x46
80x46
100x46
120x46

sanydur slate

70-140x46



White
RAL9016

Cream
RAL1013

Cappuccino
NCS6010 Y30R

Elephant grey
NCS5005 Y50R

Light concrete
RAL7035

Concrete
RAL7030

Anthracite
RAL7016

+ Clever series



Plato
Shower tray
Receveur





Clever duo

sanydur gel coat slate

140x46



- White RAL9016
- Ceream RAL1013
- Cappuccino NCS6010 Y30R
- Elephant grey NCS5005 Y50R
- Light concrete RAL7035
- Concrete RAL7030
- Anthracite RAL7016

+ Clever series



Plato
Shower tray
Receveur





Clever

easy

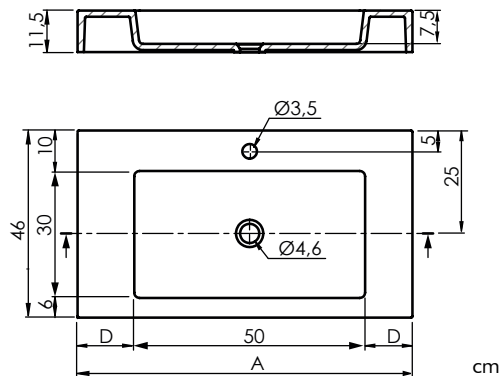

| dim.cm | A | D |
|--------|-----|----|
| 70x46 | 70 | 10 |
| 80x46 | 80 | 15 |
| 100x46 | 100 | 25 |
| 120x46 | 120 | 35 |

duo

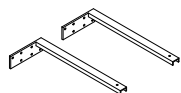
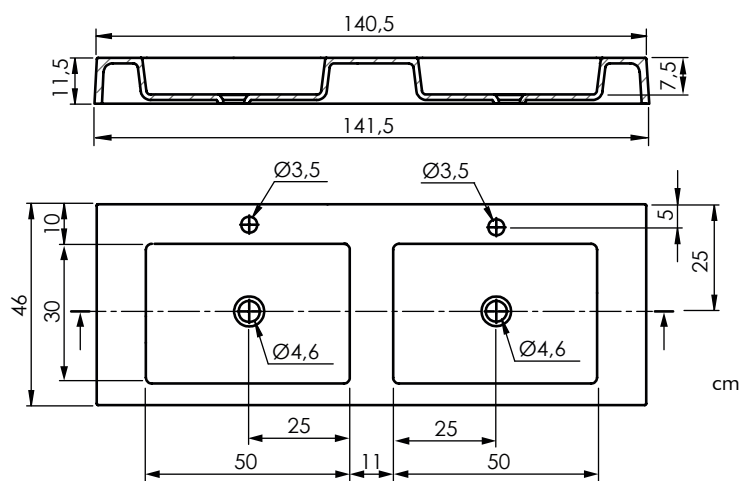

Componentes de instalación incluidos
 Installation fittings included
 Composants d'installation inclus

Lavabo / Washbasin / Vasque



| | White RAL9016 | Cream RAL1013 | Cappuccino NCS6010 Y30R | Elephant grey NCS5005 Y50R | Light concrete RAL7035 | Concrete RAL7030 | Anthracite RAL7016 | |
|--------------------|------------------|------------------|----------------------------|-------------------------------|---------------------------|---------------------|-----------------------|-------|
| Clever Easy 70x46 | LA1007045 | LA1017045 | LA1027045 | LA1037045 | LA1047045 | LA1057045 | LA1067045 | 475 € |
| Clever Easy 80x46 | LA1008045 | LA1018045 | LA1028045 | LA1038045 | LA1048045 | LA1058045 | LA1068045 | 544 € |
| Clever Easy 100x46 | LA10010045 | LA10110045 | LA10210045 | LA10310045 | LA10410045 | LA10510045 | LA10610045 | 657 € |
| Clever Easy 120x46 | LA10012045 | LA10112045 | LA10212045 | LA10312045 | LA10412045 | LA10512045 | LA10612045 | 756 € |



| Clever Easy 70x46 | * | | | | | | | CL7046RAL 570 € |
|--------------------|---|--|--|--|--|--|--|------------------|
| Clever Easy 80x46 | * | | | | | | | CL8046RAL 654 € |
| Clever Easy 100x46 | * | | | | | | | CL10046RAL 788 € |
| Clever Easy 120x46 | * | | | | | | | CL12046RAL 908 € |

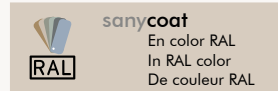

Lavabo / Washbasin / Vasque

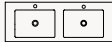

| | White RAL9016 | Cream RAL1013 | Cappuccino NCS6010 Y30R | Elephant grey NCS5005 Y50R | Light concrete RAL7035 | Concrete RAL7030 | Anthracite RAL7016 | |
|-------------------|------------------|------------------|----------------------------|-------------------------------|---------------------------|---------------------|-----------------------|-------|
| Clever Duo 140x46 | LA10014045 | LA10114045 | LA10214045 | LA10314045 | LA10414045 | LA10514045 | LA10614045 | 881 € |



| | | | | | | | | |
|-------------------|---|--|--|--|--|--|--|--------------------|
| Clever Duo 140x46 | * | | | | | | | CL14046RAL 1.058 € |
|-------------------|---|--|--|--|--|--|--|--------------------|



Los colores de las fotografías no son vinculantes, para una mejor identificación del color, consultar carta RAL o NCS.

The colors of the photographs are not binding, for a better identification of the color, consult RAL or NCS card.





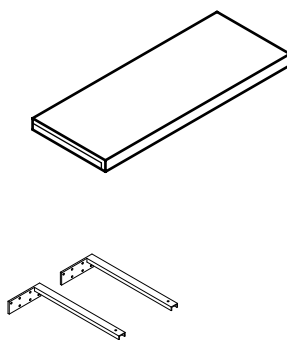
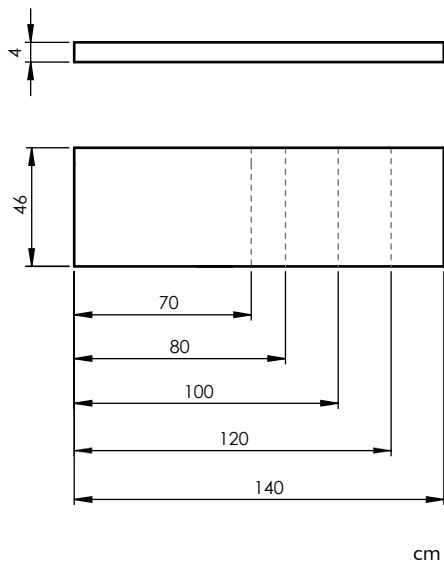



Les couleurs des photos peuvent être légèrement différentes. Pour une meilleure identification de la couleur, consultez les nuanciers RAL ou NCS.

Clever



Componentes de instalación incluidos
Installation fittings included
Composants d'installation inclus

Bajo encimera / Undercounter / Comptoir

| |  White RAL9016 |  Cream RAL1013 |  Cappuccino NCS6010 Y30R |  Elephant grey NCS5005 Y50R |  Light concrete RAL7035 |  Concrete RAL7030 |  Anthracite RAL7016 | |
|--------|---|--|--|--|---|---|---|-------|
| 70x46 | ENC107046 | ENC117046 | ENC127046 | ENC137046 | ENC147046 | ENC157046 | ENC167046 | 323 € |
| 80x46 | ENC108046 | ENC118046 | ENC128046 | ENC138046 | ENC148046 | ENC158046 | ENC168046 | 368 € |
| 100x46 | ENC1010046 | ENC1110046 | ENC1210046 | ENC1310046 | ENC1410046 | ENC1510046 | ENC1610046 | 457 € |
| 120x46 | ENC1012046 | ENC1112046 | ENC1212046 | ENC1312046 | ENC1412046 | ENC1512046 | ENC1612046 | 547 € |
| 140x46 | ENC1014046 | ENC1114046 | ENC1214046 | ENC1314046 | ENC1414046 | ENC1514046 | ENC1614046 | 636 € |
| |  sanycoat En color RAL In RAL color De couleur RAL | | | | | | | |
| 70x46 | | | | | | | CE7046RAL | 413 € |
| 80x46 | * | | | | | | CE8046RAL | 444 € |
| 100x46 | * | | | | | | CE10046RAL | 548 € |
| 120x46 | * | | | | | | CE12046RAL | 656 € |
| 140x46 | * | | | | | | CE14046RAL | 764 € |

Los colores de las fotografías no son vinculantes, para una mejor identificación del color, consultar carta RAL o NCS.

The colors of the photographs are not binding, for a better identification of the color, consult RAL or NCS card.

Les couleurs des photos peuvent être légèrement différentes. Pour une meilleure identification de la couleur, consultez les nuanciers RAL o NCS.



ceramicvitreous





basins selection



Padova

ceramicvitreous

Ø39,5x14h



○ Blanco brillo
White gloss
Blanc brillant

○ Blanco mate
White matt
Blanc mat

● Negro brillo
Black gloss
Noir brillant

● Negro mate
Black matt
Noir mat

● Gris mate
Grey matt
Gris mat





 Padova white matt

Padova



 Padova white matt



 Padova white gloss



 Padova black matt



 Padova black gloss



 Padova grey matt



 Padova grey matt

Marsala

ceramicvitreous

Ø36,5x12h



○ Blanco brillo
White gloss
Blanc brillant

○ Blanco mate
White matt
Blanc mat

● Negro brillo
Black gloss
Noir brillant

● Negro mate
Black matt
Noir mat

● Gris mate
Grey matt
Gris mat



 Marsala white matt



Marsala





— Marsala grey matt

Marsala



 Marsala white gloss



 Marsala black gloss



 Marsala grey matt



 Marsala black matt



 Marsala white matt

Catania

ceramicvitreous

39x39x13,5h

50,5x40x13h



○ Blanco brillo
White gloss
Blanc brillant

○ Blanco mate
White matt
Blanc mat

● Negro mate
Black matt
Noir mat

● Gris mate
Grey matt
Gris mat



 Catania 50,5x40 white gloss

 Catania 39x39 white gloss



 Catania 50,5x40 white matt

Catania



 Catania 50,5x40 grey matt

 Catania 39x39 black matt

Trapani

ceramicvitreous

60x38x13,5h



○ Blanco brillo
White gloss
Blanc brillant

○ Blanco mate
White matt
Blanc mat

● Negro mate
Black matt
Noir mat

● Gris mate
Grey matt
Gris mat



 Trapani black matt



ceramicvitreous

Trapani white gloss

Modena

ceramicvitreous

32,5x45,8x14h



○ Blanco brillo
White gloss
Blanc brillant

○ Blanco mate
White matt
Blanc mat

● Negro mate
Black matt
Noir mat

● Gris mate
Grey matt
Gris mat



 Modena grey matt



 Modena black matt



ceramicvitreous

Modena white matt



project line



Palermo

ceramicvitreous

42,5x42,5x14,5h



○ Blanco brillo
White gloss
Blanc brillant





Marino

ceramicvitreous

50x38x12h



○ Blanco brillo
White gloss
Blanc brillant





Chiure

ceramicvitreous

Ø60x42x14,5h



○ Blanco brillo
White gloss
Blanc brillant





Pisa

ceramicvitreous

56x40x12,5h



○ Blanco brillo
White gloss
Blanc brillant





Napoli

ceramicvitreous

49,5x39,5x15h



○ Blanco brillo
White gloss
Blanc brillant





Lecce

ceramicvitreous

47,5x37x13h



○ Blanco brillo
White gloss
Blanc brillant





Verona

ceramicvitreous

56x36x14,5h



○ Blanco brillo
White gloss
Blanc brillant





Bergamo

ceramicvitreous

59x39x14h



○ Blanco brillo
White gloss
Blanc brillant





Cagliari

ceramicvitreous

37,5x37,5x13h



○ Blanco brillo
White gloss
Blanc brillant





Balta

ceramicvitreous

50,5x38,5x13,5h



○ Blanco brillo
White gloss
Blanc brillant





Parma

ceramicvitreous

52x39,5x13h



○ Blanco brillo
White gloss
Blanc brillant







XS basins



Petit

ceramicvitreous

40x22x11h

71,5x27,5x12h



○ Blanco brillo
White gloss
Blanc brillant

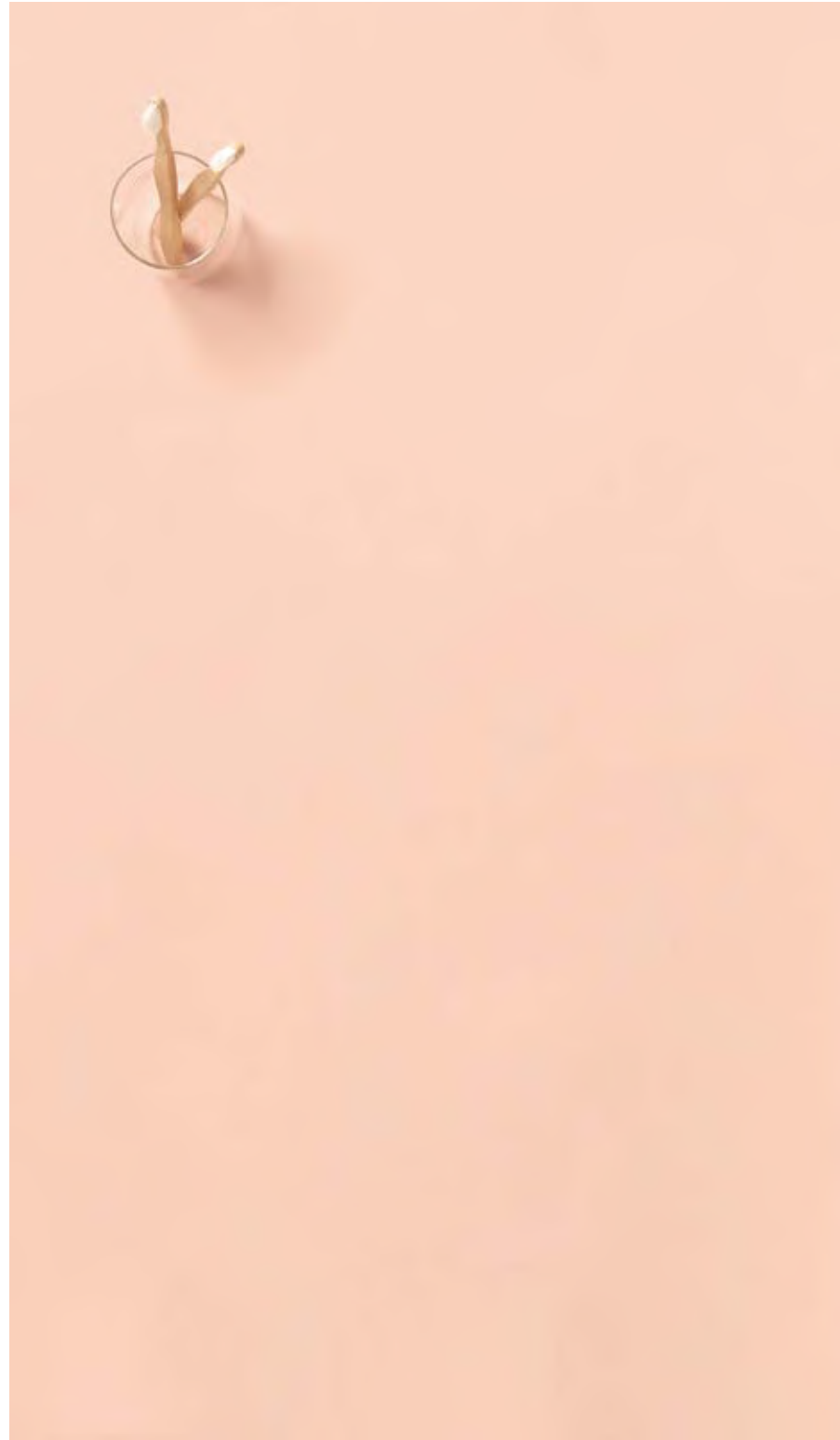



Petit





 Petit left 40x20

Mini

ceramicvitreous

40x20x10,5h



 Mini left



Mini left

Cosenza

ceramicvitreous

40x30x12h



○ Blanco brillo
White gloss
Blanc brillant





Padova

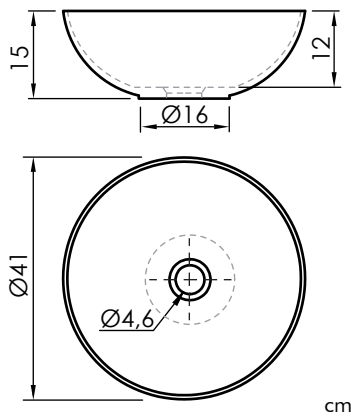

Marsala

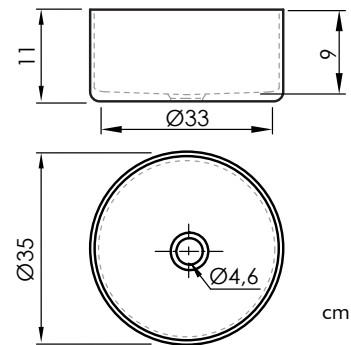

Lavabo / Washbasin / Vasque



Padova

| Blanco brillo White gloss Blanc brillant | Blanco mate White matt Blanc mat | Negro brillo Black gloss Noir brillant | Negro mate Black matt Noir mat | Gris mate Grey matt Gris mat |
|--|--|--|--------------------------------------|------------------------------------|
| LA500003 | LA500003BM | LA500003NB | LA500003NM | LA500003GM |
| 150 € | 230 € | 230 € | 230 € | 230 € |

Lavabo / Washbasin / Vasque



Marsala

| Blanco brillo White gloss Blanc brillant | Blanco mate White matt Blanc mat | Negro brillo Black gloss Noir brillant | Negro mate Black matt Noir mat | Gris mate Grey matt Gris mat |
|--|--|--|--------------------------------------|------------------------------------|
| LA500019BB | LA500019 | LA500019NB | LA500019N | LA500019GM |
| 160 € | 210 € | 210 € | 210 € | 210 € |

Accesorios / Accessories / Accessoires



Desagüe click-clack tapa cerámica
Pop-up ceramic waste
Bonde click-clack en céramique

| Blanco brillo White gloss Blanc brillant | Blanco mate White matt Blanc mat | Negro brillo Black gloss Noir brillant | Negro mate Black matt Noir mat | Gris mate Grey matt Gris mat |
|--|--|--|--------------------------------------|------------------------------------|
| ACCLV007BB | ACCLV007BM | ACCLV007NB | ACCLV007NM | ACCLV007GM |
| 65 € | 65 € | 65 € | 65 € | 65 € |

Catania

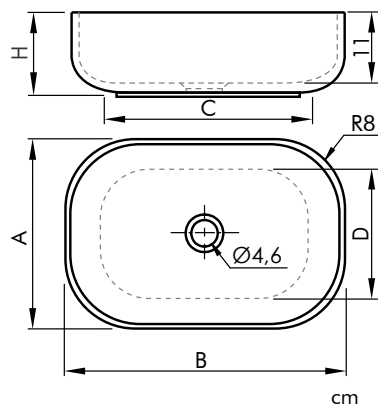

| dim.cm | A | B | C | D | H |
|---------|----|------|----|----|------|
| 39x39 | 39 | 39 | 32 | 32 | 13,5 |
| 50,5x40 | 40 | 50,5 | 43 | 31 | 13 |

Trapani

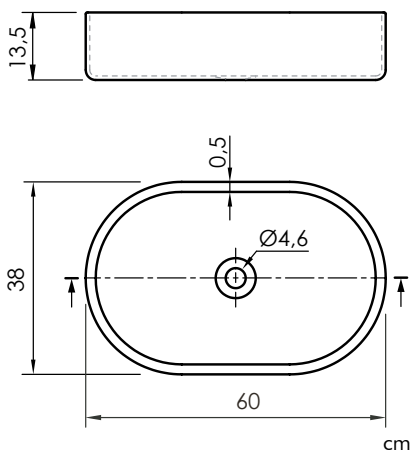

Modena

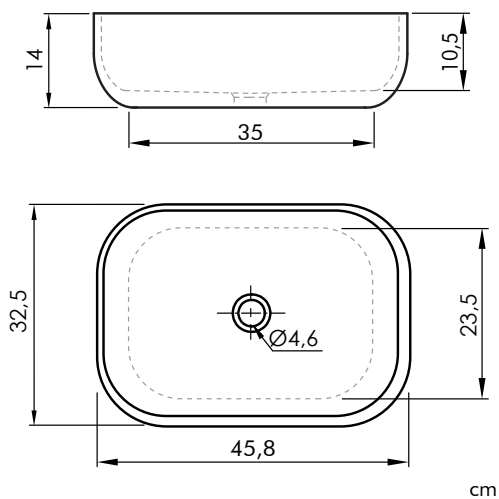

Lavabo / Washbasin / Vasque

| |  Blanco brillo White gloss Blanc brillant |  Blanco mate White matt Blanc mat |  Negro mate Black matt Noir mat |  Gris mate Grey matt Gris mat |
|--|---|---|---|---|
|  Catania 39x39 cm | LA500020BB 180 € | LA500020 250 € | LA500020N 250 € | LA500020GM 250 € |
|  Catania 50,5x40 cm | LA500018BB 190 € | LA500018 290 € | LA500018N 290 € | LA500018GM 290 € |

Lavabo / Washbasin / Vasque

| |  Blanco brillo White gloss Blanc brillant |  Blanco mate White matt Blanc mat |  Negro mate Black matt Noir mat |  Gris mate Grey matt Gris mat |
|---|---|---|---|---|
|  Trapani | LA500021B 200 € | LA500021 300 € | LA500021N 300 € | LA500021GM 300 € |

ceramicvitreous

Lavabo / Washbasin / Vasque

| |  Blanco brillo White gloss Blanc brillant |  Blanco mate White matt Blanc mat |  Negro mate Black matt Noir mat |  Gris mate Grey matt Gris mat |
|--|---|---|---|---|
|  Modena | LA500031BB 180 € | LA500031BM 280 € | LA500031NM 280 € | LA500031GM 280 € |

Accesorios / Accessories / Accessoires

| |  Blanco brillo White gloss Blanc brillant |  Blanco mate White matt Blanc mat |  Negro mate Black matt Noir mat |  Gris mate Grey matt Gris mat |
|---|---|---|---|---|
|  Desagüe click-clack tapa cerámica Pop-up ceramic waste Bonde click-clack en céramique | ACCLV007BB 65 € | ACCLV007BM 65 € | ACCLV007NM 65 € | ACCLV007GM 65 € |

Palermo

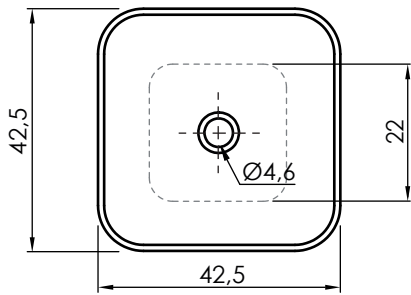
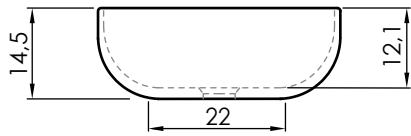

cm

Marino

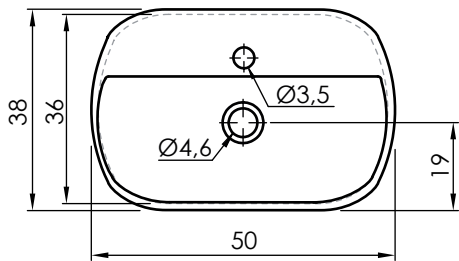
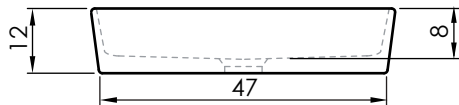

cm

Chiure

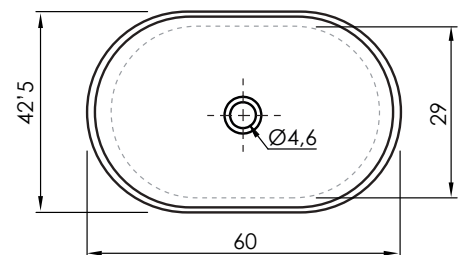
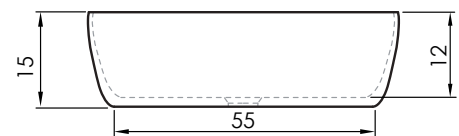

cm

Lavabo / Washbasin / Vasque



Blanco brillo / White gloss / Blanc brillant

LA500007

150 €



Palermo

Lavabo / Washbasin / Vasque



Blanco brillo / White gloss / Blanc brillant

LA500017

175 €



Marino

Lavabo / Washbasin / Vasque



Blanco brillo / White gloss / Blanc brillant

LA500015

180 €



Chiure

Accesorios / Accessories / Accessoires



Blanco brillo
White gloss
Blanc brillant

ACCLV007BB

65 €



Desagüe click-clack tapa cerámica
Pop-up ceramic waste
Bonde click-clack en céramique

Pisa

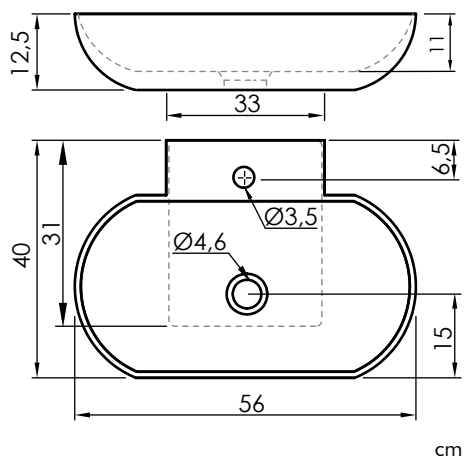

Napoli

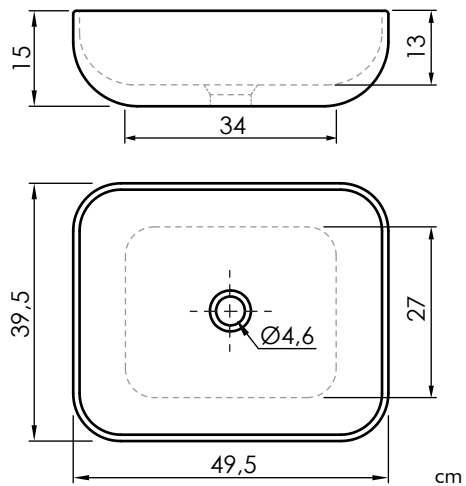

Lavabo / Washbasin / Vasque



Blanco brillo / White gloss / Blanc brillant

LA500004

160 €



Pisa

Lavabo / Washbasin / Vasque



Blanco brillo / White gloss / Blanc brillant

LA500008

162 €



Napoli

Accesorios / Accessories / Accessoires



Blanco brillo
White gloss
Blanc brillant

ACCLV007BB

65 €



Desagüe click-clack tapa cerámica
Pop-up ceramic waste
Bonde click-clack en céramique

Lecce

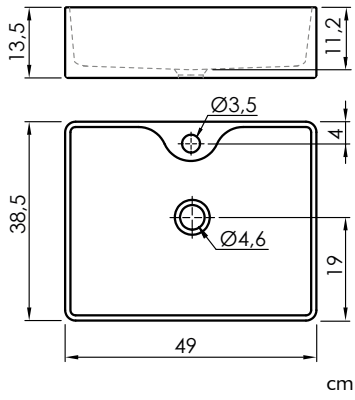

Verona

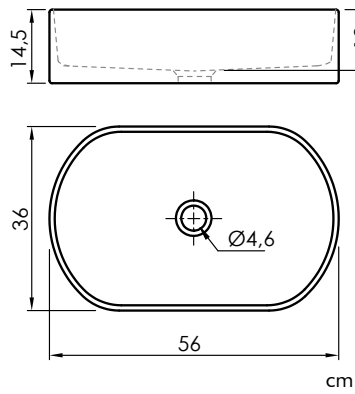

Bergamo

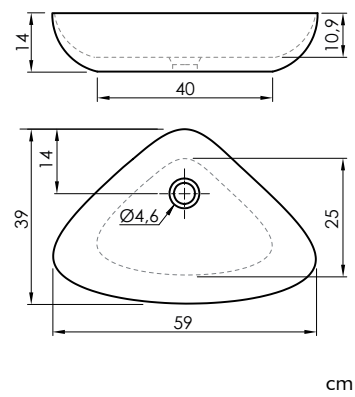

Lavabo / Washbasin / Vasque



Lecce



Blanco brillo / White gloss / Blanc brillant

LA500001

150 €

Lavabo / Washbasin / Vasque



Verona



Blanco brillo / White gloss / Blanc brillant

LA500006

161 €

ceramicvitreous

Lavabo / Washbasin / Vasque



Bergamo



Blanco brillo / White gloss / Blanc brillant

LA500005

160 €

Accesorios / Accessories / Accessoires



Desagüe click-clack tapa cerámica
Pop-up ceramic waste
Bonde click-clack en céramique



Blanco brillo
White gloss
Blanc brillant

ACCLV007BB

65 €

Cagliari

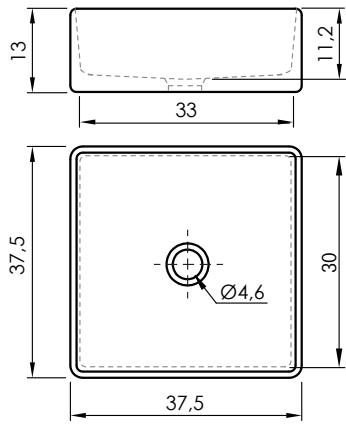

cm

Balta

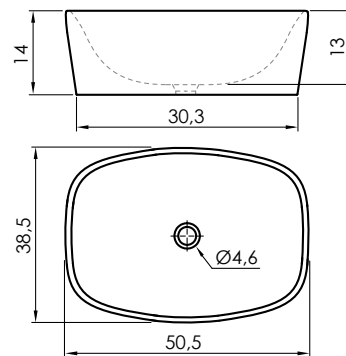

cm

Parma

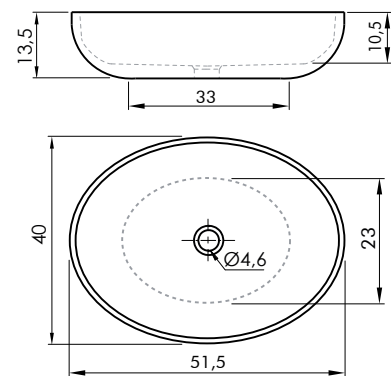

cm

Lavabo / Washbasin / Vasque



Cagliari



Blanco brillo / White gloss / Blanc brillant

LA500002

140 €

Lavabo / Washbasin / Vasque



Balta



Blanco brillo / White gloss / Blanc brillant

LA500023BB

200 €

ceramicvitreous

Lavabo / Washbasin / Vasque



Parma



Blanco brillo / White gloss / Blanc brillant

LA500030BB

165 €

Accesorios / Accessories / Accessoires



Desagüe click-clack tapa cerámica
Pop-up ceramic waste
Bonde click-clack en céramique



Blanco brillo
White gloss
Blanc brillant

ACCLV007BB

65 €

Petit



| dim.cm | A | B | C | D | E | F | H |
|-----------|------|------|----|------|-----|------|----|
| 40x22 | 22 | 40 | 30 | 18,5 | 7,5 | 17 | 11 |
| 71,5x27,5 | 27,5 | 71,5 | 47 | 23 | 8,5 | 25,5 | 12 |

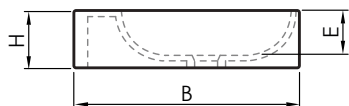

L: Izquierda / Left / Gauche

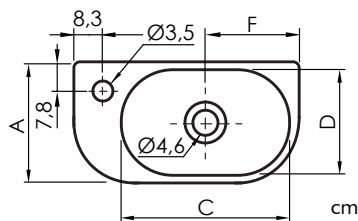

R: Derecha / Right / Droit

Mini

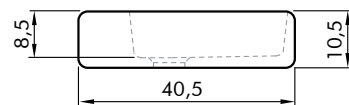

L: Izquierda / Left / Gauche

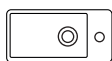
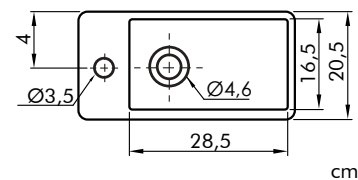

R: Derecha / Right / Droit

Cosenza

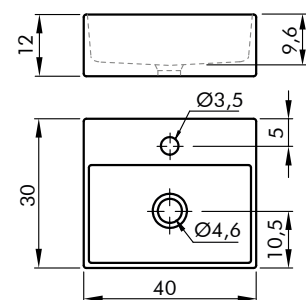

cm

Lavabo / Washbasin / Vasque



Blanco brillo / White gloss / Blanc brillant



Petit L 40x22cm

LA500024BB

125 €



Petit R 40x22cm

LA500025BB

125 €



Petit L 70x28cm

LA500026BB

205 €



Petit R 70x28cm

LA500027BB

205 €

Lavabo / Washbasin / Vasque



Blanco brillo / White gloss / Blanc brillant



Mini L 40x20cm

LA500028BB

122 €



Mini R 40x20cm

LA500029BB

122 €

Lavabo / Washbasin / Vasque



Blanco brillo / White gloss / Blanc brillant



Cosenza

LA500011

125 €

Accesorios / Accessories / Accessoires



Blanco brillo
White gloss
Blanc brillant



Desagüe click-clack tapa cerámica
Pop-up ceramic waste
Bonde click-clack en céramique

ACCLV007BB

65 €







natural wood surface



Zero





60-180x45-52



 Marsala white +  Zero Oak 160 x 45 +  ACCLV002  ENCMEC



Countertops

 Bol Ø41x15h+  Zero Walnut 60 x 52 +  Zero Walnut 140 x 52 +  ACCLV002  ENCMEC

Zero

naturalwood surface

60-180x45-52



 Zero Walnut



 Zero Oak

Encimeras de DM con acabado en chapa natural de roble o nogal americano.

Su proceso de fabricación contempla un lijado previo sobre la superficie de chapa, un sellado exhaustivo de poro y un acabado mega-mate que le confiere un aspecto natural y agradable al tacto.

En las encimeras Zero se pueden instalar toalleros de acero inoxidable lacados en blanco y negro mate.

MDF countertops finished in natural oak or American walnut veneer.

Its manufacturing process includes a previous sanding on the veneer surface, an exhaustive pore seal and a mega-matt finish that gives it a natural appearance so pleasant to the touch.

Zero countertops can be installed in black and white matt lacquered stainless steel towel racks.

Les comptoirs de MD, en finition chêne naturel ou en placage de noyer américain.

Son processus de fabrication comprend un ponçage préalable de la surface de la tôle, un joint de pores complet et une finition méga-mate qui lui donne un aspect naturel agréable au toucher.

Les comptoirs zéro peuvent être installés dans des porte-serviettes en acier inoxydable laqué mat noir et blanc



Zero

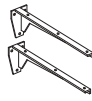
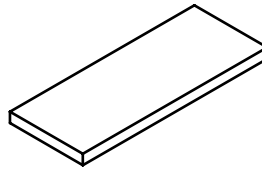
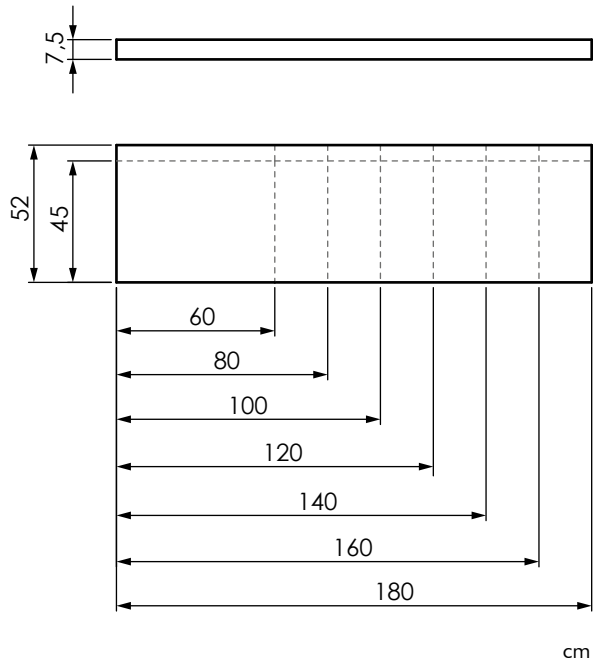

Componentes de instalación incluidos
Installation fittings included
Composants d'installation inclus.

Toallero frontal
Frontal towel rail
Porte-serviettes frontal

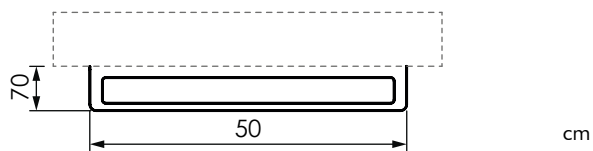

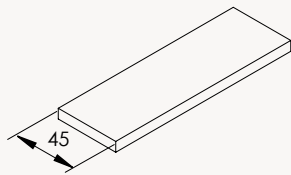

| | | | |
|-------------|-------------|-------------|-------|
| Zero 60x45 | ENC016045R | ENC016045N | 332 € |
| Zero 80x45 | ENC018045R | ENC018045N | 350 € |
| Zero 100x45 | ENC0110045R | ENC0110045N | 411 € |
| Zero 120x45 | ENC0112045R | ENC0112045N | 526 € |
| Zero 140x45 | ENC0114045R | ENC0114045N | 629 € |
| Zero 160x45 | ENC0116045R | ENC0116045N | 711 € |
| Zero 180x45 | ENC0118045R | ENC0118045N | 799 € |



| | | | |
|-----------------|------------|------------|----------|
| sanysize | ENC01SS45R | ENC01SS45N | 6 €/cm** |
|-----------------|------------|------------|----------|

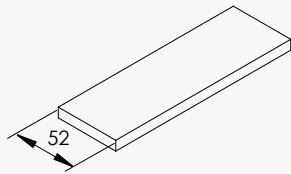

| | | | |
|-------------|-------------|-------------|-------|
| Zero 60x52 | ENC016052R | ENC016052N | 336 € |
| Zero 80x52 | ENC018052R | ENC018052N | 365 € |
| Zero 100x52 | ENC0110052R | ENC0110052N | 424 € |
| Zero 120x52 | ENC0112052R | ENC0112052N | 541 € |
| Zero 140x52 | ENC0114052R | ENC0114052N | 637 € |
| Zero 160x52 | ENC0116052R | ENC0116052N | 730 € |
| Zero 180x52 | ENC0118052R | ENC0118052N | 818 € |



| | | | |
|-----------------|------------|------------|-----------|
| sanysize | ENC01SS52R | ENC01SS52N | 7 €/cm*** |
|-----------------|------------|------------|-----------|

Options / Options / Options



| | | | |
|---|---|--------|------|
| Mecanizado para grifería o desagüe Tap and drain holes Robinet et drain trous | | ENCMEC | |
| | * | | 63 € |

Accesorios / Accessories / Accessoires



| | | | |
|--|--|-----------|-----------|
| Toallero frontal Frontal towel rail Porte-serviettes frontal | | ACCENC001 | ACCENC002 |
| | | 94 € | 94 € |

* Consulte los datos a aportar para un correcto mecanizado p.321
Para elegir lavabo consulte la tabla de compatibilidad, p.320
** Encimera con longitud a la medida (ancho 45 cm). Precio por centímetro lineal.
*** Encimera con longitud a la medida (ancho 52 cm). Precio por centímetro lineal.

* Consult the data to be provided for a correct machining p.321
To choose a washbasin, consult the compatibility chart, p.320
** Countertop with custom length (width 45 cm). Price per linear centimeter.
*** Countertop with custom length (width 52 cm). Price per linear centimeter.

* Consulter les données à fournir pour le perçage correct p.321
Pour choisir un lavabo, consultez le tableau de compatibilité, p.320
** Comptoir avec longueur sur mesure (largeur 45 cm). Prix par centimètre linéaire.
*** Comptoir avec longueur sur mesure (largeur 52 cm). Prix par centimètre linéaire.

Materials

Al final, toda la calidad es percibida
a través del material...

In the end, quality is perceived
through the material...

A la fin, toute la qualité est perçue à
travers de la matière...

sanycoat

Nuestros conceptos

Los recubrimientos sanycoat sobre productos Solid Sanycces® permiten personalizar el exterior del producto con colores fácilmente combinables entre sí. El recubrimiento es de alta resistencia apto para su uso en baños.

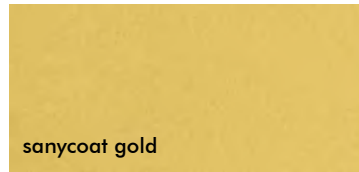

Los colores de las fotografías no son vinculantes, para una mejor identificación del color, consultar carta RAL o NCS.

Our concepts

Sanycoat coatings on Solid Sanycces® products allow to personalize the exterior of the product with colors easily combinable with each other. The coating is of high resistance suitable for use in bathrooms.

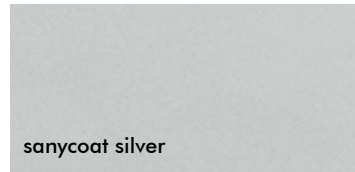

The colors of the photographs are not binding, for a better identification of the color, consult RAL or NCS card.

Nos concepts

Les revêtements sanycoat sur les produits Solid Sanycces® permettent de personnaliser l'extérieur du produit avec des couleurs facilement combinables. Le revêtement est de haute résistance adapté pour une utilisation dans les salles de bains

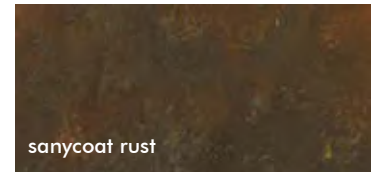

Les couleurs des photos peuvent être légèrement différentes. Pour une meilleure identification de la couleur, consultez les nuanciers RAL ou NCS.

customral customncs

Los productos con customral y customncs ofrecen la posibilidad de fabricarse con los colores de dichas cartas, convirtiéndose en grandes aliados para arquitectos, interioristas y decoradores.

Customral and customncs products offer the possibility of being manufactured with the colors of these letters, becoming great allies for architects, interior designers and decorators.

Les produits customral et customncs peuvent être fabriqués avec toutes les couleurs de ces nuanciers. Ils se constituent comme de grands alliés des architectes, interioristes, decorateurs

| | Nuestros conceptos | Our concepts | Nos concepts |
|-------------------------|--|--|---|
| Solid Sanycces® | Es nuestro material solid surface, consulte sus ventajas, propiedades y métodos de limpieza en las páginas siguientes. | Is our solid surface material, see its advantages, properties and cleaning methods in the following pages. | Notre matériel en solid surface (Surface solide), vérifiez ses avantages, propriétés et méthodes de nettoyage dans les pages suivantes |
| sanydur gel coat | Es un material compuesto por un núcleo de cargas minerales y resina y una superficie de gel coat sanitario. Consulte sus ventajas y métodos de limpieza en las páginas siguientes. | Is a material composed of a core of mineral fillers with resin and a surface of sanitary gel coat. See its advantages, properties and cleaning methods in the following pages. | Matériel composé d'un noyau de charges minérales et de résine et d'une surface de gel coat sanitaire. Voir ses avantages et méthodes de nettoyage dans les pages suivantes. |
| ceramicvitreous | Contamos con una amplia gama de lavabos de cerámica vitrificada, en acabados blanco y negro brillo y mate. Gris mate e incluso metalizados. | We have a wide range of vitrified ceramic washbasins, in gloss and matt black and white finishes. Matt grey and even metallic. | Nous disposons d'une large gamme de vasques en céramique vitrifiée, en finition noire et blanche, brillante et mate. Gris mat et même métallique. |

solid[®]

sanycces

A la vanguardia de los materiales compuestos, Solid Sanycces[®] es nuestro material solid surface. Esta familia de materiales ofrece al diseño un abanico ilimitado de posibilidades técnicas y estéticas. Su tacto sedoso y cálido junto con su apariencia mineral y su índice de reflexión de la luz lo convierten en un material capaz de transformar cualquier pieza en la protagonista del baño.

At the forefront of composite materials, Solid Sanycces[®] is our solid surface material. This family of materials offers to design an unlimited range of technical and aesthetic possibilities. Its silky and warm touch with its stone-like appearance and reflectivity of light make it a material capable of transforming any bathroom piece in protagonist.

A la pointe des matériaux composés, Solid Sanycces[®] est notre matière Solid Surface. Cette famille offre un éventail illimité de possibilités de conceptions techniques et esthétiques. Tant son apparence minérale comme son toucher soyeux et chaud et son indice de réflexion de la lumière le convertisse en un matériel capable de transformer n'importe quelle pièce en protagoniste de la salle de bain.



Desarrollado y producido completamente por y para Sanycces. La fórmula del Solid Sanycces®, fruto de una profunda investigación en materiales composites Solid Surface, es única.

Developed and produced entirely by and for Sanycces. The formula of Solid Sanycces® results of thorough research into Solid Surface composite materials, it is unique.

Développée et produite dans son intégralité par et pour Sanycces, la formule du Solid Sanycces®, résultat d'une intense recherche dans les matériaux composite Solid Surface, est unique.

Propiedades:

Properties:

Propriétés:

Fácil limpieza

Su superficie no porosa facilita la limpieza.



Easy cleaning

Its non-porous surface makes cleaning easy.

Nettoyage facile

Sa surface non poreuse facilite son nettoyage.

Agradable al tacto

Su superficie es suave y cálida.



Pleasant to the touch

Its surface is smooth and warm.

Agréable au toucher

Sa surface est douce et chaude.

Homogéneo

Material compacto y uniforme en todo su espesor.



Homogeneous

Compact and uniform material throughout its thickness.

Homogène

Matériel compacte et uniforme dans toute son épaisseur.

Color

Su color es estable.



Color

Its color is stable.

Couleur

Sa couleur est stable.

Resistente a químicos.

Su exclusiva formulación lo hace resistente a productos de limpieza de uso habitual en el baño.



Chemical Resistant

Its unique formulation makes it resistant to cleaning agents commonly used in the bathroom.

Résistant aux produits chimiques.

Sa formule exclusive lui permet de résister aux produits de nettoyage habituels de salle de bain.

Higiénico

Su composición y no porosidad resulta en un material altamente higiénico.



Hygienic

Its composition without porosity turns in a highly hygienic material.

Hygienne

Sa composition et sa surface non poreuse en fait de lui un matériel hautement hygienique.

Sansize

Permite el corte a medida y configuraciones especiales.



Sansize

It allows cutting to size and Special configurations.

Sansize

Il permet la découpe sur mesure et les configurations spéciales.

Sanycoat

Permite tratamientos cromáticos y texturizados.



Sanycoat

Allows chromatic treatments and textured.

Sanycoat

Il permet les traitements chromatiques et de texture.

Recuperable

Su superficie permite recuperar el aspecto del primer día con el uso de esponjas abrasivas suaves.



Renewable

Its surface allows recovering the appearance of the first day with the use of soft-abrasive sponges.

Récupérable

Sa surface permet de récupérer l'aspect du premier jour grâce à l'utilisation d'éponges abrasives douces.

Reparable

Pequeños accidentes en la superficie pueden restaurarse.



Reparable

Scratches or small accidents on the surface can be restored.

Réparable

Les petits incidents en surface peuvent se récupérer.

Alta dureza

Las cargas minerales aportan una elevada dureza y resistencia al desgaste haciendo la superficie duradera.



High hardness

Mineral fillers provide high hardness and wear resistance making a long-lasting surface.

Haute solidité

Les charges minérales apportent un indice élevé de solidité et résistance à l'usure créant une surface longévive.

Technical characteristics

Las características mecánicas y físicas de Solid Sanycces® así como su idoneidad para la fabricación de equipamiento para el baño han sido testeadas bajo los más rigurosos estándares europeos e internacionales.

The mechanical and physical Solid Sanycces® features, as well as its suitability for the manufacture of bathroom equipment have been tested under the most stringent European and International standards.

Les caractéristiques mécaniques et physiques de Solid Sanycces® ainsi que son adéquation à la fabrication d'équipements pour la salle de bain ont été testées suivant les standards européens et internationaux les plus rigoureux.

| Property | Standard | Test Method | Result | Units | Requirement |
|--|----------------------------------|---|--|--|--|
| Densidad Density Densité | DIN ISO 1183-1 | Inmersión Immersion Immersion | 1,927 | g/cm3 | - |
| Resistencia al impacto Impact resistance Résistance aux chocs | ISO 19712 | Bola (324g 0,61m) Large ball (324g 0,61m) Grosse boule (324g 0,61m) | | - | Sin roturas ni desconches No breaks or chips Aucune fissure ou écaillage |
| Dureza superficial Hardness Dureté | UNE 53270 | Bárcol | 65 | Escala bárcol Barcol scale échelle Barcol | - |
| Resistencia a la abrasión Abrasion resistance Résistance à l'abrasion | ISO 5470-1 | - | 166 | mg/100 cycles | - |
| Resistencia al choque térmico (65-10°C) Thermal shock resistance (65-10°C) Résistance aux chocs thermiques (65-10°C) | ISO 19712-3 | B (500 cycles) | | - | Sin roturas ni desconches No breaks or chips Aucune fissure ou écaillage |
| Resistencia al calor húmedo Resistance to wet heat Résistance à la chaleur humide | ISO 19712-3 | A | 5 (sin cambios visibles) 5 (no visible changes) 5 (aucun changement visible) | Escala cualitativa (1-5) Qualitative scale (1-5) échelle qualitative (1-5) | >3 (ligeros cambios en brillo y/o color) >3 (Slight changes in brightness and / or color) >3 (De légères variations de luminosité et / ou couleur) |
| Resistencia a químicos y manchas Resistance to chemicals and stains Résistance chimique et aux taches | ISO 19712-3 | A | 5 (sin cambios visibles) 5 (no visible changes) 5 (aucun changement visible) | Escala cualitativa (1-5) Qualitative scale (1-5) échelle qualitative (1-5) | >3 (ligeros cambios en brillo y/o color) >3 (Slight changes in brightness and / or color) >3 (De légères variations de luminosité et / ou couleur) |
| Resistencia a la quemadura del cigarrillo Cigarette burn resistance Résistance à la brûlure de cigarette | ISO 19712-3 | A | 5 (sin cambios visibles) 5 (no visible changes) 5 (aucun changement visible) | Escala cualitativa (1-5) Qualitative scale (1-5) échelle qualitative (1-5) | >3 (ligeros cambios en brillo y/o color) >3 (Slight changes in brightness and / or color) >3 (De légères variations de luminosité et / ou couleur) |
| Solidez del color a la luz Lightfastness Solide couleur à la lumière | ISO 19712-3 | A | 4,5-5 (muy buena) 4,5-5 (very good) 4,5-5 (très bonne) | Escala de grises (1-5) Grey scale (1-5) Niveaux de gris (1-5) | 4-5 (de buena a excelente) 4-5 (From good to excellent) 4-5 (Bon à excellent) |
| Test superficial Surface test Test de surface | ISO 19712-3 | | 0,7 | mm2 | Superficie afectada max 1mm2/m2 Affected area Max 1mm2 / m2 Zone touchée max 1mm2 / m2 |
| Conformidad marcado CE CE marking conformity Conformité marquage CE | EN 14527 EN 14688 EN 14516 | | | - | |

Chemical resistance and cleaning

Nuestra preocupación por el comportamiento del material va más allá de los requisitos normativos basados en tests estandarizados. Conocemos lo que ocurre en condiciones de uso y mantenimiento habituales y definimos los siguientes protocolos de limpieza para que su producto en Solid Sanycces® luzca como el primer día.

Our concern for the material behaviour goes beyond bathroom regulatory requirements based on standardized tests. We know what happens in the Terms of regular use and maintenance, and define the following cleaning protocols so that your product in Solid Sanycces® looks like the first day.

Notre constante préoccupation pour le comportement du matériel va au-delà des normes requises basées sur des tests standardisés. Connaisseurs de son devenir suivant des conditions d'utilisation et de maintenance habituelles, nous définissons les protocoles suivants de nettoyage afin que votre produit en Solid Sanycces® reste comme au premier jour.

| Agents | Cleaning method | Agents | Cleaning method |
|---|-----------------|---|-----------------|
| Aguarrás Turpentine White spirit | 1 | Limpiador multiusos Multipurpose cleaner Gel nettoyant multi tâches | 2 |
| Acetona Acetone Acétone | 3 | Betadine Betadine (Type mercure au chrome) | 4 |
| Disolvente universal Universal solvent Dissolvant universel | 1 | Peróxido de hidrógeno Hydrogen peroxide Eau oxygénée | 1 |
| Alcohol metílico Methylated Spirits Alcool méthylique | 1 | Alcohol Etilico 96° Ethyl alcohol 96° Alcool éthylique 96° | 1 |
| Lejía Bleach Eau de javel | 4 | Tinte para cabello Hair colour Coloration capillaire | 5 |
| Amoniaco Ammonia Ammoniac | 2 | Esmalte de uñas Nail Polish Vernis à ongles | 6 |
| Ácido clorhídrico Hydrochloric acid acide chlorhydrique | 3 | Maquillaje Make up Maquillage | 4 |
| Desatacadór doméstico Domestic Toilet plunger Déboucheur domestique | 4 | Betún calzado Shoe Polish Cirage à chaussures | 4 |
| Cillit BANG | 2 | Rotulador permanente Permanent marker Marqueur permanent | 7 |
| Vinagre Vinegar Vinaigre | 2 | Limón Lemon Citron | 2 |
| Limpiador de WC WC cleaner Liquide nettoyant de WC | 2 | Café Coffee Café | 5 |
| Quitamanchas Stain remover Anti-tâches | 1 | Vino tinto Red wine Vin rouge | 5 |

1. Retirar con un trapo seco.

2. Aclarar con agua.

3. Esponja de fibra blanca.

4. Esponja de fibra blanca + limpiador en crema abrasivo.

5. Esponja de fibra verde + limpiador en crema abrasivo.

6. Eliminar con quitaesmalte de uñas.

7. Eliminar con alcohol.

1. Remove with dry cloth.

2. Rinse with water.

3. White fiber scrubber.

4. White fiber scrubber + abrasive creamy cleaner.

5. Green fiber scrubber + abrasive creamy cleaner.

6. Remove with nail polish remover.

7. Remove with alcohol.

1. Enlever à l'aide d'un linge sec.

2. Rincer à l'eau.

3. Éponge à récurer de fibres blanches

4. Éponge à récurer de fibres blanches + gel nettoyant en crème avec agent abrasif.

5. Éponge à récurer de fibres vertes + gel nettoyant en crème avec agent abrasif.

6. Enlever à l'aide de dissolvant.

7. Enlever avec alcool méthylique.

sanydur gel coat

Sanydur gel coat es un material compuesto por un núcleo de cargas minerales y resina y una superficie de gel coat que le concede propiedades sanitarias a los productos fabricados con este material.

Sanydur gel coat is a material composed of a core of mineral fillers and resin and a gel coat surface that brings sanitary properties to the products made with this material.

Sanydur gel coat est un matériau composé d'un noyau de charges minérales et de résine et d'une surface de revêtement de gel qui confère des propriétés sanitaires aux produits fabriqués avec ce matériau.

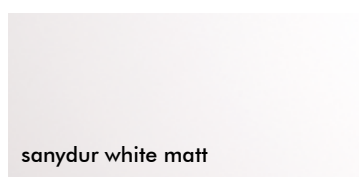

Los colores de las fotografías no son vinculantes, para una mejor identificación del color, consultar carta RAL o NCS.

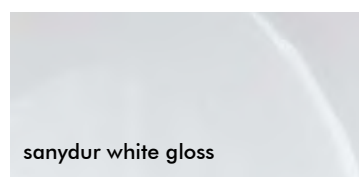

The colors of the photographs are not binding, for a better identification of the color, consult RAL or NCS card.

Les couleurs des photos peuvent être légèrement différentes. Pour une meilleure identification de la couleur, consultez les nuanciers RAL ou NCS.

| | Propiedades: | Properties: | Propriétés: |
|---|---|---|--|
|  | Fácil limpieza Su superficie no porosa facilita la limpieza. | Easy cleaning Its non-porous surface makes cleaning easy. | Nettoyage facile Sa surface non poreuse facilite son nettoyage. |
|  | Agradable al tacto Su superficie es suave y cálida. | Pleasant to the touch Its surface is smooth and warm. | Agréable au toucher Sa surface est douce et chaude. |
|  | Color Su color es estable. | Color Its color is stable. | Couleur Sa couleur est stable. |
|  | Resistente a químicos Su exclusiva formulación lo hace resistente a productos de limpieza de uso habitual en el baño. | Chemical resistant Its unique formulation makes it resistant to cleaning agents commonly used in the bathroom. | Résistant aux produits chimiques Sa formule exclusive lui permet de résister aux produits de nettoyage habituels de salle de bain. |
|  | Higiénico Su composición y no porosidad resulta en un material altamente higiénico. | Hygienic Its composition without porosity turns in a highly hygienic material. | Hygienne Sa composition et sa surface non poreuse en fait de lui un matériel hautement hygiénique. |
|  | Reparable Pequeños accidentes en la superficie pueden restaurarse. | Reparable Scratches or small accidents on the surface can be restored. | Réparable Les petits incidents en surface peuvent se récupérer. |
|  | Alta dureza Las cargas minerales aportan una elevada dureza y resistencia al desgaste haciendo la superficie duradera. | High hardness Mineral fillers provide high hardness and wear resistance making a long-lasting surface. | Haute solidité Les charges minérales apportent un indice élevé de solidité et résistance à l'usure créant une surface longévive. |
|  | Antideslizante La textura pizarra está clasificada como clase 3 conforme al CTE (código técnico de la edificación y ensayo ENV12633). | Antislip Slate texture is classified as class 3 according to the CTE (spanish technical code for building and test ENV12633). | Antidérapant La texture de l'ardoise est classée en classe 3 selon le CTE (code technique du bâtiment espagnol et test ENV12633). |
|  | Garantía Los platos de ducha fabricados con sanydur gel coat y sanylite gel coat tienen una garantía de 5 años. | Warranty Shower trays made with sanydur gel coat and sanylite gel coat have a 5 year warranty. | Garantie Les plateaux de douche fabriqués avec sanydur gel coat et sanylite gel coat bénéficient d'une garantie de 5 ans. |

sanydur gel coat

Definimos los siguientes protocolos de limpieza para que su producto en sanydur gel coat y sanylite gel coat luzcan como el primer día.

We define the following cleaning protocols so that your product in sanydur gel coat and sanylite gel coat look like the first day.

Nous définissons les protocoles suivants de nettoyage afin que votre produit en sanydur gel coat et sanylite gel coat reste comme au premier jour.

| Agents | Cleaning method | Agents | Cleaning method |
|---|-----------------|---|-----------------|
| Aguarrás Turpentine White spirit | 1 | Limpiador multiusos Multipurpose cleaner Gel nettoyant multi tâches | 2 |
| Acetona Acetone Acétone | 2 | Betadine Betadine (Type mercure au chrome) | 3 |
| Disolvente universal Universal solvent Dissolvant universel | 1 | Peróxido de hidrógeno Hydrogen peroxide Eau oxygénée | 2 |
| Alcohol metílico Methylated Spirits Alcool méthylique | 1 | Alcohol Etilico 96° Ethyl alcohol 96° Alcool éthylique 96° | 2 |
| Lejía Bleach Eau de javel | 2 | Tinte para cabello Hair colour Coloration capillaire | 4 |
| Amoniaco Ammonia Ammoniac | 2 | Esmalte de uñas Nail Polish Vernis à ongles | 6 |
| Ácido clorhídrico Hydrochloric acid acide chlorhydrique | 2 | Maquillaje Make up Maquillage | 4 |
| Desatacadador doméstico Domestic Toilet plunger Déboucheur domestique | 2 | Betún calzado Shoe Polish Cirage à chaussures | 4 |
| Cillit BANG | 2 | Rotulador permanente Permanent marker Marqueur permanent | 7 |
| Vinagre Vinegar Vinaigre | 2 | Limón Lemon Citron | 2 |
| Limpiador de WC WC cleaner Liquide nettoyant de WC | 2 | Café Coffee Café | 5 |
| Quitamanchas Stain remover Anti-tâches | 1 | Vino tinto Red wine Vin rouge | 4 |

1. Retirar con un trapo seco.
2. Aclarar con agua.
3. Aclarar con lejía en gel.
4. Esponja de fibra blanca + lejía.
5. Esponja de fibra verde + limpiador en crema abrasivo.
6. Eliminar con quitaesmalte de uñas.
7. Eliminar con alcohol.

1. Remove with dry cloth.
2. Rinse with water.
3. Rinse with bleach in gel.
4. White fiber scrubber + bleach.
5. Green fiber scrubber + abrasive creamy cleaner.
6. Remove with nail polish remover.
7. Remove with alcohol.

1. Enlever à l'aide d'un linge sec.
2. Rincer à l'eau.
3. Rincer avec de l'eau de javel en gel.
4. Éponge à récurer de fibres blanches + eau de Javel.
5. Éponge à récurer de fibres vertes + gel nettoyant en crème avec agent abrasif.
6. Enlever à l'aide de dissolvant.
7. Enlever avec alcool méthylique.

ceramicvitreous



La cerámica vitrificada es el material más conocido y más empleado a nivel global en el sector sanitario. Consiste en un cuerpo cerámico (compuesto por arcillas, caolines y otros elementos minerales) que se cubre de un esmalte a base de cristal que se vitrifica sobre la superficie al aplicar gran cantidad de calor.

- Fácil limpieza.
- Gran dureza y resistencia.
- Alto brillo.
- Estable con la temperatura.
- Resistencia a químicos.

The vitrified ceramic is the best known and most globally widely used in the bathroom equipment sector. It consists of a ceramic body (composed by clay, kaolin and other mineral components) that is covered by an enamel based on glass which is vitrified on the surface by applying a large amount of heat.

- Easy cleaning.
- High hardness and resistance.
- High gloss.
- Stable with temperature.
- Resistance to chemicals.

La céramique vitrifiée est un des matériaux des plus connus et le plus largement utilisé à niveau global dans le secteur sanitaire. Il se compose d'un corps en céramique (constitué par l'argile, le kaolin et d'autres minéraux) qui est recouvert d'un verre d'émail qui est vitrifié sur la surface en appliquant de grandes quantités de chaleur.

- Nettoyage facile.
- Haute dureté et résistance.
- Haute luminosité.
- Stable en température.
- Haute résistance chimique.

Natural wood finish



El aire fresco que respiran nuestros muebles proviene de maderas naturales, como son el roble y el nogal. Su acabado mate interactúa con la luz proporcionando una calidez que responde a su suave tacto.

The fresh air breathed in our furniture comes from its natural veneer surface, such as oak and walnut. Its matt finish interacts with the light providing a warmth whose soft touch corresponds.

Nos meubles respirent l'air frais qui provient de sa surface naturelle, soit le chêne et le noyer. Sa finition mate interagit avec la lumière, fournissant une chaleur et un tacte doux.

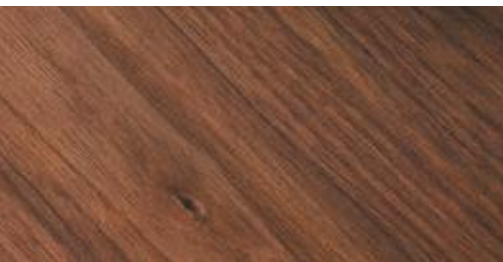

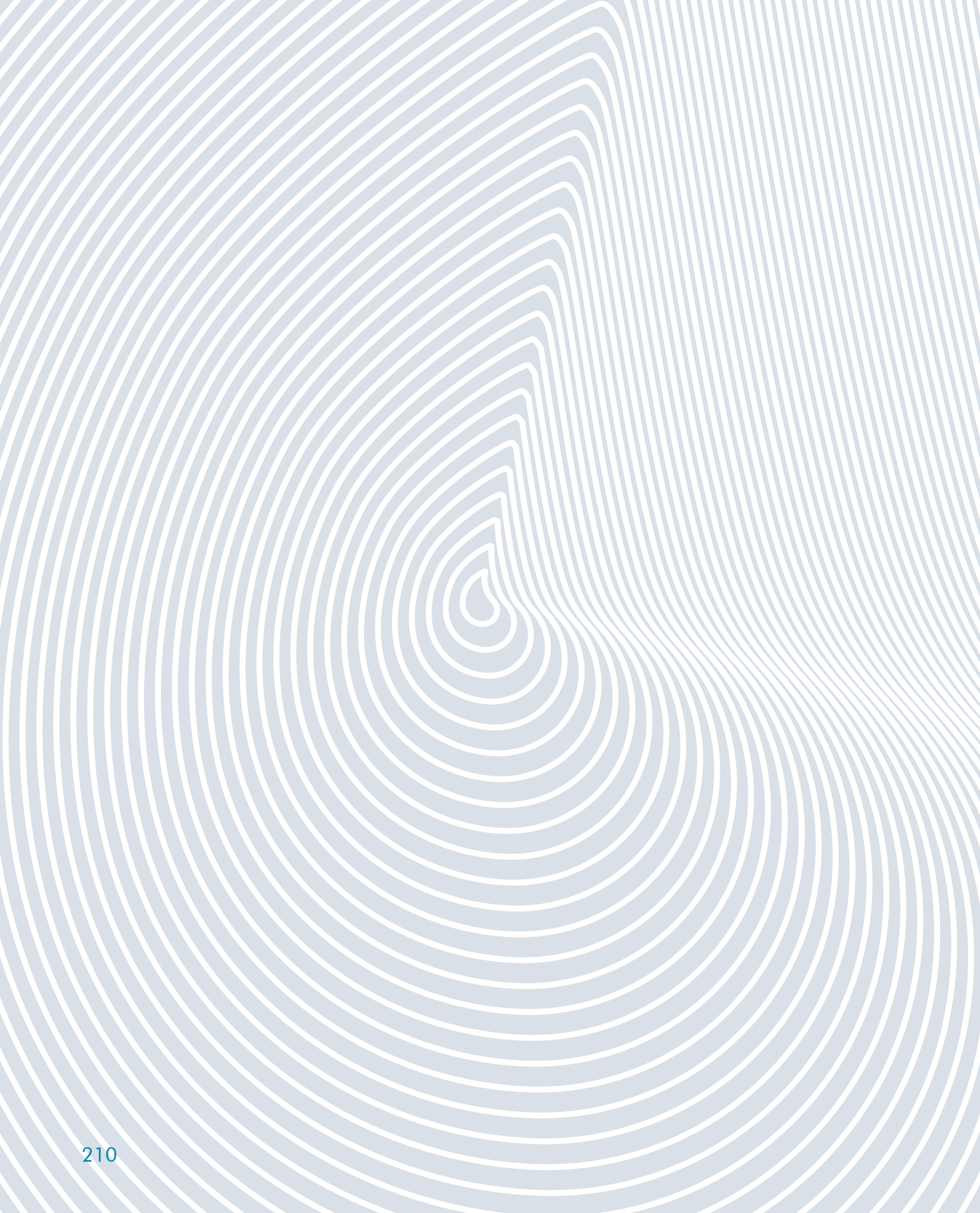

General info

Información general

Informations générales

GARANTÍA

Los productos Sanycces® están garantizados según la normativa europea vigente. Dicha garantía comprende los tres años siguientes a partir de la fecha de factura del producto emitida por Sanycces. Se considerarán válidas aquellas reclamaciones que sean realizadas por escrito. La garantía cubre los defectos de fabricación. La garantía no cubre deterioros no imputables al producto, materiales consumibles que pierden su efectividad con el uso, defectos derivados de negligencia en su manipulación, defectos derivados de la presión del agua excesiva en la red, al igual que los cuerpos extraños en el agua. Sanycces asume la garantía de sus productos, quedando entendido y expresamente convenido que dicha garantía se limitará a la sustitución de los productos que resultasen defectuosos por fabricación, con exclusión de cualquier otra compensación, daños o interés.

MATERIAL EXPOSICIÓN

Todo el material con destino a la exposición y precios especiales, tiene que mantenerse en exposición mínimo 12 meses, de no ser así, se procedería a emitir una nueva factura por el diferencial entre el descuento habitual del cliente y el que se le haya concedido por descuento especial para exposición.

CONDICIONES GENERALES

Los embalajes están incluidos en los precios.

En exportación, si su pedido no llega al valor mínimo pactado en sus condiciones de trabajo. Se le facturarán los portes indicados en las mismas.

COBERTURA DE RIESGO

Serán aceptados sólo aquellos pedidos que queden cubiertos por la compañía de riesgo con la que estamos operando. Para los pedidos, que no amparados por la compañía de aseguradora, deberán ofrecerse otras medidas de pago garantizado.

PEDIDOS

Todos los pedidos deberán cursarse siempre por escrito, bien por fax o correo electrónico y en caso de cursarse por teléfono, deberán confirmarse por cualquiera de los medios citados. Los pedidos se considerarán en firme desde el primer momento de su recepción, no admitiéndose posibles cambios, modificaciones posteriores ni anulaciones.

Los descuentos que deban aplicarse a las ventas de nuestros productos

se efectuarán según las condiciones pactadas con el cliente.

DEVOLUCIONES

Transcurridas 24 horas desde que el pedido se recibió en Sanycces, no se admitirán anulaciones. Una vez suministrado el pedido, no se admitirán devoluciones. En el caso de que se aceptara alguna devolución, se aplicaría una quita del 15 % sobre el valor de la mercancía. Rogamos revisen el material a su entrega. No se admitirán devoluciones sobre el material que haya sido instalado. Por roturas. La mercancía que se envía por transporte ordinario viaja asegurada, por lo que en caso de reclamación por roturas esta deberá hacerse antes de las 24 horas siguientes a la recepción de la misma. En caso de que no puede revisar la mercancía en el momento de la entrega realizada por el transportista se deberá hacer constar en el albarán de entrega del transporte pendiente de revisión. En caso de que el cliente verifique la rotura fuera de plazo, deberá ponerse en contacto con su representante al objeto de subsanar la incidencia producida. De todas formas insistimos en hacer hincapié de que revise todo el material a la recepción del

ASISTENCIA TÉCNICA Y POSTVENTA

Una red de asistencia técnica distribuida por todo el territorio nacional y portugués les garantiza la tranquilidad de tener siempre cerca un profesional de Sanycces.

Nuestro estricto control de calidad hace que confiemos en lo que ofrecemos. Aún así y completando nuestra garantía, ponemos a su disposición nuestro propio servicio de asistencia postventa donde encontrará un gran equipo de profesionales dispuesto a ayudarle, informarle y solucionar cualquier incidencia que tenga.

La estratégica situación de nuestras bases de asistencia postventa nos permite una ágil y rápida respuesta coordinada desde nuestras oficinas centrales. Disponemos de todos los medios necesarios para hacerle llegar nuestros productos en las mejores condiciones. Con el fin de facilitarles la atención a sus consultas y necesidades con la mayor agilidad posible, hemos incluido en nuestro servicio postventa una dirección de correo electrónico y un número exclusivo:

postventa@sanycces.es

Tel. (+34) 964 51 82 02

NOTA: Sanycces, S.L. se reserva el derecho de cambiar, alterar o retirar cualquier producto o componentes del mismo sin previo aviso. Estar en posesión de nuestro Catálogo o Tarifa no otorga el derecho a compra de ninguno de nuestros productos.

NOTA: Los colores de las fotografías no son vinculantes, para una mejor identificación del color, consultar carta RAL o NCS.

NORMAS

Y CERTIFICACIONES

- Lavabos
UNE-EN 14688

WARRANTY

Sanycces® products are guaranteed under existing European legislation. This guarantee covers the following three years from the Sanycces invoice date of the product. Will be considered valid those claims that are made in writing. The guarantee covers manufacturing defects. The warranty does not cover damage not attributable to the product. Consumible parts, products which cease to function through use, damage attributable to negligence handling, damage attributable to excessive water pressure in the water network as well as foreign bodies in the water.

Sanycces assumes the warranty of its products, being expressly understood and agreed that such warranty is limited to replacement of the products that were defective in manufacture, and no other compensation, damages or interest.

SHOWROOM PRODUCTS

All material destined for the showroom with special prices, has to be kept minimum 12 months in the showroom, otherwise, would proceed to issue a new invoice for the difference between the regular customer discount and the discount which has been granted by special discount for showroom.

GENERAL CONDITIONS

The packages are included in the prices.

For export, if your order does not reach the minimum value agreed in your conditions of work. You will be invoiced for the shipping costs indicated in the terms and conditions.

RISK COVERAGE COMPANY

Will only be accepted those which are covered by the risk coverage company with which we operate. Orders not underwritten by the insurance company must offer other guaranteed means of payment.

ORDERS

All orders should be made whenever writing or by fax or e-mail, and if filled by telephone, must be confirmed by any of the means listed. Orders are considered firm at the outset of their receipt, not admitting possible changes, posterior modifications or cancellations. The discounts to be applied to sales of our products are made in accordance with the set conditions agreed with the customer.

RETURNS

No devolution will be accepted after 24 hours since the material was received by the customer. In the case in which a devolution was accepted, a 15% on the value of the material would be paid by the customer. Please, we beg you revise the material the day you receive it. No devolutions will be accepted on the already installed material.

For breakage. The merchandise that travels by regular transportation is insured, so if there is a claim for breakage must be made within 24 hours after receipt thereof. If you can not inspect the goods at the time of delivery by the carrier must be recorded in the transport delivery order pending review. If the client verifies the breaking out of time, should contact their representative in order to overcome the impact produced. However we insist that all the material to check the receipt.

TECHNICAL ASSISTANCE AND POST SALE

A network of technical assistance distributed throughout the country and Portugal guarantees you the safety of always having near a professional of Sanycces. Our strict quality control means that we trust what we offer. Even so, and completing our guarantee, we offer our own after-sales service for assistance to find a great team of professionals willing to help, inform and solve any incidence you may have.

The strategic position of our after-sales assistance bases, enables us to a fast and coordinated response from our headquarters. We have all the necessary means to convey to you our products in the best possible conditions.

In order to provide care to their queries and needs with the greatest flexibility the possible, we have included in our after-sales service an e-mail address and an exclusive telephone number:

postventa@sanycces.es

Int. (+34) 964 51 82 02

NOTE: Sanycces, S.L. The manufacturer reserves the right to change, alter or withdraw any products or components thereof without previous notice. Possessing our catalog or price list does not give the right to purchase any of our products.

NOTE: The manufacturer recalls the obligation to put panels or registers to access to the devices inside the bathtub. In Acrylic materials measures are approximate and may vary. Dimensional tolerances ± 5 mm. Measures for the placement of the faucets are indicative.

NOTE: The colors of the photographs are not binding, for a better identification of the color, consult RAL or NCS card.

STANDARDS AND CERTIFICATIONS:

- Washbasins:
UNE-EN 14688

GARANTIES

Les produits Sanycces® sont garantis selon la législation européenne en vigueur. La garantie débute à la date de facture du produit émise par Sanycces, commandé et la période de validité est 3 ans. Seules les réclamations écrites seront prises en compte. Les garanties couvrent les défauts de fabrication. La garantie ne couvre pas les dommages non attribuables au produit, le renouvellement des produits qui perdent leurs fonctionnalités avec l'usage, sont les appelés consommables, les défauts consécutifs à une utilisation anormale du produit, les défauts consécutifs à une pression d'eau excessive du réseau ou à la présence de corps étrangers dans l'eau.

Sanycces garantit ses produits, étant sous entendu et expressément convenu que cette garantie couvre uniquement le remplacement des produits qui présentent des défauts de fabrication, et exclut toute autre indemnisation, dommages et intérêts.

PRODUITS POUR EXPOSITIONS

Tout le matériel qui sera destiné pour expositions et prix spéciaux, doit rester en exposition durant au moins 12 mois, dans le cas contraire, on devra refacturer entre la remise habituelle du client et la remise spéciale faite pour l'exposition.

CONDITIONS GÉNÉRALES DE VENTE

Les frais d'emballages sont inclus. Pour l'exportation, si votre commande n'atteint pas la valeur minimale convenue dans vos conditions de travail. Les frais d'expédition indiqués dans les conditions générales vous seront facturés.

RECOUVREMENT

Seules les commandes couvertes par notre société de recouvrement seront acceptées. Pour les commandes non couvertes par notre société de recouvrement, une garantie alternative de paiement devra être donnée.

COMMANDES

Les commandes doivent nous être adressées soit par fax ou par e-mail. Si la commande a été effectuée par téléphone, elle devra obligatoirement faire l'objet d'une confirmation écrite par fax ou e-mail afin d'éviter tout problème d'interprétation de quantités, références et prix. Les commandes sont considérées comme fermes et définitives dès réception, et aucune modification, total ou partielle, ou annulation ne sera acceptée. Toute remise applicable sur le montant de nos produits sera

établie selon les accords pactes au préalable avec le client.

RETOURS

Passé un délai de 24 heures après réception de la commande chez Sanycces, aucune annulation ne sera acceptée. Aucun retour de marchandise ne sera accepté une fois la commande livrée. En cas d'acceptation de retour d'une marchandise, le matériel retourné sera crédité sur la base de 85% du prix initial.

Important: Merci de bien vouloir vérifier le produit acheté à sa réception. Aucun retour ne sera admis sur un produit installé. Casse. La marchandise fait l'objet d'un envoi sécurisé par transport ordinaire. Tout problème de casse devra être signalé dans les 24 heures après réception. Dans le cas où il ne vous serait pas possible de vérifier la marchandise au moment de la livraison réalisée par le transporteur, il vous faudra mentionner "Sous réserve de contrôle de l'état du contenu" sur le bordereau de réception. Passé le délai de 24 heures, le client devra contacter son représentant afin de résoudre l'incidence. Il est très important de vérifier la marchandise lors de sa réception.

ASSISTANCE TECHNIQUE ET SERVICE APRÈS-VENTE

Un réseau d'assistance technique distribué sur tout le territoire national et portugais vous proportionne la tranquillité d'avoir toujours près de vous un professionnel de Sanycces.

L'excellente qualité de nos produits est assurée par une gestion très stricte de notre service qualité. Cependant et en accord avec notre garantie, nous avons un service après-vente à votre disposition composé par une grande équipe de professionnels prêts à vous aider, à vous informer et à résoudre toute incidence.

La situation stratégique de nos centres d'assistance après-vente nous permet une réponse agile et rapide, coordonnée par nos bureaux centraux. Nous disposons des moyens nécessaires pour vous faire parvenir nos produits dans les meilleures conditions. Notre Service après-vente met à votre disposition une adresse email et un numéro de téléphone exclusif pour répondre à vos attentes:

postventa@sanycces.es

Int. (+34) 964 51 82 02

NOTICE: Sanycces, S.L., le fabricant, se réserve le droit, à tout moment, de modifier ou de supprimer tout produit, équipement ou composant présent dans ce catalogue et ce, sans préavis. Être en possession de notre Catalogue ou Tarif ne constitue en aucun cas un droit d'achat sur nos produits.

NOTICE: Le fabricant vous rappelle l'obligation de poser des panneaux ou des boîtiers pour faciliter l'accès aux dispositifs en cas d'intervention. Dans le matériel acrylique, les dimensions sont approximatives et peuvent varier. Tolérance ± 5 mm. Les dimensions pour la pose de la robinetterie sont orientatives.

NOTICE: Les couleurs des photographies ne sont pas contractuelles, pour une meilleure identification de la couleur, consultez la carte RAL ou NCS.

NORMES ET CERTIFICATIONS

- Lavabos:
UNE-EN 14688

Art direction and graphic design

Sanycces design team

Photography

Vicent Clausell (Clausell studio)

Print

Imedisa

Special thanks to:

Cerámica a mano alzada

Maora Cerámica

Orac Decor



Pol. Ind. Carabona
C/ Coure P-11 Apdo. 158
12530 Burriana (Castellón) SPAIN
Tel. +34 964 518 202
info@sanycces.es
www.sanycces.es

Sanycces se reserva el derecho a anular o modificar los productos o cualquiera de sus atributos que aparecen en este catálogo. La reproducción de los colores es aproximada.

Sanycces reserves the right to cancel or modify the products or any of their attributes appearing in this catalogue. Colour reproduction is approximate.

Sanycces se réserve le droit d'annuler ou de modifier les produits ou l'un de leurs attributs figurant dans ce catalogue. La reproduction des couleurs est approximative.