

GME
DIVISION BAÑOS



2022

**MAMPARAS Y
COMPLEMENTOS
DE BAÑO**

Servicio inmediato • 100% Stock

CERTIFICADOS DE CALIDAD



Preocupados por la calidad que ofrecemos a nuestros clientes, GME DIVISIÓN BAÑOS SL dispone de certificados que garantizan la calidad de todos sus productos, los cuales cumplen con todas las normativas europeas.

Al mismo tiempo, GME DIVISIÓN BAÑOS SL está asociado al instituto tecnológico AIDIMA, en el cual, se realizan inspecciones y ensayos de laboratorio para garantizar la calidad y buen funcionamiento de los productos que les ofrecemos.

BASIC 8-23



KENNA 24-31



TWENTY 32-37



CORREDERAS ALUMINIO

VITRO 38-49



PRESTIGE TITAN 50-61



AKTUAL 62-71



VETRUM 74-85



TEMPLE 86-93



ROTARY 94-101



CORREDERAS ACERO

FUTURA 102-111



CORREDERAS ACERO

MOVING 112-121



TRIO 124-125



TANDEM 126-127



OTRAS SOLUCIONES

PUERTAS DE PASO 128-129



GIRO 360° 130-133



BYPASS 134-135



AKORD 136-137



SCREEN 138-143



FIJOS

OPEN 148-181



ABATIBLES / PLEGABLES

GLASS 182-197



GLASS PLEGABLE 198-201



BASIC COLOR 204-215



COLOR

TWENTY BLACK 216-219



OPEN BLACK 220-241



BLACK CHESS 242-243



FIJOS CHESS / BLACK / WHITE

SCREEN BLACK 244



SCREEN WHITE 246



SCREEN BLACK BAÑERA 245



SCREEN WHITE BAÑERA 247



GLASS BAÑERA 250



SCREEN BAÑERA 251



OPEN BAÑERA 252



AKTUAL BAÑERA 254-257



LA MAYOR GAMA DE MAMPARAS
DEL MERCADO
CON ENTREGA INMEDIATA
PLAZO MEDIO DE ENTREGA 48H



BASIC pg.8



KENNA pg.24



TWENTY pg.32



COLOR pg.204

BLACK pg.216

VITRO pg.38



PRESTIGE TITAN pg.50



AKTUAL pg.62



**MAMPARAS
ALUMINIO
CORREDERAS**

basic

Amplitud de opciones y éxito en ventas

Mampara de aluminio con cristales de 6 mm.

Basic está disponible en todas las medidas en formatos; frontal, angular al vértice y angular con lateral fijo de 8 mm.

El modelo Basic se caracteriza por sus perfiles minimalistas de líneas rectas, ausencia de perfil inferior, así como su innovador pulsador liberador de hoja en el guiador para facilitar su limpieza.

Este modelo incluye tratamiento anticorrosión de serie.

NOVEDADES Y MEJORAS:

Guiador optimizado

Reducción de espacio entre cristales

Vierteaguas y gomas 100% silic. transparentes

Antivuelco

Formatos Spazio simétricos de 160 y 180

Lateral fijo de 75 cm

Opción altura 220 cm

Basic Color pag. 204





basic 1 fijo+1 corredera



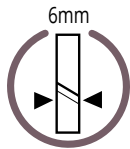
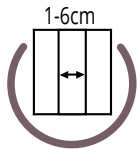
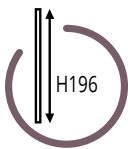

frontales BASIC 1fijo + 1corredera

Medida	Apertura	TRANSPARENTE	FROST PLUS
		Ref.	Ref.
95-100	36 - 41	5401	6401
100-105	36 - 41	5402	6402
105-110	41 - 46	5403	6403
110-115	41 - 46	5404	6404
115-120	46 - 51	5405	6405
120-125	46 - 51	5406	6406
125-130	51 - 56	5407	6407
130-135	51 - 56	5408	6408
135-140	56 - 61	5409	6409
140-145	56 - 61	5410	6410
145-150	61 - 66	5411	6411
150-155	61 - 66	5412	6412
155-160	61 - 66	5413	6413
160-165	61 - 66	5414	6414
165-170	66 - 71	5415	6415
170-175	61 - 66	5416	6416
175-180	66 - 71	5417	6417
180-190	67 - 76	*5455	*6455
190-200	72 - 81	*5456	*6456

*El cruce de las referencias 5455, 5456, 6455 y 6456 será 1-11 cm

Referencias	Descripción
5429	perfil de compensación +1,5 cm
0007	pletina embellecedora 195x3,8 cm



Nuevo guiador optimizado con pulsador liberador de hoja



Doble rodamiento regulable en nylon con antivuelco

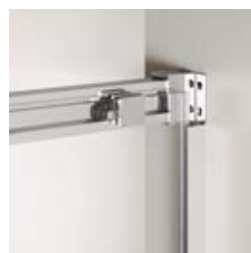

Perfectos acabados externos e internos



Mamparas a medida y cristales especiales	TRANSPARENTE	FROST PLUS / PARSOL CARGLASS / MATE
Altura hasta 195 cm	+45%	+55%
Altura de 195 hasta 220 cm	+75%	+85%



Opción tirador	Ref.
Extraplano 22x1,6x0,7 cm	1731
Largo 40x1,2x1,5 cm	1732

*Plazo de entrega 15 días (más información en pág. 258)

basic spazio 2fijos + 2correderas



frontales BASIC SPAZIO 2fijos + 2correderas

Referencias	Descripción	Apertura	Cruce	Rango
5029x2+5451	BASIC SPAZIO 140 (75+75)	46 - 56	1 - 6	132 - 142
5019x2+5451	BASIC SPAZIO 150 (80+80)	56 - 66	1 - 6	142 - 152
5030x2+5451	BASIC SPAZIO 160 (85+85)	64 - 74	1 - 6	152 - 162
5020x2+5451	BASIC SPAZIO 170 (90+90)	66 - 76	1 - 6	162 - 172
5031x2+5454	BASIC SPAZIO 180 (95+95)	72 - 82	1 - 6	172 - 182
5021x2+5454	BASIC SPAZIO 190 (100+100)	66 - 86	1 - 6	182 - 192
5001x2+5454	BASIC SPAZIO 200 (100+100)	76 - 86	1 - 6	190 - 200
5002x2+5454	BASIC SPAZIO 210 (105+105)	76 - 86	1 - 6	200 - 210

Se puede combinar con lateral fijo (ver pág. 18), usando ref. 0182 (indicar mano). El rango aumenta 1,2 cm en uno de los lados.

Referencias	Descripción
5429	perfil de compensación +1,5 cm
0182	opción perfil unión fijo-fijo (indicar mano), ver pág. 142

basic spazio frost plus 2fijos + 2correderas



frontales BASIC SPAZIO FROST PLUS 2fijos + 2correderas

Referencias	Descripción	Apertura	Cruce	Rango
6029x2+5451	BASIC SPAZIO FROST PLUS 140 (75+75)	46 - 56	1 - 6	132 - 142
6019x2+5451	BASIC SPAZIO FROST PLUS 150 (80+80)	56 - 66	1 - 6	142 - 152
6030x2+5451	BASIC SPAZIO FROST PLUS 160 (85+85)	64 - 74	1 - 6	152 - 162
6020x2+5451	BASIC SPAZIO FROST PLUS 170 (90+90)	66 - 76	1 - 6	162 - 172
6031x2+5454	BASIC SPAZIO FROST PLUS 180 (95+95)	72 - 82	1 - 6	172 - 182
6021x2+5454	BASIC SPAZIO FROST PLUS 190 (100+100)	66 - 86	1 - 6	182 - 192
6001x2+5454	BASIC SPAZIO FROST PLUS 200 (100+100)	76 - 86	1 - 6	190 - 200
6002x2+5454	BASIC SPAZIO FROST PLUS 210 (105+105)	76 - 86	1 - 6	200 - 210

Se puede combinar con lateral fijo (ver pág. 18), usando ref. 0182 (indicar mano). El rango aumenta 1,2 cm en uno de los lados.

Referencias	Descripción
5429	perfil de compensación +1,5 cm
0182	opción perfil unión fijo-fijo (indicar mano), ver pág. 142

basic fijo + puerta + fijo

NOVEDAD



Se puede combinar con el lateral fijo de la página 18, usando ref. 0182 (indicar mano). El rango aumenta 1,2 cm en uno de los lados.



Perfilería en aluminio pulido con stopper

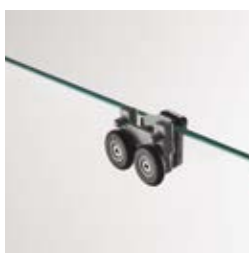

Doble rodamiento regulable en nylon con antivuelco

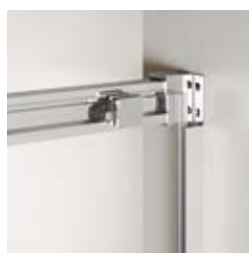

Embellecedores. Perfectos acabados externos e internos



Nuevo guiador optimizado con pulsador liberador de hoja

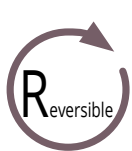
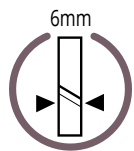
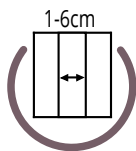
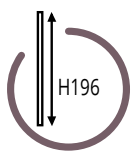

PASO 1: Seleccionar medida de la PERFILERÍA

PASO 2: Seleccionar medida/decorado FIJO EN LÍNEA

PASO 3: Seleccionar medida/decorado de los FRONTALES

Rango = (Rango Min/Max frontal + Medida fijo en línea)

PASO 1: PERFILERÍA

Descripción	Ref.
Accesorios frontal hasta 140 cm (2 rodamientos)	5434
Accesorios frontal hasta 180 cm (2 rodamientos)	5438
Accesorios frontal hasta 200 cm (3 rodamientos)	5446

PASO 2: FIJOS EN LÍNEA

Medida fijo	TRANSPARENTE		FROST PLUS	
	Ref.		Ref.	
Fijo de 30 cm + magnético unión	5018F+5467		6018F+5467	
Fijo de 35 cm + magnético unión	5019F+5467		6019F+5467	
Fijo de 40 cm + magnético unión	5020F+5467		6020F+5467	
Fijo de 45 cm + magnético unión	5021F+5467		6021F+5467	
Fijo de 52 cm + magnético unión	5002F+5467		6002F+5467	
Fijo de 55 cm + magnético unión	5022F+5467		6022F+5467	
Fijo de 57 cm + magnético unión	5004F+5467		6004F+5467	

PASO 3: FRONTALES

Descripción	Rangos (cm)	TRANSPARENTE		FROST PLUS	
		Ref.		Ref.	
Cristal fijo + puerta frontal de 100	95-100	5001		6001	
Cristal fijo + puerta frontal de 105	100-105	5002		6002	
Cristal fijo + puerta frontal de 110	105-110	5003		6003	
Cristal fijo + puerta frontal de 115	110-115	5004		6004	
Cristal fijo + puerta frontal de 120	115-120	5005		6005	
Cristal fijo + puerta frontal de 125	120-125	5006		6006	
Cristal fijo + puerta frontal de 130	125-130	5007		6007	
Cristal fijo + puerta frontal de 135	130-135	5008		6008	
Cristal fijo + puerta frontal de 140	135-140	5009		6009	
Cristal fijo + puerta frontal de 145	140-145	5010		6010	
Cristal fijo + puerta frontal de 150	145-150	5011		6011	
Cristal fijo + puerta frontal de 155	150-155	5012		6012	
Cristal fijo + puerta frontal de 160	155-160	5013		6013	
Cristal fijo + puerta frontal de 165	160-165	5014		6014	
Cristal fijo + puerta frontal de 170	165-170	5015		6015	
Cristal fijo + puerta frontal de 175	170-175	5016		6016	
Cristal fijo + puerta frontal de 180	175-180	5017		6017	
Cristal fijo + puerta frontal de 190	180-190	5023		6023	
Cristal fijo + puerta frontal de 200	190-200	5024		6024	



Fijos en línea a medida + magnético

Descripción
medida hasta 40 cm
medida de 40 hasta 80 cm

TRANSPARENTE	FROST PLUS	
	Ref.	
	1370	1372
	1371	1373

*Plazo de entrega 15 días

basic angular al vértice





combinaciones angular BASIC apertura al vértice

Medida	Rangos	Apertura	Referencias	Referencias
70x70	65-70/65-70	34 - 37	5018+5018+5423	6018+6018+5423
75x70	70-75/65-70	36 - 39	5029+5018+5423	6029+6018+5423
80x70	75-80/65-70	38 - 41	5019+5018+5423	6019+6018+5423
90x70	85-90/65-70	41 - 45	5020+5018+5423	6020+6018+5423
100x70	95-100/65-70	46 - 49	5021+5018+5423	6021+6018+5423
110x70	105-109/65-70	47 - 50	5002+5018+5423	6002+6018+5423
120x70	115-120/65-70	50 - 53	5022+5018+5423	6022+6018+5423
130x70	125-129/65-70	55 - 58	5006+5018+5424	6006+6018+5424
140x70	135-139/65-70	59 - 62	5008+5018+5424	6008+6018+5424
Medida	Rangos	Apertura	Referencias	Referencias
75x75	70-75/70-75	38 - 41	5029+5029+5423	6029+6029+5423
80x75	75-80/70-75	40 - 43	5019+5029+5423	6019+6029+5423
90x75	85-90/70-75	45 - 48	5020+5029+5423	6020+6029+5423
100x75	95-100/70-75	48 - 51	5021+5029+5423	6021+6029+5423
110x75	105-109/70-75	49 - 52	5002+5029+5423	6002+6029+5423
120x75	115-120/70-75	52 - 55	5022+5029+5423	6022+6029+5423
130x75	125-129/70-75	57 - 60	5006+5029+5424	6006+6029+5424
140x75	135-139/70-75	61 - 64	5008+5029+5424	6008+6029+5424
Medida	Rangos	Apertura	Referencias	Referencias
80x80	75-80/75-80	41 - 44	5019+5019+5423	6019+6019+5423
90x80	85-90/75-80	45 - 48	5020+5019+5423	6020+6019+5423
100x80	95-100/75-80	49 - 52	5021+5019+5423	6021+6019+5423
110x80	105-109/75-80	50 - 53	5002+5019+5423	6002+6019+5423
120x80	115-120/75-80	53 - 56	5022+5019+5423	6022+6019+5423
130x80	125-129/75-80	57 - 60	5006+5019+5424	6006+6019+5424
140x80	135-139/75-80	62 - 65	5008+5019+5424	6008+6019+5424
Medida	Rangos	Apertura	Referencias	Referencias
90x90	85-90/85-90	48 - 51	5020+5020+5423	6020+6020+5423
100x90	95-100/85-90	52 - 55	5021+5020+5423	6021+6020+5423
110x90	105-109/85-90	53 - 56	5002+5020+5423	6002+6020+5423
120x90	115-120/85-90	55 - 58	5022+5020+5423	6022+6020+5423
130x90	125-129/85-90	60 - 63	5006+5020+5424	6006+6020+5424
140x90	135-139/85-90	64 - 67	5008+5020+5424	6008+6020+5424

También disponible los nuevos lados de 85 y 95.

Referencias	Descripción
5429	perfil de compensación +1,5 cm



Mamparas a medida y cristales especiales	TRANSPARENTE	FROST PLUS / PARSOL CARGLASS / MATE
Altura hasta 195 cm	+45%	+55%
Altura de 195 hasta 220 cm	+75%	+85%

*Plazo de entrega 15 días (más información en pág. 258)

basic frontal + lateral fijo de 8 mm



Descripción	Rango	TRANSPARENTE	FROST PLUS
		Ref.	Ref.
lateral fijo BASIC 70	67 - 69	5425	6425
lateral fijo BASIC 75	72 - 74	5457	6457
lateral fijo BASIC 80	77 - 79	5426	6426
lateral fijo BASIC 90	87 - 89	5427	6427



Laterales fijos a medida

Descripción

medida hasta 40 cm
medida de 40 hasta 80 cm
medida de 80 hasta 120 cm

TRANSPARENTE

Ref.

1350

1334

1335

FROST PLUS

Ref.

1350+1312

1334+1313

1335+1315

*Plazo de entrega 15 días



combinaciones frontales **BASIC** + lateral fijo de 8 mm

Medida	Rangos	Apertura	TRANSPARENTE	FROST PLUS
100x70	95-100/67-69	38 - 43	Referencias 5401+5425	Referencias 6401+6425
110x70	105-110/67-69	43 - 48	5403+5425	6403+6425
120x70	115-120/67-69	48 - 53	5405+5425	6405+6425
130x70	125-130/67-69	53 - 58	5407+5425	6407+6425
140x70	135-140/67-69	58 - 63	5409+5425	6409+6425
150x70	145-150/67-69	63 - 68	5411+5425	6411+6425
160x70	155-160/67-69	63 - 68	5413+5425	6413+6425
170x70	165-170/67-69	68 - 73	5415+5425	6415+6425
180x70	175-180/67-69	68 - 73	5417+5425	6417+6425
100x75	95-100/72-74	38 - 43	Referencias 5401+5457	Referencias 6401+6457
110x75	105-110/72-74	43 - 48	5403+5457	6403+6457
120x75	115-120/72-74	48 - 53	5405+5457	6405+6457
130x75	125-130/72-74	53 - 58	5407+5457	6407+6457
140x75	135-140/72-74	58 - 63	5409+5457	6409+6457
150x75	145-150/72-74	63 - 68	5411+5457	6411+6457
160x75	155-160/72-74	63 - 68	5413+5457	6413+6457
170x75	165-170/72-74	68 - 73	5415+5457	6415+6457
180x75	175-180/72-74	68 - 73	5417+5457	6417+6457
100x80	95-100/77-79	38 - 43	Referencias 5401+5426	Referencias 6401+6426
110x80	105-110/77-79	43 - 48	5403+5426	6403+6426
120x80	115-120/77-79	48 - 53	5405+5426	6405+6426
130x80	125-130/77-79	53 - 58	5407+5426	6407+6426
140x80	135-140/77-79	58 - 63	5409+5426	6409+6426
150x80	145-150/77-79	63 - 68	5411+5426	6411+6426
160x80	155-160/77-79	63 - 68	5413+5426	6413+6426
170x80	165-170/77-79	68 - 73	5415+5426	6415+6426
180x80	175-180/77-79	68 - 73	5417+5426	6417+6426
100x90	95-100/87-89	38 - 43	Referencias 5401+5427	Referencias 6401+6427
110x90	105-110/87-89	43 - 48	5403+5427	6403+6427
120x90	115-120/87-89	48 - 53	5405+5427	6405+6427
130x90	125-130/87-89	53 - 58	5407+5427	6407+6427
140x90	135-140/87-89	58 - 63	5409+5427	6409+6427
150x90	145-150/87-89	63 - 68	5411+5427	6411+6427
160x90	155-160/87-89	63 - 68	5413+5427	6413+6427
170x90	165-170/87-89	68 - 73	5415+5427	6415+6427
180x90	175-180/87-89	68 - 73	5417+5427	6417+6427

Se pueden hacer combinaciones con medidas intermedias de frontales y hasta 2 metros.

Referencias	Descripción
5429	perfil de compensación +1,5 cm (sólo para los frontales)
0182	opción perfil unión fijo-fijo (indicar mano), ver pág. 142

basic free

Frontal Basic Free con perfil de 140 y fijo+corredera a 120, ref 5434+5447+5005



Perfilería en aluminio pulido con stopper

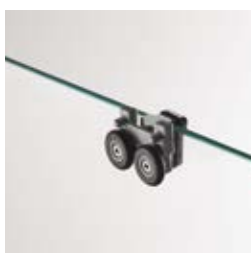

Doble rodamiento regulable en nylon con antivuelco

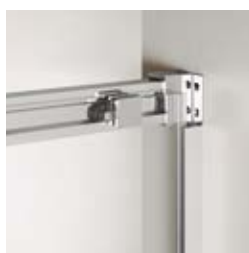

Embellecedores. Perfectos acabados externos e internos



Nuevo guiador optimizado con pulsador liberador de hoja

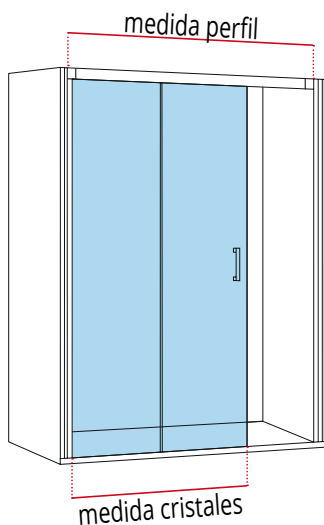

PASO 1: Seleccionar medida de la perfilería
PASO 2: Seleccionar medida de los cristales

PASO 1: PERFILERÍA

Descripción	Ref.
Perfilería y accesorios hasta 140 + KIT FREE	5434+5447
Perfilería y accesorios hasta 180 + KIT FREE	5438+5447
Perfilería y accesorios hasta 200 + KIT FREE	5446+5447

PASO 2: CRISTALES

Descripción	Rangos	TRANSPARENTE	FROST PLUS
		Ref.	Ref.
BASIC FREE 100	95-100	5001	6001
BASIC FREE 105	100-105	5002	6002
BASIC FREE 110	105-110	5003	6003
BASIC FREE 115	110-115	5004	6004
BASIC FREE 120	115-120	5005	6005
BASIC FREE 125	120-125	5006	6006
BASIC FREE 130	125-130	5007	6007
BASIC FREE 135	130-135	5008	6008
BASIC FREE 140	135-140	5009	6009
BASIC FREE 145	140-145	5010	6010
BASIC FREE 150	145-150	5011	6011
BASIC FREE 155	150-155	5012	6012
BASIC FREE 160	155-160	5013	6013
BASIC FREE 165	160-165	5014	6014
BASIC FREE 170	165-170	5015	6015
BASIC FREE 175	170-175	5016	6016
BASIC FREE 180	175-180	5017	6017
BASIC FREE 190	180-190	5023	6023
BASIC FREE 200	190-200	5024	6024

basic free angular



Mamparas a medida y cristales especiales	TRANSPARENTE	FROST PLUS / PARSOL CARGLASS / MATE
Altura hasta 195 cm	+45%	+55%
Altura de 195 hasta 220 cm	+75%	+85%

*Plazo de entrega 15 días (más información en pág. 258)

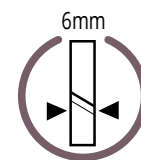
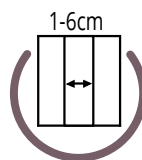
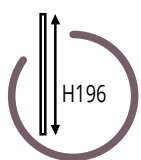

combinaciones angular BASIC FREE

		TRANSPARENTE	FROST PLUS
Medida	Rangos	Referencias	Referencias
70x70	65-70/65-70	5018+5423+5447	6018+5423+5447
75x70	70-75/65-70	5029+5423+5447	6029+5423+5447
80x70	75-80/65-70	5019+5423+5447	6019+5423+5447
90x70	85-90/65-70	5020+5423+5447	6020+5423+5447
100x70	95-100/65-70	5021+5423+5447	6021+5423+5447
110x70	105-109/65-70	5002+5423+5447	6002+5423+5447
120x70	115-120/65-70	5022+5423+5447	6022+5423+5447
130x70	125-129/65-70	5006+5424+5447	6006+5424+5447
140x70	135-139/65-70	5008+5424+5447	6008+5424+5447
Medida	Rangos	Referencias	Referencias
75x75	70-75/70-75	5029+5423+5447	6029+5423+5447
80x75	75-80/70-75	5019+5423+5447	6019+5423+5447
90x75	85-90/70-75	5020+5423+5447	6020+5423+5447
100x75	95-100/70-75	5021+5423+5447	6021+5423+5447
110x75	105-109/70-75	5002+5423+5447	6002+5423+5447
120x75	115-120/70-75	5022+5423+5447	6022+5423+5447
130x75	125-129/70-75	5006+5424+5447	6006+5424+5447
140x75	135-139/70-75	5008+5424+5447	6008+5424+5447
Medida	Rangos	Referencias	Referencias
80x80	75-80/75-80	5019+5423+5447	6019+5423+5447
90x80	85-90/75-80	5020+5423+5447	6020+5423+5447
100x80	95-100/75-80	5021+5423+5447	6021+5423+5447
110x80	105-109/75-80	5002+5423+5447	6002+5423+5447
120x80	115-120/75-80	5022+5423+5447	6022+5423+5447
130x80	125-129/75-80	5006+5424+5447	6006+5424+5447
140x80	135-139/75-80	5008+5424+5447	6008+5424+5447
Medida	Rangos	Referencias	Referencias
90x90	85-90/85-90	5020+5423+5447	6020+5423+5447
100x90	95-100/85-90	5021+5423+5447	6021+5423+5447
110x90	105-109/85-90	5002+5423+5447	6002+5423+5447
120x90	115-120/85-90	5022+5423+5447	6022+5423+5447
130x90	125-129/85-90	5006+5424+5447	6006+5424+5447
140x90	135-139/85-90	5008+5424+5447	6008+5424+5447

Referencias	Descripción
5429	perfil de compensación +1,5 cm

kenna

NOVEDAD

Evolución de la Tendencia

Su innovador sistema de rodamientos permite a este modelo el curso por el interior de su hoja, evitando así las pérdidas de espacio en la zona de ducha.

Kenna está fabricada con cristales de 8 mm y tratamiento antical. Su brazo estabilizador en acero inoxidable nos permite un funcionamiento perfecto en ausencia de perflería tanto superior como inferior dándole un total protagonismo al cristal y el motivo cerámico.

Este modelo está disponible en todas las medidas en formato frontal, free y angular con lateral fijo. Dispone de la opción de barra paralela.





kenna 1 fijo+1 corredera

NOVEDAD



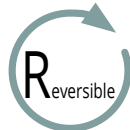
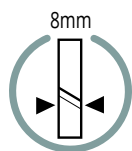
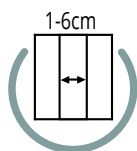

frontales Kenna 1fijo + 1corredera

Descripción	Rango	Apertura	Ref.
frontal ducha KENNA 100	95-100	34 - 39	6530
frontal ducha KENNA 105	100-105	37 - 42	6531
frontal ducha KENNA 110	105-110	39 - 44	6532
frontal ducha KENNA 115	110-115	42 - 47	6533
frontal ducha KENNA 120	115-120	44 - 49	6534
frontal ducha KENNA 125	120-125	47 - 52	6535
frontal ducha KENNA 130	125-130	49 - 54	6536
frontal ducha KENNA 135	130-135	52 - 57	6537
frontal ducha KENNA 140	135-140	52 - 57	6538
frontal ducha KENNA 145	140-145	57 - 62	6539
frontal ducha KENNA 150	145-150	57 - 62	6540
frontal ducha KENNA 155	150-155	62 - 67	6541
frontal ducha KENNA 160	155-160	64 - 69	6542
frontal ducha KENNA 165	160-165	64 - 69	6543
frontal ducha KENNA 170	165-170	64 - 69	6544
frontal ducha KENNA 175	170-175	64 - 69	6545
frontal ducha KENNA 180	175-180	64 - 69	6546



Opción barra paralela 200 - Ref. 6551



Barra guizador en acero



Opción barra paralela



Doble asa metálica



Rodamiento integrado en hoja

kenna free 1 fijo+1 corredera

NOVEDAD





frontales Kenna Free 1 fijo + 1 corredera

Descripción	Rango	Referencia
frontal ducha KENNA free 100	93-98	6530
frontal ducha KENNA free 105	98-103	6531
frontal ducha KENNA free 110	103-108	6532
frontal ducha KENNA free 115	108-113	6533
frontal ducha KENNA free 120	113-118	6534
frontal ducha KENNA free 125	118-123	6535
frontal ducha KENNA free 130	123-128	6536
frontal ducha KENNA free 135	128-133	6537
frontal ducha KENNA free 140	133-138	6538
frontal ducha KENNA free 145	138-143	6539
frontal ducha KENNA free 150	143-148	6540
frontal ducha KENNA free 155	148-153	6541
frontal ducha KENNA free 160	153-158	6542
frontal ducha KENNA free 165	158-163	6543
frontal ducha KENNA free 170	163-168	6544
frontal ducha KENNA free 175	168-173	6545
frontal ducha KENNA free 180	173-178	6546



Barra guiador en acero



Doble asa metálica



Rodamiento integrado en hoja



Descripción	Rango	Ref.
lateral fijo KENNA 70	67-69	6547
lateral fijo KENNA 75	72-74	6548
lateral fijo KENNA 80	77-79	6549
lateral fijo KENNA 90	87-89	6550



Laterales fijos a medida (más información en página 259)

Descripción	Ref.
medida hasta 40 cm	1365
medida de 40 hasta 80 cm	1366
medida de 80 hasta 120 cm	1367

*Plazo de entrega 15 días



combinaciones frontales KENNA + lateral fijo de 8 mm

Medida	Rangos	Referencias	Medida	Rangos	Referencias
100x70	95-100/67-69	6530+6547	100x75	95-100/72-74	6530+6548
110x70	105-110/67-69	6532+6547	110x75	105-110/72-74	6532+6548
120x70	115-120/67-69	6534+6547	120x75	115-120/72-74	6534+6548
130x70	125-130/67-69	6536+6547	130x75	125-130/72-74	6536+6548
140x70	135-140/67-69	6538+6547	140x75	135-140/72-74	6538+6548
150x70	145-150/67-69	6540+6547	150x75	145-150/72-74	6540+6548
160x70	155-160/67-69	6542+6547	160x75	155-160/72-74	6542+6548
170x70	165-170/67-69	6544+6547	170x75	165-170/72-74	6544+6548
180x70	175-180/67-69	6546+6547	180x75	175-180/72-74	6546+6548
Medida	Rangos	Referencias	Medida	Rangos	Referencias
100x80	95-100/77-79	6530+6549	100x90	95-100/87-89	6530+6550
110x80	105-110/77-79	6532+6549	110x90	105-110/87-89	6532+6550
120x80	115-120/77-79	6534+6549	120x90	115-120/87-89	6534+6550
130x80	125-130/77-79	6536+6549	130x90	125-130/87-89	6536+6550
140x80	135-140/77-79	6538+6549	140x90	135-140/87-89	6538+6550
150x80	145-150/77-79	6540+6549	150x90	145-150/87-89	6540+6550
160x80	155-160/77-79	6542+6549	160x90	155-160/87-89	6542+6550
170x80	165-170/77-79	6544+6549	170x90	165-170/87-89	6544+6550
180x80	175-180/77-79	6546+6549	180x90	175-180/87-89	6546+6550

Se pueden hacer combinaciones con medidas intermedias de frontales y hasta 175 cm. La apertura es +2 cm que en el frontal.



Opción barra Inox 200 - Ref. 6551



Barra guiador en acero



Opción barra paralela



Doble asa metálica



Rodamiento integrado en hoja

twenty

NOVEDAD

Minimalismo en esencia

Twenty está fabricada con una perflería en aluminio de tan solo 20 mm y ausencia de perflería inferior, lo cual, le otorga una gran belleza minimalista a su diseño.

En esta serie incorporamos un novedoso sistema de cierre automático SOFT CLOSE de fácil acceso.

Este modelo está disponible en formato frontal y angular con lateral fijo, se puede escoger entre perflería cromo brillo o negro mate. Sus cristales de 6 mm llevan tratamiento antical para facilitar su limpieza y mantenimiento.

NOVEDAD

TWENTY BLACK en página 216

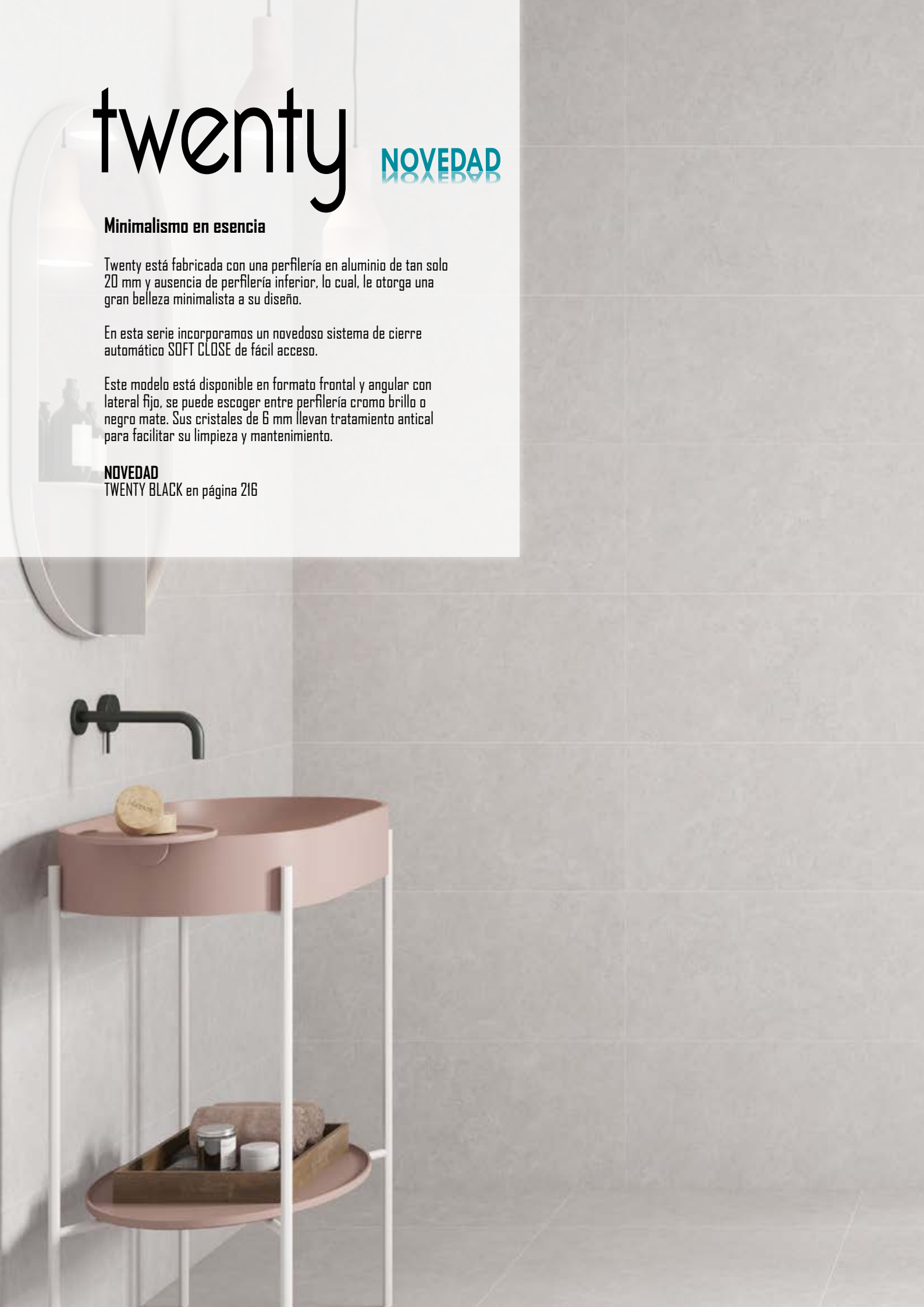



twenty 1 fijo+1 corredera

NOVEDAD





frontales **TWENTY** 1 fijo + 1 corredera

Descripción	Rango	Apertura	Ref.
frontal ducha TWENTY 120	115-120	46 - 51	2000+2021
frontal ducha TWENTY 125	120-125	49 - 54	2001+2021
frontal ducha TWENTY 130	125-130	51 - 56	2002+2021
frontal ducha TWENTY 135	130-135	54 - 59	2003+2021
frontal ducha TWENTY 140	135-140	56 - 61	2004+2021
frontal ducha TWENTY 145	140-145	59 - 64	2005+2021
frontal ducha TWENTY 150	145-150	61 - 66	2006+2021
frontal ducha TWENTY 155	150-155	64 - 69	2007+2022
frontal ducha TWENTY 160	155-160	66 - 71	2008+2022
frontal ducha TWENTY 165	160-165	69 - 74	2009+2022
frontal ducha TWENTY 170	165-170	71 - 76	2010+2022
frontal ducha TWENTY 175	170-175	74 - 79	2011+2022
frontal ducha TWENTY 180	175-180	76 - 81	2012+2022



Guiador desmontable



Doble asa metálica



Rodamiento oculto



Cierre soft close



Mamparas a medida y cristales especiales

TRANSPARENTE

+45%

FROST PLUS / PARSOL
CARGLASS / MATE

+55%

*Plazo de entrega 15 días (más información en pág. 258)



Descripción	Rango	Ref.
lateral fijo TWENTY 70	66,5-69,5	2013
lateral fijo TWENTY 75	71,5-74,5	2014
lateral fijo TWENTY 80	76,5-79,5	2015
lateral fijo TWENTY 90	86,5-89,5	2016



Laterales fijos a medida (más información en página 259)

Referencias	Descripción
1375	lateral fijo a medida TWENTY hasta 40 cm
1376	lateral fijo a medida TWENTY de 40 hasta 80 cm
1377	lateral fijo a medida TWENTY de 80 hasta 120 cm

*Plazo de entrega 15 días

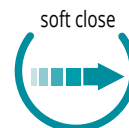
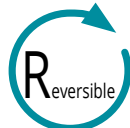
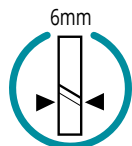
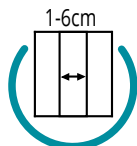
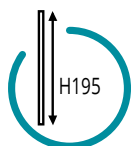

combinaciones frontales **TWENTY** + lateral fijo de 6 mm

Medida	Rangos	Referencias	Medida	Rangos	Referencias
120X70	115-120/66,5-69,5	2000+2021+2013	120X75	115-120/71,5-74,5	2000+2021+2014
125X70	120-125/66,5-69,5	2001+2021+2013	125X75	120-125/71,5-74,5	2001+2021+2014
130X70	125-130/66,5-69,5	2002+2021+2013	130X75	125-130/71,5-74,5	2002+2021+2014
135X70	130-135/66,5-69,5	2003+2021+2013	135X75	130-135/71,5-74,5	2003+2021+2014
140X70	135-140/66,5-69,5	2004+2021+2013	140X75	135-140/71,5-74,5	2004+2021+2014
145X70	140-145/66,5-69,5	2005+2021+2013	145X75	140-145/71,5-74,5	2005+2021+2014
150X70	145-150/66,5-69,5	2006+2021+2013	150X75	145-150/71,5-74,5	2006+2021+2014
155X70	150-155/66,5-69,5	2007+2022+2013	155X75	150-155/71,5-74,5	2007+2022+2014
160X70	155-160/66,5-69,5	2008+2022+2013	160X75	155-160/71,5-74,5	2008+2022+2014
165X70	160-165/66,5-69,5	2009+2022+2013	165X75	160-165/71,5-74,5	2009+2022+2014
170X70	165-170/66,5-69,5	2010+2022+2013	170X75	165-170/71,5-74,5	2010+2022+2014
175X70	170-175/66,5-69,5	2011+2022+2013	175X75	170-175/71,5-74,5	2011+2022+2014
180X70	175-180/66,5-69,5	2012+2022+2013	180X75	175-180/71,5-74,5	2012+2022+2014
Medida	Rangos	Referencias	Medida	Rangos	Referencias
120X80	115-120/76,5-79,5	2000+2021+2015	120X90	115-120/86,5-89,5	2000+2021+2016
125X80	120-125/76,5-79,5	2001+2021+2015	125X90	120-125/86,5-89,5	2001+2021+2016
130X80	125-130/76,5-79,5	2002+2021+2015	130X90	125-130/86,5-89,5	2002+2021+2016
135X80	130-135/76,5-79,5	2003+2021+2015	135X90	130-135/86,5-89,5	2003+2021+2016
140X80	135-140/76,5-79,5	2004+2021+2015	140X90	135-140/86,5-89,5	2004+2021+2016
145X80	140-145/76,5-79,5	2005+2021+2015	145X90	140-145/86,5-89,5	2005+2021+2016
150X80	145-150/76,5-79,5	2006+2021+2015	150X90	145-150/86,5-89,5	2006+2021+2016
155X80	150-155/76,5-79,5	2007+2022+2015	155X90	150-155/86,5-89,5	2007+2022+2016
160X80	155-160/76,5-79,5	2008+2022+2015	160X90	155-160/86,5-89,5	2008+2022+2016
165X80	160-165/76,5-79,5	2009+2022+2015	165X90	160-165/86,5-89,5	2009+2022+2016
170X80	165-170/76,5-79,5	2010+2022+2015	170X90	165-170/86,5-89,5	2010+2022+2016
175X80	170-175/76,5-79,5	2011+2022+2015	175X90	170-175/86,5-89,5	2011+2022+2016
180X80	175-180/76,5-79,5	2012+2022+2015	180X90	175-180/86,5-89,5	2012+2022+2016

Las aperturas son las mismas que en los frontales



Guiador desmontable



Doble asa metálica



Rodamiento oculto



Cierre soft close

vitro

Vanguardia y protagonismo del cristal

Fabricada con cristales de 6 mm con tratamiento antical. Vitro está disponible en todas las medidas, en formatos frontal, free, angular al vértice, angular con lateral fijo de 8 mm y frontal con fijo en línea.

Vitro se caracteriza por la ausencia de perfilera superior e inferior y su innovador sistema de apertura mediante un brazo en acero inoxidable que actúa de guiador y soporte del fijo. Al mismo tiempo que el vierteaguas metálico guía los rodamientos ocultos de la mampara dándole un mayor protagonismo al cristal y la sensación de amplitud.

NOVEDADES Y MEJORAS:

Guiador optimizado

Reducción de espacio entre cristales

Vierteaguas y gomas 100% silic. transparentes

Rodamientos minimalistas

Formatos Spazio simétricos de 160 y 180

Lateral fijo de 75 cm





vitro 1 fijo + 1 corredera



Mamparas a medida y cristales especiales

TRANSPARENTE

+45%

FROST PLUS / PARSOL
CARGLASS / MATE

+55%

*Plazo de entrega 15 días (más información en pág. 258)



frontales VITRO

Referencias	Descripción	Apertura	Rango
5501	frontal ducha VITRO 100	36 - 41	95-100
5502	frontal ducha VITRO 105	36 - 41	100-105
5503	frontal ducha VITRO 110	41 - 46	105-110
5504	frontal ducha VITRO 115	41 - 46	110-115
5505	frontal ducha VITRO 120	46 - 51	115-120
5506	frontal ducha VITRO 125	46 - 51	120-125
5507	frontal ducha VITRO 130	51 - 56	125-130
5508	frontal ducha VITRO 135	51 - 56	130-135
5509	frontal ducha VITRO 140	56 - 61	135-140
5510	frontal ducha VITRO 145	56 - 61	140-145
5511	frontal ducha VITRO 150	61 - 66	145-150
5512	frontal ducha VITRO 155	61 - 66	150-155
5513	frontal ducha VITRO 160	61 - 66	155-160
5514	frontal ducha VITRO 165	61 - 66	160-165
5515	frontal ducha VITRO 170	66 - 71	165-170
5516	frontal ducha VITRO 175	61 - 66	170-175
5517	frontal ducha VITRO 180	66 - 71	175-180
5429	perfil de compensación +1,5 cm		
5546	opción barra inox paralela hasta 2 m		
0007	pletina embellecedora 195x3,8 cm		

OPCIÓN VITRO FREE



El rango pierde 2 cm

OPCIÓN BARRA PARALELA ref 5546



vitro spazio 2fijos + 2correderas





frontales **VITRO SPAZIO** 2fijos+2correderas

Referencias	Descripción	Apertura	Rango
5029x2+5552	VITRO SPAZIO 140 (75+75)	46 - 56	132 - 142
5019x2+5552	VITRO SPAZIO 150 (80+80)	56 - 66	142 - 152
5030x2+5552	VITRO SPAZIO 160 (85+85)	64 - 74	152 - 162
5020x2+5552	VITRO SPAZIO 170 (90+90)	66 - 76	162 - 172
5031x2+5554	VITRO SPAZIO 180 (95+95)	72 - 82	172 - 182
5021x2+5554	VITRO SPAZIO 190 (100+100)	66 - 86	182 - 192
5001x2+5554	VITRO SPAZIO 200 (100+100)	76 - 86	190 - 200
5002x2+5554	VITRO SPAZIO 210 (105+105)	76 - 86	200 - 210
0007	pletina embellecedora 195x3,8 cm		

Se puede combinar con el lateral fijo de la página 46 usando ref. 0182. El rango aumenta 1,2 cm en uno de los lados.



Rodamiento oculto sobre guía



Reducción dist. entre cristales



Brazo orientable



Mamparas a medida y cristales especiales

TRANSPARENTE

+45%

FROST PLUS / PARSOL
CARGLASS / MATE

+55%

CAJONADO

+21

*Plazo de entrega 15 días (más información en pág. 258)

vitro angular al vértice





combinaciones VITRO apertura al vértice

Medidas	Referencias	Rangos	Apertura
70x70	5018+5018+5523	64-69/64-69	34 - 37
75x70	5029+5018+5523	69-74/64-69	36 - 39
80x70	5019+5018+5523	74-79/64-69	38 - 41
90x70	5020+5018+5523	84-89/64-69	41 - 45
100x70	5021+5018+5523	94-99/64-69	46 - 49
110x70	5003+5018+5523	107-112/64-69	47 - 50
120x70	5022+5018+5523	114-119/64-69	50 - 53
130x70	5007+5018+5524	127-132/64-69	55 - 58
140x70	5009+5018+5524	137-142/64-69	59 - 62
Medidas	Referencias	Rangos	Apertura
75x75	5029+5029+5523	69-74/69-74	38 - 41
80x75	5019+5029+5523	74-79/69-74	40 - 43
90x75	5020+5029+5523	84-89/69-74	45 - 48
100x75	5021+5029+5523	94-99/69-74	48 - 51
110x75	5003+5029+5523	107-112/69-74	49 - 52
120x75	5022+5029+5523	114-119/69-74	52 - 55
130x75	5007+5029+5524	127-132/69-74	57 - 60
140x75	5009+5029+5524	137-142/69-74	61 - 64
Medidas	Referencias	Rangos	Apertura
80x80	5019+5019+5523	74-79/74-79	41 - 44
90x80	5020+5019+5523	84-89/74-79	45 - 48
100x80	5021+5019+5523	94-99/74-79	49 - 52
110x80	5003+5019+5523	107-112/74-79	50 - 53
120x80	5022+5019+5523	114-119/74-79	53 - 56
130x80	5007+5019+5524	127-132/74-79	57 - 60
140x80	5009+5019+5524	137-142/74-79	62 - 65
Medidas	Referencias	Rangos	Apertura
90x90	5020+5020+5523	84-89/84-89	48 - 51
100x90	5021+5020+5523	94-99/84-89	52 - 55
110x90	5003+5020+5523	107-112/84-89	53 - 56
120x90	5022+5020+5523	114-119/84-89	55 - 58
130x90	5007+5020+5524	127-132/84-89	60 - 63
140x90	5009+5020+5524	137-142/84-89	64 - 67
0007	pletina embellecedora 195x3,8 cm		

Se pueden combinar frontales de medidas intermedias, rango +2 cm.



Guiador y soporte fijo en acero



Nuevo rod. minimal blindado



Reducción dist. entre cristales

vitro frontal + lateral fijo de 8 mm



Referencias	Descripción	Rango
5525	lateral fijo VITRO 70	67 - 69
5557	lateral fijo VITRO 75	72 - 74
5526	lateral fijo VITRO 80	77 - 79
5527	lateral fijo VITRO 90	87 - 89



combinaciones frontales VITRO + lateral fijo de 8 mm

Medidas	Referencias	Rangos	Medidas	Referencias	Rangos
100x70	5501+5525	95-100/67-69	100x75	5501+5557	95-100/72-74
110x70	5503+5525	105-110/67-69	110x75	5503+5557	105-110/72-74
120x70	5505+5525	115-120/67-69	120x75	5505+5557	115-120/72-74
130x70	5507+5525	125-130/67-69	130x75	5507+5557	125-130/72-74
140x70	5509+5525	135-140/67-69	140x75	5509+5557	135-140/72-74
150x70	5511+5525	145-150/67-69	150x75	5511+5557	145-150/72-74
160x70	5513+5525	155-160/67-69	160x75	5513+5557	155-160/72-74
170x70	5515+5525	165-170/67-69	170x75	5515+5557	165-170/72-74
180x70	5517+5525	175-180/67-69	180x75	5517+5557	175-180/72-74
Medidas	Referencias	Rangos	Medidas	Referencias	Rangos
100x80	5501+5526	95-100/77-79	100x90	5501+5527	95-100/87-89
110x80	5503+5526	105-110/77-79	110x90	5503+5527	105-110/87-89
120x80	5505+5526	115-120/77-79	120x90	5505+5527	115-120/87-89
130x80	5507+5526	125-130/77-79	130x90	5507+5527	125-130/87-89
140x80	5509+5526	135-140/77-79	140x90	5509+5527	135-140/87-89
150x80	5511+5526	145-150/77-79	150x90	5511+5527	145-150/87-89
160x80	5513+5526	155-160/77-79	160x90	5513+5527	155-160/87-89
170x80	5515+5526	165-170/77-79	170x90	5515+5527	165-170/87-89
180x80	5517+5526	175-180/77-79	180x90	5517+5527	175-180/87-89

0007 pletina embellecedora

Opción perfil unión fijo + fijo usando ref. 0182, aumenta rango 1,2 cm en uno de los lados. El lateral fijo debe ser a medida. Se pueden combinar frontales de medidas intermedias, el rango no varía. Las aperturas son las mismas que en los frontales.



Guiador y soporte fijo en acero



Nuevo rod. minimal blindado



Detalle unión con lat. fijo



Laterales fijos a medida (más información en página 259)

Referencias	Descripción
1351	lateral fijo a medida VITRO hasta 40 cm
1352	lateral fijo a medida VITRO de 40 hasta 80 cm
1353	lateral fijo a medida VITRO de 80 hasta 120 cm

*Plazo de entrega 15 días

vitro frontal + fijo en línea



Medidas	Referencias	Descripción	Rango
120	5001+5534+1200+1213	VITRO 100+ FIJO 20	113-120
125	5002+5534+1200+1213	VITRO 105+ FIJO 20	117-125
130	5003+5534+1200+1213	VITRO 110+ FIJO 20	123-130
135	5004+5534+1200+1213	VITRO 115+ FIJO 20	128-135
140	5005+5534+1200+1213	VITRO 120+ FIJO 20	133-140
145	5006+5538+1200+1213	VITRO 125+ FIJO 20	138-145
150	5007+5538+1200+1213	VITRO 130+ FIJO 20	143-150
155	5008+5538+1200+1213	VITRO 135+ FIJO 20	147-155
160	5009+5538+1200+1213	VITRO 140+ FIJO 20	152-160
165	5010+5538+1200+1213	VITRO 145+ FIJO 20	157-165
170	5011+5538+1200+1213	VITRO 150+ FIJO 20	162-170
175	5012+5538+1200+1213	VITRO 155+ FIJO 20	167-175
180	5013+5538+1200+1213	VITRO 160+ FIJO 20	172-180



Medidas	Referencias	Descripción	Rango
125	5001+5534+1201+1213	VITRO 100+ FIJO 25	117-125
130	5002+5534+1201+1213	VITRO 105+ FIJO 25	123-130
135	5003+5534+1201+1213	VITRO 110+ FIJO 25	128-135
140	5004+5534+1201+1213	VITRO 115+ FIJO 25	133-140
145	5005+5538+1201+1213	VITRO 120+ FIJO 25	138-145
150	5006+5538+1201+1213	VITRO 125+ FIJO 25	143-150
155	5007+5538+1201+1213	VITRO 130+ FIJO 25	147-155
160	5008+5538+1201+1213	VITRO 135+ FIJO 25	152-160
165	5009+5538+1201+1213	VITRO 140+ FIJO 25	157-165
170	5010+5538+1201+1213	VITRO 145+ FIJO 25	162-170
175	5011+5538+1201+1213	VITRO 150+ FIJO 25	167-175
180	5012+5538+1201+1213	VITRO 155+ FIJO 25	172-180
130	5001+5534+1202+1213	VITRO 100+ FIJO 30	123-130
135	5002+5534+1202+1213	VITRO 105+ FIJO 30	128-135
140	5003+5534+1202+1213	VITRO 110+ FIJO 30	133-140
145	5004+5538+1202+1213	VITRO 115+ FIJO 30	138-145
150	5005+5538+1202+1213	VITRO 120+ FIJO 30	143-150
155	5006+5538+1202+1213	VITRO 125+ FIJO 30	147-155
160	5007+5538+1202+1213	VITRO 130+ FIJO 30	152-160
165	5008+5538+1202+1213	VITRO 135+ FIJO 30	157-165
170	5009+5538+1202+1213	VITRO 140+ FIJO 30	162-170
175	5010+5538+1202+1213	VITRO 145+ FIJO 30	167-175
180	5011+5538+1202+1213	VITRO 150+ FIJO 30	172-180
140	5001+5534+1203+1213	VITRO 100+ FIJO 40	133-140
145	5002+5538+1203+1213	VITRO 105+ FIJO 40	138-145
150	5003+5538+1203+1213	VITRO 110+ FIJO 40	143-150
155	5004+5538+1203+1213	VITRO 115+ FIJO 40	147-155
160	5005+5538+1203+1213	VITRO 120+ FIJO 40	152-160
165	5006+5538+1203+1213	VITRO 125+ FIJO 40	157-165
170	5007+5538+1203+1213	VITRO 130+ FIJO 40	162-170
175	5008+5538+1203+1213	VITRO 135+ FIJO 40	167-175
180	5009+5538+1203+1213	VITRO 140+ FIJO 40	172-180
150	5001+5538+1204+1213	VITRO 100+ FIJO 50	143-150
155	5002+5538+1204+1213	VITRO 105+ FIJO 50	147-155
160	5003+5538+1204+1213	VITRO 110+ FIJO 50	152-160
165	5004+5538+1204+1213	VITRO 115+ FIJO 50	157-165
170	5005+5538+1204+1213	VITRO 120+ FIJO 50	162-170
175	5006+5538+1204+1213	VITRO 125+ FIJO 50	167-175
180	5007+5538+1204+1213	VITRO 130+ FIJO 50	172-180
160	5001+5538+1205+1213	VITRO 100+ FIJO 60	152-160
165	5002+5538+1205+1213	VITRO 105+ FIJO 60	157-165
170	5003+5538+1205+1213	VITRO 110+ FIJO 60	162-170
175	5004+5538+1205+1213	VITRO 115+ FIJO 60	167-175
180	5005+5538+1205+1213	VITRO 120+ FIJO 60	172-180

Opción perfil unión fijo + fijo usando ref. 0182, aumenta rango 1,2 cm en uno de los lados. El lateral fijo debe ser a medida.

Prestige Titan

Calidades Prestige a precio Titan

Mampara de aluminio con cristales fijos de 8 mm y correderas de 6 mm. El modelo Prestige Titan está disponible en todas las medidas y formatos en cristal transparente y frost plus.

El modelo Prestige Titan se caracteriza por su perfilesa minimalista recta y por ser la única mampara enmarcada en aluminio, así como por su innovador sistema de cierre con magnético oculto. Al mismo tiempo incorpora rodamientos inferiores con pulsador que nos permiten liberar la hoja para facilitar la limpieza de su perfil inferior.

Esta serie incluye tratamiento anticad de serie.

NOVEDADES Y MEJORAS:

Vierteaguas y gomas 100% silic. transparentes
Lado de 75 cm





Prestige Titan Semicircular



tirador metálico



rodamiento rfzdo. doble



pulsador liberador



Ref.	Descripción	Apertura	Rango
0011	SEMICIRCULAR 80x80 RADIO ITALIANO	46	76,5 - 79,5
0013	SEMICIRCULAR 90x90 RADIO ITALIANO	52	86,5 - 89,5
0046	SEMICIRCULAR 80x80 RADIO ROCA	46	76,5 - 79,5
0047	SEMICIRCULAR 90x90 RADIO ROCA	52	86,5 - 89,5
0218	perfil de compensación +2 cm		
0029	perfil de compensación +4 cm		

Prestige Titan frost plus Semicircular

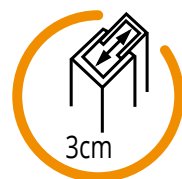
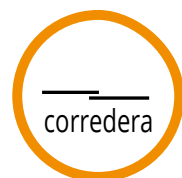
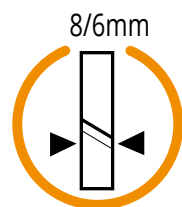
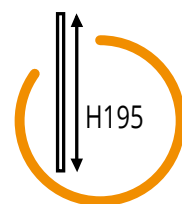

Ref.	Descripción	Apertura	Rango
0052	SEMICIRCULAR 80x80 RADIO ITALIANO	46	76,5 - 79,5
0053	SEMICIRCULAR 90x90 RADIO ITALIANO	52	86,5 - 89,5
0048	SEMICIRCULAR 80x80 RADIO ROCA	46	76,5 - 79,5
0049	SEMICIRCULAR 90x90 RADIO ROCA	52	86,5 - 89,5
0218	perfil de compensación +2 cm		
0029	perfil de compensación +4 cm		

Prestige Titan 1 fijo+1 corredera



cierre imán oculto



rodamiento rfzdo. doble



pulsador liberador

PRESTIGE TITAN 1 fijo +1 corredera

Referencias	Descripción	Apertura	Rangos
0200	PRESTIGE TITAN 100X195	38	97 - 103
0201	PRESTIGE TITAN 110X195	43	107 - 113
0202	PRESTIGE TITAN 120X195	48	117 - 123
0203	PRESTIGE TITAN 130X195	53	127 - 133
0204	PRESTIGE TITAN 140X195	58	137 - 143
0205	PRESTIGE TITAN 150X195	63	147 - 153
0206	PRESTIGE TITAN 160X195	58	157 - 163
0207	PRESTIGE TITAN 170X195	63	167 - 173
0218	perfil compensación +2 cm		
0029	perfil compensación +4 cm		



Prestige Titan frost plus 1 fijo+1 corredera

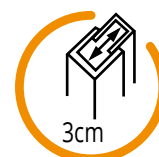
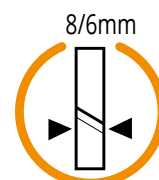
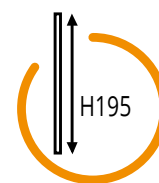

PRESTIGE TITAN FROST PLUS 1 fijo +1 corredera

Referencias	Descripción	Apertura	Rangos
0272	PRESTIGE TITAN FROST PLUS 100X195	38	97 - 103
0273	PRESTIGE TITAN FROST PLUS 110X195	43	107 - 113
0274	PRESTIGE TITAN FROST PLUS 120X195	48	117 - 123
0275	PRESTIGE TITAN FROST PLUS 130X195	53	127 - 133
0276	PRESTIGE TITAN FROST PLUS 140X195	58	137 - 143
0277	PRESTIGE TITAN FROST PLUS 150X195	63	147 - 153
0278	PRESTIGE TITAN FROST PLUS 160X195	58	157 - 163
0279	PRESTIGE TITAN FROST PLUS 170X195	63	167 - 173
0218	perfil compensación +2 cm		
0029	perfil compensación +4 cm		



Prestige Titan spazio 2f+2c



tirador metálico



rodamiento rfzdo. doble



pulsador liberador

PRESTIGE TITAN SPAZIO 2fijos +2correderas

Ref.	Descripción	Apertura	Rangos
0610	PRESTIGE TITAN SPAZIO 140X195	53	136 - 142
0611	PRESTIGE TITAN SPAZIO 150X195	58	146 - 152
0612	PRESTIGE TITAN SPAZIO 160X195	63	156 - 162
0613	PRESTIGE TITAN SPAZIO 170X195	68	166 - 172
0614	PRESTIGE TITAN SPAZIO 180X195	73	176 - 182
0615	PRESTIGE TITAN SPAZIO 190X195	78	186 - 192
0218	perfil compensación +2 cm		
0029	perfil compensación +4 cm		



*Se puede combinar con el lateral fijo STD (ver pág. 60), el rango aumenta en 0,7 y se pierde la expansión en el lado dónde se instala el fijo.

Prestige Titan spazio frost plus 2f+2c

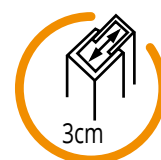
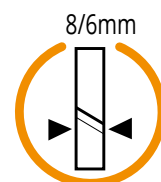
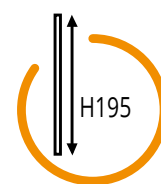

PRESTIGE TITAN SPAZIO FROST PLUS 2fijos +2correderas

Ref.	Descripción	Apertura	Rangos
0616	PRESTIGE TITAN SPAZIO FROST PLUS 140X195	53	136 - 142
0617	PRESTIGE TITAN SPAZIO FROST PLUS 150X195	58	146 - 152
0618	PRESTIGE TITAN SPAZIO FROST PLUS 160X195	63	156 - 162
0619	PRESTIGE TITAN SPAZIO FROST PLUS 170X195	68	166 - 172
0620	PRESTIGE TITAN SPAZIO FROST PLUS 180X195	73	176 - 182
0621	PRESTIGE TITAN SPAZIO FROST PLUS 190X195	78	186 - 192
0218	perfil compensación +2 cm		
0029	perfil compensación +4 cm		



*Se puede combinar con el lateral fijo STD Frost Plus (ver pág. 60), el rango aumenta en 0,7 y se pierde la expansión en el lado dónde se instala el fijo.

Prestige Titan angular al vértice



Descripción	TRANSPARENTE	FROST PLUS
	Ref.	Ref.
lado 70x195 PRESTIGE TITAN	0313	0295
lado 75x195 PRESTIGE TITAN	0375	0294
lado 80x195 PRESTIGE TITAN	0314	0296
lado 90x195 PRESTIGE TITAN	0315	0297
lado 100x195 PRESTIGE TITAN	0316	0298
lado 120x195 PRESTIGE TITAN	0317	0299



tirador metálico



rodamiento rfzdo. doble



pulsador liberador

Medida	Rangos	Apert.
70x70	67-70 / 67-70	33
80x70	77-80 / 67-70	37
90x70	87-90 / 67-70	41
100x70	97-100 / 67-70	45
110x70	104-107 / 67-70	47
120x70	117-120 / 67-70	50
130x70	124-127 / 67-70	56
140x70	134-137 / 67-70	60
150x70	144-147 / 67-70	64
160x70	154-157 / 67-70	60
170x70	164-167 / 67-70	64

Medida	Rangos	Apert.
70x75	67-70 / 72-75	35
75x75	72-75 / 72-75	37
80x75	77-80 / 72-75	39
90x75	87-90 / 72-75	42
100x75	97-100 / 72-75	47
110x75	104-107 / 72-75	49
120x75	117-120 / 72-75	52
130x75	124-127 / 72-75	58
140x75	134-137 / 72-75	62
150x75	144-147 / 72-75	66
160x75	154-157 / 72-75	62
170x75	164-167 / 72-75	66

Medida	Rangos	Apert.
80x80	77-80 / 77-80	40
90x80	87-90 / 77-80	44
100x80	97-100 / 77-80	48
110x80	104-107 / 77-80	50
120x80	117-120 / 77-80	52
130x80	124-127 / 77-80	58
140x80	134-137 / 77-80	62
150x80	144-147 / 77-80	66
160x80	154-157 / 77-80	62
170x80	164-167 / 77-80	66

Medida	Rangos	Apert.
90x90	87-90 / 87-90	47
100x90	97-100 / 87-90	51
110x90	104-107 / 87-90	53
120x90	117-120 / 87-90	55
130x90	124-127 / 87-90	60
140x90	134-137 / 87-90	64
150x90	144-147 / 87-90	68
160x90	154-157 / 87-90	64
170x90	164-167 / 87-90	68

TRANSPARENTE	FROST PLUS
Referencias	Referencias
0313 + 0313	0295 + 0295
0314 + 0313	0296 + 0295
0315 + 0313	0297 + 0295
0316 + 0313	0298 + 0295
0201 + 0313	0273 + 0295
0317 + 0313	0299 + 0295
0203 + 0313	0275 + 0295
0204 + 0313	0276 + 0295
0205 + 0313	0277 + 0295
0206 + 0313	0278 + 0295
0207 + 0313	0279 + 0295
Referencias	Referencias
0313 + 0375	0295 + 0294
0375 + 0375	0294 + 0294
0314 + 0375	0296 + 0294
0315 + 0375	0297 + 0294
0316 + 0375	0298 + 0294
0201 + 0375	0273 + 0294
0317 + 0375	0299 + 0294
0203 + 0375	0275 + 0294
0204 + 0375	0276 + 0294
0205 + 0375	0277 + 0294
0206 + 0375	0278 + 0294
0207 + 0375	0279 + 0294
Referencias	Referencias
0314 + 0314	0296 + 0296
0315 + 0314	0297 + 0296
0316 + 0314	0298 + 0296
0201 + 0314	0273 + 0296
0317 + 0314	0299 + 0296
0203 + 0314	0275 + 0296
0204 + 0314	0276 + 0296
0205 + 0314	0277 + 0296
0206 + 0314	0278 + 0296
0207 + 0314	0279 + 0296
Referencias	Referencias
0315 + 0315	0297 + 0297
0316 + 0315	0298 + 0297
0201 + 0315	0273 + 0297
0317 + 0315	0299 + 0297
0203 + 0315	0275 + 0297
0204 + 0315	0276 + 0297
0205 + 0315	0277 + 0297
0206 + 0315	0278 + 0297
0207 + 0315	0279 + 0297

También se pueden obtener combinaciones con lados de 100 y 120

Referencias	Descripción
0218	perfil compensación +2 cm
0029	perfil compensación +4 cm

Prestige Titan

frontal + lateral fijo 8 mm



Referencias	Descripción	Rangos (min-max)
0810	lateral fijo STD 8 mm 30x195	26 - 29
0811	lateral fijo STD 8 mm 40x195	36 - 39
0812	lateral fijo STD 8 mm 50x195	46 - 49
0813	lateral fijo STD 8 mm 60x195	56 - 59
0814	lateral fijo STD 8 mm 70x195	66 - 69
0820	lateral fijo STD 8 mm 75x195	71 - 74
0815	lateral fijo STD 8 mm 80x195	76 - 79
0816	lateral fijo STD 8 mm 90x195	86 - 89
0817	lateral fijo STD 8 mm FROST PLUS 70	66 - 69
0818	lateral fijo STD 8 mm FROST PLUS 80	76 - 79
0819	lateral fijo STD 8 mm FROST PLUS 90	86 - 89

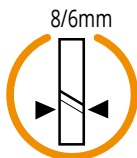
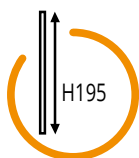

PRESTIGE TITAN + lateral fijo de 8 mm



cierre imán oculto



rodamiento rfzdo. doble



pulsador liberador

Medidas	Rangos	Apert.
100x70	97,4-100,4 / 66-69	38
110x70	107,4-110,4 / 66-69	43
120x70	117,4-120,4 / 66-69	48
130x70	127,4-130,4 / 66-69	53
140x70	137,4-140,4 / 66-69	58
150x70	147,4-150,4 / 66-69	53
160x70	157,4-160,4 / 66-69	58
170x70	167,4-170,4 / 66-69	63

Medidas	Rangos	Apert.
100x80	97,4-100,4 / 76-79	38
110x80	107,4-110,4 / 76-79	43
120x80	117,4-120,4 / 76-79	48
130x80	127,4-130,4 / 76-79	53
140x80	137,4-140,4 / 76-79	58
150x80	147,4-150,4 / 76-79	53
160x80	157,4-160,4 / 76-79	58
170x80	167,4-170,4 / 76-79	63

Medidas	Rangos	Apert.
100x90	97,4-100,4 / 86-89	38
110x90	107,4-110,4 / 86-89	43
120x90	117,4-120,4 / 86-89	48
130x90	127,4-130,4 / 86-89	53
140x90	137,4-140,4 / 86-89	58
150x90	147,4-150,4 / 86-89	53
160x90	157,4-160,4 / 86-89	58
170x90	167,4-170,4 / 86-89	63

TRANSPARENTE	FROST PLUS
Referencias	Referencias
0200 + 0814	0272 + 0817
0201 + 0814	0273 + 0817
0202 + 0814	0274 + 0817
0203 + 0814	0275 + 0817
0204 + 0814	0276 + 0817
0205 + 0814	0277 + 0817
0206 + 0814	0278 + 0817
0207 + 0814	0279 + 0817
Referencias	Referencias
0200 + 0815	0272 + 0818
0201 + 0815	0273 + 0818
0202 + 0815	0274 + 0818
0203 + 0815	0275 + 0818
0204 + 0815	0276 + 0818
0205 + 0815	0277 + 0818
0206 + 0815	0278 + 0818
0207 + 0815	0279 + 0818
Referencias	Referencias
0200 + 0816	0272 + 0819
0201 + 0816	0273 + 0819
0202 + 0816	0274 + 0819
0203 + 0816	0275 + 0819
0204 + 0816	0276 + 0819
0205 + 0816	0277 + 0819
0206 + 0816	0278 + 0819
0207 + 0816	0279 + 0819

*Se pueden hacer otras combinaciones con medidas intermedias de frontales

Referencias	Descripción
0218	perfil compensación +2 cm
0029	perfil compensación +4 cm
0219	perfil compensación (+ 5,5 cm)



Laterales fijos a medida	TRANSPARENTE	FROST PLUS
	Ref.	Ref.
lateral fijo a medida hasta 40 cm	1343	1343+1312
lateral fijo a medida de 40 hasta 80 cm	1304	1304+1313
lateral fijo a medida de 80 hasta 120 cm	1310	1310+1315

*Plazo de entrega 15 días (más información en página 259)

aktual

Evolución Prestige sin perflería inferior

Mampara de aluminio con cristales fijos de 8 mm y hojas correderas de 6 mm.

El modelo Aktual está disponible en todas las medidas y formatos en cristal transparente o frost plus.

El modelo Aktual destaca por su perflería minimalista de líneas rectas y la ausencia de perflería inferior siguiendo las últimas tendencias del mercado, así como por su innovador sistema de cierre con magnético oculto.

Este modelo incluye tratamiento antical de serie.

NOVEDADES Y MEJORAS:

Rodamientos con antivuelco

Vierteaguas y gomas 100% silic. transparentes





aktual 1 fijo+1 corredera



cierre imán oculto



doble rodamiento antivuelco

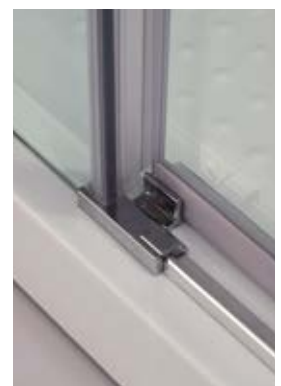

vierteaguas metálico

AKTUAL 1 fijo+1 corredera

Referencias	Descripción	Apertura	Rangos
0280	AKTUAL 1 fijo+1 corredera 100X195	38	97 - 103
0281	AKTUAL 1 fijo+1 corredera 110X195	43	107 - 113
0282	AKTUAL 1 fijo+1 corredera 120X195	48	117 - 123
0283	AKTUAL 1 fijo+1 corredera 130X195	53	127 - 133
0284	AKTUAL 1 fijo+1 corredera 140X195	58	137 - 143
0285	AKTUAL 1 fijo+1 corredera 150X195	63	147 - 153
0286	AKTUAL 1 fijo+1 corredera 160X195	58	157 - 163
0287	AKTUAL 1 fijo+1 corredera 170X195	63	167 - 173
0218	perfil compensación +2 cm		
0029	perfil compensación +4 cm		

aktual frost plus 1 fijo+1 corredera

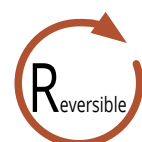
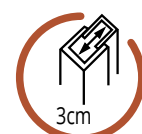
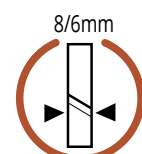

AKTUAL FROST PLUS 1 fijo+1 corredera

Referencias	Descripción	Apertura	Rangos
0580	AKTUAL FROST PLUS 1 fijo+1 corredera 100X195	38	97 - 103
0581	AKTUAL FROST PLUS 1 fijo+1 corredera 110X195	43	107 - 113
0582	AKTUAL FROST PLUS 1 fijo+1 corredera 120X195	48	117 - 123
0583	AKTUAL FROST PLUS 1 fijo+1 corredera 130X195	53	127 - 133
0584	AKTUAL FROST PLUS 1 fijo+1 corredera 140X195	58	137 - 143
0585	AKTUAL FROST PLUS 1 fijo+1 corredera 150X195	63	147 - 153
0586	AKTUAL FROST PLUS 1 fijo+1 corredera 160X195	58	157 - 163
0587	AKTUAL FROST PLUS 1 fijo+1 corredera 170X195	63	167 - 173
0218	perfil compensación +2 cm		
0029	perfil compensación +4 cm		

aktual spazio 2fijos+2correderas



tirador



doble rodamiento antivuelco



vierteaguas metálico

AKTUAL SPAZIO 2fijos+2correderas

Referencias	Descripción	Apertura	Rangos
0570	AKTUAL SPAZIO 2fijos+2correderas 140X195	53	136 - 142
0571	AKTUAL SPAZIO 2fijos+2correderas 150X195	58	146 - 152
0572	AKTUAL SPAZIO 2fijos+2correderas 160X195	63	156 - 162
0573	AKTUAL SPAZIO 2fijos+2correderas 170X195	68	166 - 172
0574	AKTUAL SPAZIO 2fijos+2correderas 180X195	73	176 - 182
0575	AKTUAL SPAZIO 2fijos+2correderas 190X195	78	186 - 192
0218	perfil compensación +2 cm		
0029	perfil compensación +4 cm		

*Se puede combinar con el lateral fijo STD (ver pág. 70), el rango aumenta en 0,7 y se pierde la expansión en el lado dónde se instala el fijo.

aktual spazio frost plus ^{2f+2c}

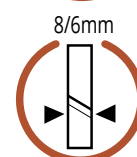
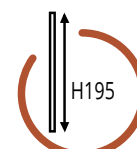

AKTUAL SPAZIO FROST PLUS 2fijos+2correderas

Referencias	Descripción	Apertura	Rangos
0588	AKTUAL SPAZIO FROST PLUS 2fijos+2correderas 140X195	53	136 - 142
0589	AKTUAL SPAZIO FROST PLUS 2fijos+2correderas 150X195	58	146 - 152
0590	AKTUAL SPAZIO FROST PLUS 2fijos+2correderas 160X195	63	156 - 162
0591	AKTUAL SPAZIO FROST PLUS 2fijos+2correderas 170X195	68	166 - 172
0592	AKTUAL SPAZIO FROST PLUS 2fijos+2correderas 180X195	73	176 - 182
0593	AKTUAL SPAZIO FROST PLUS 2fijos+2correderas 190X195	78	186 - 192
0218	perfil compensación +2 cm		
0029	perfil compensación +4 cm		

*Se puede combinar con el lateral fijo STD Frost Plus (ver pág. 70), el rango aumenta en 0,7 y se pierde la expansión en el lado dónde se instala el fijo.

aktual angular al vértice



Descripción	TRANSPARENTE	FROST PLUS
	Ref.	Ref.
lado 70x195 AKTUAL 1fijo+1corredera	0320	0595
lado 80x195 AKTUAL 1fijo+1corredera	0321	0596
lado 90x195 AKTUAL 1fijo+1corredera	0322	0597
lado 100x195 AKTUAL 1fijo+1corredera	0323	0598
lado 120x195 AKTUAL 1fijo+1corredera	0324	0599

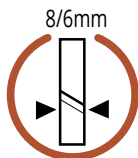
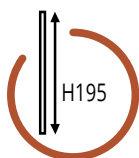

combinaciones angular **AKTUAL** al vértice



tirador



doble rodamiento antivuelco



vierteaguas metálico

Medida	Rangos	Apert.
70x70	67-70 / 67-70	33
80x70	77-80 / 67-70	37
90x70	87-90 / 67-70	41
100x70	97-100 / 67-70	45
110x70	104-107 / 67-70	47
120x70	117-120 / 67-70	50
130x70	124-127 / 67-70	56
140x70	134-137 / 67-70	60
150x70	144-147 / 67-70	64

Medida	Rangos	Apert.
80x80	77-80 / 77-80	40
90x80	87-90 / 77-80	44
100x80	97-100 / 77-80	48
110x80	104-107 / 77-80	50
120x80	117-120 / 77-80	52
130x80	124-127 / 77-80	58
140x80	134-137 / 77-80	62
150x80	144-147 / 77-80	66

Medida	Rangos	Apert.
90x90	87-90 / 87-90	47
100x90	97-100 / 87-90	51
110x90	104-107 / 87-90	53
120x90	117-120 / 87-90	55
130x90	124-127 / 87-90	60
140x90	134-137 / 87-90	64
150x90	144-147 / 87-90	68

TRANSPARENTE	FROST PLUS
Referencias	Referencias
0320 + 0320	0595 + 0595
0321 + 0320	0596 + 0595
0322 + 0320	0597 + 0595
0323 + 0320	0598 + 0595
0281 + 0320	0581 + 0595
0324 + 0320	0599 + 0595
0283 + 0320	0583 + 0595
0284 + 0320	0584 + 0595
0285 + 0320	0585 + 0595
Referencias	Referencias
0321 + 0321	0596 + 0596
0322 + 0321	0597 + 0596
0323 + 0321	0598 + 0596
0281 + 0321	0581 + 0596
0324 + 0321	0599 + 0596
0283 + 0321	0583 + 0596
0284 + 0321	0584 + 0596
0285 + 0321	0585 + 0596
Referencias	Referencias
0322 + 0322	0597 + 0597
0323 + 0322	0598 + 0597
0281 + 0322	0581 + 0597
0324 + 0322	0599 + 0597
0283 + 0322	0583 + 0597
0284 + 0322	0584 + 0597
0285 + 0322	0585 + 0597

También se pueden obtener combinaciones con lados de 100 y 120

Referencias	Descripción
0218	perfil compensación +2 cm
0029	perfil compensación +4 cm

aktual frontal + lateral fijo STD 8 mm



Referencias	Descripción	Rangos (min-max)
0810	lateral fijo STD 8 mm 30	26 - 29
0811	lateral fijo STD 8 mm 40	36 - 39
0812	lateral fijo STD 8 mm 50	46 - 49
0813	lateral fijo STD 8 mm 60	56 - 59
0814	lateral fijo STD 8 mm 70	66 - 69
0820	lateral fijo STD 8 mm 75	71 - 74
0815	lateral fijo STD 8 mm 80	76 - 79
0816	lateral fijo STD 8 mm 90	86 - 89
0817	lateral fijo STD 8 mm FROST PLUS 70	66 - 69
0818	lateral fijo STD 8 mm FROST PLUS 80	76 - 79
0819	lateral fijo STD 8 mm FROST PLUS 90	86 - 89

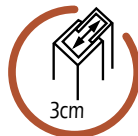
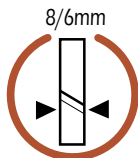
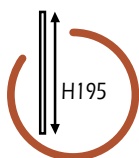

cierre imán oculto



doble rodamiento antivuelco



vierteaguas metálico

AKTUAL + lateral fijo de 8 mm

Medidas	Rangos	Apert.	TRANSPARENTE	FROST PLUS
			Referencias	Referencias
100x70	97,4-100,4 / 66-69	38	0280 + 0814	0580 + 0817
110x70	107,4-110,4 / 66-69	43	0281 + 0814	0581 + 0817
120x70	117,4-120,4 / 66-69	48	0282 + 0814	0582 + 0817
130x70	127,4-130,4 / 66-69	53	0283 + 0814	0583 + 0817
140x70	137,4-140,4 / 66-69	58	0284 + 0814	0584 + 0817
150x70	147,4-150,4 / 66-69	53	0285 + 0814	0585 + 0817
160x70	157,4-160,4 / 66-69	58	0286 + 0814	0586 + 0817
170x70	167,4-170,4 / 66-69	63	0287 + 0814	0587 + 0817
Medidas	Rangos	Apert.	Referencias	Referencias
100x80	97,4-100,4 / 76-79	38	0280 + 0815	0580 + 0818
110x80	107,4-110,4 / 76-79	43	0281 + 0815	0581 + 0818
120x80	117,4-120,4 / 76-79	48	0282 + 0815	0582 + 0818
130x80	127,4-130,4 / 76-79	53	0283 + 0815	0583 + 0818
140x80	137,4-140,4 / 76-79	58	0284 + 0815	0584 + 0818
150x80	147,4-150,4 / 76-79	53	0285 + 0815	0585 + 0818
160x80	157,4-160,4 / 76-79	58	0286 + 0815	0586 + 0818
170x80	167,4-170,4 / 76-79	63	0287 + 0815	0587 + 0818
Medidas	Rangos	Apert.	Referencias	Referencias
100x90	97,4-100,4 / 86-89	38	0280 + 0816	0580 + 0819
110x90	107,4-110,4 / 86-89	43	0281 + 0816	0581 + 0819
120x90	117,4-120,4 / 86-89	48	0282 + 0816	0582 + 0819
130x90	127,4-130,4 / 86-89	53	0283 + 0816	0583 + 0819
140x90	137,4-140,4 / 86-89	58	0284 + 0816	0584 + 0819
150x90	147,4-150,4 / 86-89	53	0285 + 0816	0585 + 0819
160x90	157,4-160,4 / 86-89	58	0286 + 0816	0586 + 0819
170x90	167,4-170,4 / 86-89	63	0287 + 0816	0587 + 0819

*Se pueden hacer otras combinaciones con medidas intermedias de frontales

Referencias	Descripción
0218	perfil compensación +2 cm
0029	perfil compensación +4 cm
0219	perfil compensación (+ 5,5 cm)



Laterales fijos a medida AKTUAL	TRANSPARENTE	FROST PLUS
Descripción	Ref.	Ref.
lateral fijo a medida hasta 40 cm	1343	1343+1312
lateral fijo a medida de 40 hasta 80 cm	1304	1304+1313
lateral fijo a medida de 80 hasta 120 cm	1310	1310+1315

*Plazo de entrega 15 días. Más información en página 259

GME

VETRUM pg.74

TEMPLE pg.86



ROTARY pg.94

FUTURA pg.102

MOVING pg.112



**MAMPARAS
ACERO
CORREDERAS**

vetrum

INOX

En la Vanguardia del diseño

Mampara de acero inoxidable con cristales fijos de 10mm y hojas correderas de 8mm.

El modelo Vetrum está disponible en todas las medidas y formatos.

El modelo Vetrum destaca por su diseño vanguardista y su sistema innovador de apertura, la hoja corre sobre una guía inferior de acero inoxidable y sobre el interior del cristal en la parte superior, evitando así el uso de perfilierías superior e inferior.

NOVEDAD:

Tratamiento antical de serie





vetrum free 1 fijo + 1 corredera



Referencias

Descripción

1071

freno vetrum free

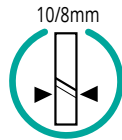
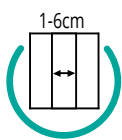
frontales **VETRUM FREE**

Referencias	Descripción	Rango
1070 + 1071	frontal ducha VETRUM FREE 115	111 - 116
1050 + 1071	frontal ducha VETRUM FREE 120	115 - 120
1051 + 1071	frontal ducha VETRUM FREE 125	120 - 125
1052 + 1071	frontal ducha VETRUM FREE 130	125 - 130
1053 + 1071	frontal ducha VETRUM FREE 135	130 - 135
1054 + 1071	frontal ducha VETRUM FREE 140	135 - 140
1055 + 1071	frontal ducha VETRUM FREE 145	140 - 145
1056 + 1071	frontal ducha VETRUM FREE 150	145 - 150
1057 + 1071	frontal ducha VETRUM FREE 155	150 - 155
1058 + 1071	frontal ducha VETRUM FREE 160	155 - 160
1059 + 1071	frontal ducha VETRUM FREE 165	160 - 165
1060 + 1071	frontal ducha VETRUM FREE 170	165 - 170
1061 + 1071	frontal ducha VETRUM FREE 175	170 - 175
1062 + 1071	frontal ducha VETRUM FREE 180	175 - 180
1073	Perfil expansión (+1 cm)	



rodamiento acero integrado



barra acero ext. 108 cm y orientable



freno de corredera

vetrum 1 fijo + 1 corredera

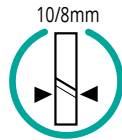
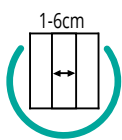

frontales **VETRUM** 1fijo+1corredera

Referencias	Descripción	Apertura	Rango
1070	frontal ducha VETRUM 115	39,7 - 44,3	113 - 118
1050	frontal ducha VETRUM 120	40,7 - 45,7	117 - 122
1051	frontal ducha VETRUM 125	40,7 - 45,7	122 - 127
1052	frontal ducha VETRUM 130	45,7 - 50,7	127 - 132
1053	frontal ducha VETRUM 135	45,7 - 50,7	132 - 137
1054	frontal ducha VETRUM 140	50,7 - 55,7	137 - 142
1055	frontal ducha VETRUM 145	50,7 - 55,7	142 - 147
1056	frontal ducha VETRUM 150	55,7 - 60,7	147 - 152
1057	frontal ducha VETRUM 155	55,7 - 60,7	152 - 157
1058	frontal ducha VETRUM 160	60,7 - 65,7	157 - 162
1059	frontal ducha VETRUM 165	60,7 - 65,7	162 - 167
1060	frontal ducha VETRUM 170	65,7 - 70,7	167 - 172
1061	frontal ducha VETRUM 175	60,7 - 65,7	172 - 177
1062	frontal ducha VETRUM 180	65,7 - 70,7	177 - 182
1073	Perfil expansión +1 cm		
1072	Opción cierre perfil inox + burbuja *Con este sistema el rango se reduce 2 cm		
5546	Opción barra inox paralela hasta 2 m		



Guía y rodamiento inferior en acero



Rodamiento acero integrado



Opción barra paralela

vetrum spazio 2fijos + 2correderas



Referencias

Descripción

1071

Kit conversión spazio

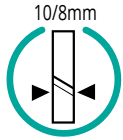
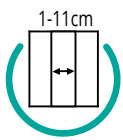
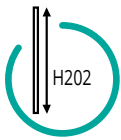

frontales VETRUM 2fijos+2correderas

Referencias	Descripción	Apertura	Rango
1067+1067+1071	VETRUM SPAZIO 2fijos+2correderas 150x202	30 - 50	134 - 154
1068+1068+1071	VETRUM SPAZIO 2fijos+2correderas 170x202	40 - 60	154 - 174
1069+1069+1071	VETRUM SPAZIO 2fijos+2correderas 190x202	50 - 70	174 - 194
1070+1070+1071	VETRUM SPAZIO 2fijos+2correderas 210x202	69 - 89	213 - 233
1073	Perfil expansión +1 cm		



guía y rodamiento inferior en acero



rodamiento acero integrado



barra acero ext. 108 cm y orientable

vetrum angular al vértice

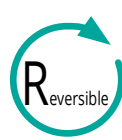
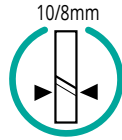
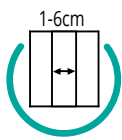
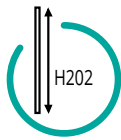

Referencias	Descripción
1066	lado VETRUM 70 1 fijo+1 corredera
1067	lado VETRUM 80 1 fijo+1 corredera
1068	lado VETRUM 90 1 fijo+1 corredera
1069	lado VETRUM 100 1 fijo+1 corredera
1070	lado VETRUM 120 1 fijo+1 corredera

combinaciones angular **VETRUM** apertura al vértice

Medidas	Referencias	Apertura	Rangos
70x70	1066+1066	26 - 29	65-70/65-70
80x70	1067+1066	29 - 32	75-80/65-70
90x70	1068+1066	33 - 36	85-90/65-70
100x70	1069+1066	37 - 40	95-100/65-70
115x70	1070+1066	44 - 49	114-119/65-70
120x70	1050+1066	44 - 49	118-123/65-70
125x70	1051+1066	45 - 50	123-128/65-70
130x70	1052+1066	49 - 54	128-133/65-70
135x70	1053+1066	49 - 54	133-138/65-70
140x70	1054+1066	55 - 60	138-143/65-70
145x70	1055+1066	55 - 60	143-148/65-70
150x70	1056+1066	59 - 64	148-153/65-70
Medidas	Referencias	Apertura	Rangos
70x80	1066+1067	29 - 32	65-70/75-80
80x80	1067+1067	33 - 36	75-80/ 75-80
90x80	1068+1067	36 - 39	85-90/75-80
100x80	1069+1067	40 - 43	95-100/75-80
115x80	1070+1067	46 - 51	114-119/75-80
120x80	1050+1067	46 - 51	118-123/75-80
125x80	1051+1067	47 - 52	123-128/75-80
130x80	1052+1067	51 - 56	128-133/75-80
135x80	1053+1067	51 - 56	133-138/75-80
140x80	1054+1067	56 - 61	138-143/75-80
145x80	1055+1067	56 - 61	143-148/75-80
150x80	1056+1067	60 - 65	148-153/75-80
Medidas	Referencias	Apertura	Rangos
90x90	1068+1068	40 - 43	85-90/85-90
100x90	1069+1068	43 - 46	95-100/85-90
115x90	1070+1068	51 - 54	114-119/85-90
120x90	1050+1068	51 - 54	118-123/85-90
125x90	1051+1068	50 - 55	123-128/85-90
130x90	1052+1068	54 - 59	128-133/85-90
135x90	1053+1068	54 - 59	133-138/85-90
140x90	1054+1068	58 - 63	138-143/85-90
145x90	1055+1068	58 - 63	143-148/85-90
150x90	1056+1068	63 - 68	148-153/85-90
1073	Perfil expansión (+1 cm)		

vetrum frontal + lateral fijo



Referencias	Descripción	Rango
1063	lateral fijo 70 VETRUM 10 mm + brazo	67 - 69
1115	lateral fijo 75 VETRUM 10 mm + brazo	72 - 74
1064	lateral fijo 80 VETRUM 10 mm + brazo	77 - 79
1065	lateral fijo 90 VETRUM 10 mm + brazo	87 - 89

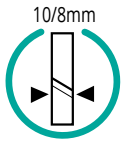
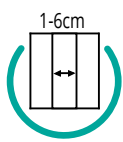
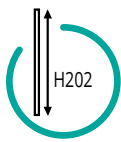

combinaciones VETRUM frontal + lateral fijo

Medidas	Referencias	Rango	Medidas	Referencias	Rango
115x70	1070 +1063	113-117 / 67-69	115x75	1070 + 1115	113-117 / 72-74
120x70	1050 +1063	116-121 / 67-69	120x75	1050 + 1115	116-121 / 72-74
125x70	1051 +1063	121-126 / 67-69	125x75	1051 + 1115	121-126 / 72-74
130x70	1052 +1063	126-131 / 67-69	130x75	1052 + 1115	126-131 / 72-74
135x70	1053 +1063	131-136 / 67-69	135x75	1053 + 1115	131-136 / 72-74
140x70	1054 +1063	136-141 / 67-69	140x75	1054 + 1115	136-141 / 72-74
145x70	1055 +1063	141-146 / 67-69	145x75	1055 + 1115	141-146 / 72-74
150x70	1056 +1063	146-151 / 67-69	150x75	1056 + 1115	146-151 / 72-74
155x70	1057 +1063	151-156 / 67-69	155x75	1057 + 1115	151-156 / 72-74
160x70	1058 +1063	156-161 / 67-69	160x75	1058 + 1115	156-161 / 72-74
165x70	1059 +1063	161-166 / 67-69	165x75	1059 + 1115	161-166 / 72-74
170x70	1060 +1063	166-171 / 67-69	170x75	1060 + 1115	166-171 / 72-74
175x70	1061 +1063	171-176 / 67-69	175x75	1061 + 1115	171-176 / 72-74
180x70	1062 +1063	176-181 / 67-69	180x75	1062 + 1115	176-181 / 72-74

Medidas	Referencias	Rango	Medidas	Referencias	Rango
115x80	1070 + 1064	113-117 / 77-79	115x90	1070 + 1065	113-117 / 87-89
120x80	1050 +1064	116-121 / 77-79	120x90	1050 +1065	116-121 / 87-89
125x80	1051 +1064	121-126 / 77-79	125x90	1051 +1065	121-126 / 87-89
130x80	1052 +1064	126-131 / 77-79	130x90	1052 +1065	126-131 / 87-89
135x80	1053 +1064	131-136 / 77-79	135x90	1053 +1065	131-136 / 87-89
140x80	1054 +1064	136-141 / 77-79	140x90	1054 +1065	136-141 / 87-89
145x80	1055 +1064	141-146 / 77-79	145x90	1055 +1065	141-146 / 87-89
150x80	1056 +1064	146-151 / 77-79	150x90	1056 +1065	146-151 / 87-89
155x80	1057 +1064	151-156 / 77-79	155x90	1057 +1065	151-156 / 87-89
160x80	1058 +1064	156-161 / 77-79	160x90	1058 +1065	156-161 / 87-89
165x80	1059 +1064	161-166 / 77-79	165x90	1059 +1065	161-166 / 87-89
170x80	1060 +1064	166-171 / 77-79	170x90	1060 +1065	166-171 / 87-89
175x80	1061 +1064	171-176 / 77-79	175x90	1061 +1065	171-176 / 87-89
180x80	1062 +1064	176-181 / 77-79	180x90	1062 +1065	176-181 / 87-89

1073 perfil expansión +1 cm

*Las aperturas son las mismas que en los frontales.

Laterales fijos a medida (más información en página 259)



Referencias	Descripción
1340	lateral fijo a medida VETRUM hasta 40 cm
1300	lateral fijo a medida VETRUM de 40 hasta 80 cm
1306	lateral fijo a medida VETRUM de 80 hasta 120 cm
1075	opción perfil unión fijo + lateral fijo (ver pág. 260)

*Plazo de entrega 15 días

temple

INOX

La nobleza del Acero al alcance de todos.

Mampara de acero inoxidable con cristales de 6 mm.
El modelo Temple está disponible en todas las medidas en formatos frontal, angular al vértice y angular con lateral fijo de 8 mm.

Temple destaca por su barra de acero inoxidable en líneas rectas siguiendo las últimas tendencias del mercado, así como su precio asequible.

También es de destacar su innovador pulsador liberador de hoja en el guiador para facilitar su limpieza.

Este modelo incluye tratamiento antical de serie.

NOVEDADES Y MEJORAS:

Guiador optimizado

Reducción de espacio entre cristales

Vierteaguas y gomas 100% silic. transparentes

Laterales fijos de 75 cm.





temple 1 fijo + 1 corredera



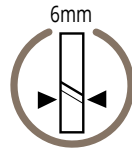
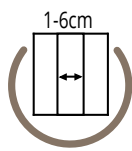
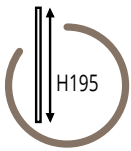

frontales **TEMPLE** 1fijo+1corredera

Medida	Apertura	TRANSPARENTE	FROST PLUS
		Ref.	Ref.
95-100	36 - 41	5101	6101
100-105	36 - 41	5102	6102
105-110	41 - 46	5103	6103
110-115	41 - 46	5104	6104
115-120	46 - 51	5105	6105
120-125	46 - 51	5106	6106
125-130	51 - 56	5107	6107
130-135	51 - 56	5108	6108
135-140	56 - 61	5109	6109
140-145	56 - 61	5110	6110
145-150	61 - 66	5111	6111
150-155	61 - 66	5112	6112
155-160	61 - 66	5113	6113
160-165	61 - 66	5114	6114
165-170	66 - 71	5115	6115
170-175	61 - 66	5116	6116
175-180	66 - 71	5117	6117
5179	perfil de compensación para parte fija + 1,5 cm		
0008	pletina embellecedora 195x3,8cm		



Nuevo guiador optimizado con pulsador liberador de hoja para facilitar la limpieza



Perfilería de acero inoxidable con guía interna en aluminio

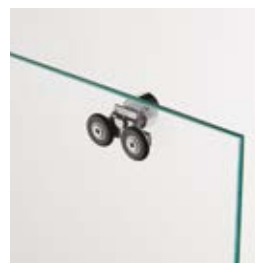

Doble rodamiento última generación nylon



Opción tirador	Ref.
Extraplano 22x1,6x0,7 cm	1731
Largo 40x1,2x1,5 cm	1732



Mamparas a medida y cristales especiales	TRANSPARENTE	FROST PLUS / PARSOL CARGLASS / MATE
Altura hasta 195 cm	+45%	+55%

*Plazo de entrega 15 días (más información en pág. 258)

temple angular al vértice



Descripción	TRANSPARENTE	FROST PLUS
	Ref.	Ref.
lado TEMPLE 70 1fijo+1corredera	5118	6118
lado TEMPLE 75 1fijo+1corredera	5129	6129
lado TEMPLE 80 1fijo+1corredera	5119	6119
lado TEMPLE 90 1fijo+1corredera	5120	6120
lado TEMPLE 100 1fijo+1corredera	5121	6121
lado TEMPLE 120 1fijo+1corredera	5122	6122
corner kit unión lado + lado	5123	
corner kit unión frontal + lado	5124	

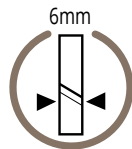
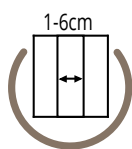
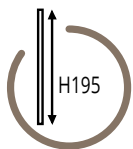

combinaciones angular **TEMPLE** apertura al vértice

Medida	Rangos	Apert.
70x70	65-70 / 65-70	34 - 37
75x70	70-75 / 65-70	36 - 39
80x70	75-80 / 65-70	38 - 41
90x70	85-90 / 65-70	42 - 45
100x70	95-100 / 65-70	46 - 49
110x70	104-109 / 65-70	47 - 50
120x70	115-120 / 65-70	50 - 53
130x70	125-129 / 65-70	55 - 58
140x70	135-139 / 65-70	59 - 62
Medida	Rangos	Apert.
75x75	70-75 / 70-75	38 - 41
80x75	75-80 / 70-75	40 - 43
90x75	85-90 / 70-75	45 - 48
100x75	95-100 / 70-75	48 - 51
110x75	104-109 / 70-75	49 - 52
120x75	115-120 / 70-75	52 - 55
130x75	125-129 / 70-75	57 - 60
140x75	135-139 / 70-75	61 - 64
Medida	Rangos	Apert.
80x80	75-80 / 75-80	41 - 44
90x80	85-90 / 75-80	45 - 48
100x80	95-100 / 75-80	49 - 52
110x80	104-109 / 75-80	50 - 53
120x80	115-120 / 75-80	53 - 56
130x80	125-129 / 75-80	57 - 61
140x80	135-139 / 75-80	62 - 65
Medida	Rangos	Apert.
90x90	85-90 / 85-90	48 - 51
100x90	95-100 / 85-90	52 - 55
110x90	104-109 / 85-90	53 - 56
120x90	115-120 / 85-90	55 - 58
130x90	125-129 / 85-90	61 - 63
140x90	135-139 / 85-90	64 - 67

TRANSPARENTE	FROST PLUS
Referencias	Referencias
5118+5118+5123	6118+6118+5123
5129+5118+5123	6129+6118+5123
5119+5118+5123	6119+6118+5123
5120+5118+5123	6120+6118+5123
5121+5118+5123	6121+6118+5123
5102+5118+5124	6102+6118+5124
5122+5118+5123	6122+6118+5123
5106+5118+5124	6106+6118+5124
5108+5118+5124	6108+6118+5124
Referencias	Referencias
5129+5129+5123	6129+6129+5123
5119+5129+5123	6119+6129+5123
5120+5129+5123	6120+6129+5123
5121+5129+5123	6121+6129+5123
5102+5129+5124	6102+6129+5124
5122+5129+5123	6122+6129+5123
5106+5129+5124	6106+6129+5124
5108+5129+5124	6108+6129+5124
Referencias	Referencias
5119+5119+5123	6119+6119+5123
5120+5119+5123	6120+6119+5123
5121+5119+5123	6121+6119+5123
5102+5119+5124	6102+6119+5124
5122+5119+5123	6122+6119+5123
5106+5119+5124	6106+6119+5124
5108+5119+5124	6108+6119+5124
Referencias	Referencias
5120+5120+5123	6120+6120+5123
5121+5120+5123	6121+6120+5123
5102+5120+5124	6102+6120+5124
5122+5120+5123	6122+6120+5123
5106+5120+5124	6106+6120+5124
5108+5120+5124	6108+6120+5124

*Se pueden combinar medidas intermedias. El rango resultante aumenta 4 cm respecto al rango del frontal

Referencias	Descripción
5179	perfil de compensación +1,5 cm



Mamparas a medida y cristales especiales	TRANSPARENTE	FROST PLUS / PARSOL CARGLASS / MATE
Altura hasta 195 cm	+45%	+55%

*Plazo de entrega 15 días (más información en pág. 258)

temple frontal + lateral fijo de 8 mm



Descripción	Rango	TRANSPARENTE	FROST PLUS
		Ref.	Ref.
lateral fijo TEMPLE 70	67 - 69	5125	6125
lateral fijo TEMPLE 75	72 - 74	5157	6157
lateral fijo TEMPLE 80	77 - 79	5126	6126
lateral fijo TEMPLE 90	87 - 89	5127	6127



Laterales fijos a medida

Descripción

lateral fijo a medida hasta 40 cm
lateral fijo a medida de 40 hasta 80 cm
lateral fijo a medida de 80 hasta 120 cm

TRANSPARENTE

Ref.

1349
1302
1308

FROST PLUS

Ref.

1349+1312
1302+1313
1308+1315

*Plazo de entrega 15 días (más información en página 259)

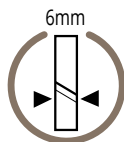
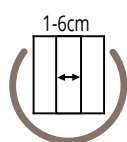

frontales + lateral fijo de 8 mm

		TRANSPARENTE	FROST PLUS
Medidas	Rangos	Referencias	Referencias
100x70	95-100/67-69	5101+5125	6101+6125
110x70	105-110/67-69	5103+5125	6103+6125
120x70	115-120/67-69	5105+5125	6105+6125
130x70	125-130/67-69	5107+5125	6107+6125
140x70	135-140/67-69	5109+5125	6109+6125
150x70	145-150/67-69	5111+5125	6111+6125
160x70	155-160/67-69	5113+5125	6113+6125
170x70	165-170/67-69	5115+5125	6115+6125
180x70	175-180/67-69	5117+5125	6117+6125
Medidas	Rangos	Referencias	Referencias
100x75	95-100/72-74	5101+5157	6101+6157
110x75	105-110/72-74	5103+5157	6103+6157
120x75	115-120/72-74	5105+5157	6105+6157
130x75	125-130/72-74	5107+5157	6107+6157
140x75	135-140/72-74	5109+5157	6109+6157
150x75	145-150/72-74	5111+5157	6111+6157
160x75	155-160/72-74	5113+5157	6113+6157
170x75	165-170/72-74	5115+5157	6115+6157
180x75	175-180/72-74	5117+5157	6117+6157
Medidas	Rangos	Referencias	Referencias
100x80	95-100/77-79	5101+5126	6101+6126
110x80	105-110/77-79	5103+5126	6103+6126
120x80	115-120/77-79	5105+5126	6105+6126
130x80	125-130/77-79	5107+5126	6107+6126
140x80	135-140/77-79	5109+5126	6109+6126
150x80	145-150/77-79	5111+5126	6111+6126
160x80	155-160/77-79	5113+5126	6113+6126
170x80	165-170/77-79	5115+5126	6115+6126
180x80	175-180/77-79	5117+5126	6117+6126
Medidas	Rangos	Referencias	Referencias
100x90	95-100/87-89	5101+5127	6101+6127
110x90	105-110/87-89	5103+5127	6103+6127
120x90	115-120/87-89	5105+5127	6105+6127
130x90	125-130/87-89	5107+5127	6107+6127
140x90	135-140/87-89	5109+5127	6109+6127
150x90	145-150/87-89	5111+5127	6111+6127
160x90	155-160/87-89	5113+5127	6113+6127
170x90	165-170/87-89	5115+5127	6115+6127
180x90	175-180/87-89	5117+5127	6117+6127

*Se pueden hacer otras combinaciones con medidas intermedias de frontales

Referencias	Descripción
5179	perfil de compensación +1,5 cm (sólo válido para frontal)
1075	perfil unión fijo - fijo (más información pág. 260)

rotary

INOX

Elegante combinación de líneas

Mampara de acero inoxidable con cristales de 6 mm.
El modelo Rotary está disponible en todas las medidas en formatos frontal, angular al vértice y angular con lateral fijo de 8 mm.

Destaca por su elegante combinación de líneas rectas y circulares, así como su innovador pulsador liberador de hoja en el guiador para facilitar su limpieza.

Este modelo incluye tratamiento anticorrosión de serie.

NOVEDADES Y MEJORAS:

Guiador optimizado

Reducción de espacio entre cristales

Vierteaguas y gomas 100% silic. transparentes

Laterales fijos de 75 cm.





ACERO

rotary 1 fijo + 1 corredera



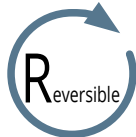
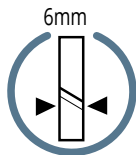
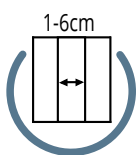

frontales **ROTARY** 1 fijo+1 corredera

Medida	Apertura	TRANSPARENTE	FROST PLUS
		Ref.	Ref.
95-100	36 - 41	5201	6201
100-105	36 - 41	5202	6202
105-110	41 - 46	5203	6203
110-115	41 - 46	5204	6204
115-120	46 - 51	5205	6205
120-125	46 - 51	5206	6206
125-130	51 - 56	5207	6207
130-135	51 - 56	5208	6208
135-140	56 - 61	5209	6209
140-145	56 - 61	5210	6210
145-150	61 - 66	5211	6211
150-155	61 - 66	5212	6212
155-160	61 - 66	5213	6213
160-165	61 - 66	5214	6214
165-170	66 - 71	5215	6215
170-175	61 - 66	5216	6216
175-180	66 - 71	5217	6217

5179 perfil de compensación para parte fija + 1,5 cm

0008 pletina embellecedora 195x3,8 cm



Nuevo guía optimizado con pulsador liberador de hoja para facilitar la limpieza



Innovador rodamiento con guía antivuelco



Freno regulable



Opción tirador	Ref.
Extraplano 22x1,6x0,7 cm	1731
Largo 40x1,2x1,5 cm	1732



Mamparas a medida y cristales especiales	TRANSPARENTE	FROST PLUS / PARSOL CARGLASS / MATE
Altura hasta 197 cm	+45%	+55%

*Plazo de entrega 15 días (más información en pág. 258)

rotary angular al vértice

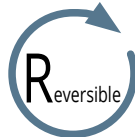
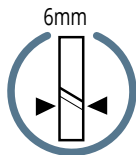
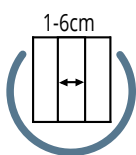

Descripción	TRANSPARENTE	FROST PLUS
	Ref.	Ref.
lado ROTARY 70 1fijo+1corredera	5218	6218
lado ROTARY 75 1fijo+1corredera	5229	6229
lado ROTARY 80 1fijo+1corredera	5219	6219
lado ROTARY 90 1fijo+1corredera	5220	6220
lado ROTARY 100 1fijo+1corredera	5221	6221
lado ROTARY 120 1fijo+1corredera	5222	6222
corner kit unión lado + lado	5223	
corner kit unión frontal + lado	5224	

combinaciones angular **ROTARY** apertura al vértice

Medida	Rangos	Apertura	TRANSPARENTE	FROST PLUS
70x70	65-70 / 65-70	34 - 37	Referencias 5218+5218+5223	Referencias 6218+6218+5223
75x70	70-75 / 65-70	36 - 39	5229+5218+5223	6229+6218+5223
80x70	75-80 / 65-70	38 - 41	5219+5218+5223	6219+6218+5223
90x70	85-90 / 65-70	42 - 45	5220+5218+5223	6220+6218+5223
100x70	95-100 / 65-70	46 - 49	5221+5218+5223	6221+6218+5223
110x70	104-109 / 65-70	47 - 50	5202+5218+5224	6202+6218+5224
120x70	115-120 / 65-70	50 - 53	5222+5218+5223	6222+6218+5223
Medida	Rangos	Apertura	Referencias	Referencias
75x75	70-75 / 70-75	38 - 41	5229+5229+5223	6229+6229+5223
80x75	75-80 / 70-75	40 - 43	5219+5229+5223	6219+6229+5223
90x75	85-90 / 70-75	45 - 48	5220+5229+5223	6220+6229+5223
100x75	95-100 / 70-75	48 - 51	5221+5229+5223	6221+6229+5223
110x75	104-109 / 70-75	49 - 52	5202+5229+5224	6202+6229+5224
120x75	115-120 / 70-75	52 - 55	5222+5229+5223	6222+6229+5223
Medida	Rangos	Apertura	Referencias	Referencias
80x80	75-80 / 75-80	41 - 44	5219+5219+5223	6219+6219+5223
90x80	85-90 / 75-80	45 - 48	5220+5219+5223	6220+6219+5223
100x80	95-100 / 75-80	49 - 52	5221+5219+5223	6221+6219+5223
110x80	104-109 / 75-80	50 - 53	5202+5219+5224	6202+6219+5224
120x80	115-120 / 75-80	53 - 56	5222+5219+5223	6222+6219+5223
Medida	Rangos	Apertura	Referencias	Referencias
90x90	85-90 / 85-90	48 - 51	5220+5220+5223	6220+6220+5223
100x90	95-100 / 85-90	52 - 55	5221+5220+5223	6221+6220+5223
110x90	104-109 / 85-90	53 - 56	5202+5220+5224	6202+6220+5224
120x90	115-120 / 85-90	55 - 58	5222+5220+5223	6222+6220+5223

Referencias	Descripción
5179	perfil de compensación +1,5 cm



Mamparas a medida y cristales especiales	TRANSPARENTE	FROST PLUS / PARSOL CARGLASS / MATE
Altura hasta 197 cm	+45%	+55%

*Plazo de entrega 15 días (más información en pág. 258)

rotary frontal + lateral fijo de 8 mm



Descripción	Rango	TRANSPARENTE	FROST PLUS
		Ref.	Ref.
lateral fijo ROTARY 70	67 - 69	5225	6225
lateral fijo ROTARY 75	72 - 74	5257	6257
lateral fijo ROTARY 80	77 - 79	5226	6226
lateral fijo ROTARY 90	87 - 89	5227	6227



Laterales fijos a medida

Descripción	TRANSPARENTE	FROST PLUS
	Ref.	Ref.
lateral fijo a medida hasta 40 cm	1348	1348+1312
lateral fijo a medida de 40 hasta 80 cm	1332	1332+1313
lateral fijo a medida de 80 hasta 120 cm	1333	1333+1315

*Plazo de entrega 15 días (más información en página 259)

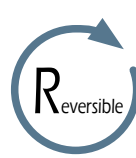
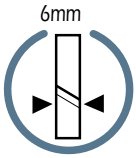
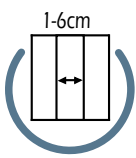
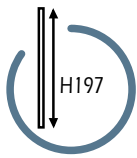

frontales + lateral fijo de 8 mm

		TRANSPARENTE	FROST PLUS
Medidas	Rangos	Referencias	Referencias
100x70	95-100/67-69	5201+5225	6201+6225
110x70	105-110/67-69	5203+5225	6203+6225
120x70	115-120/67-69	5205+5225	6205+6225
130x70	125-130/67-69	5207+5225	6207+6225
140x70	135-140/67-69	5209+5225	6209+6225
150x70	145-150/67-69	5211+5225	6211+6225
160x70	155-160/67-69	5213+5225	6213+6225
170x70	165-170/67-69	5215+5225	6215+6225
180x70	175-180/67-69	5217+5225	6217+6225
Medidas	Rangos	Referencias	Referencias
100x75	95-100/72-74	5201+5257	6201+6257
110x75	105-110/72-74	5203+5257	6203+6257
120x75	115-120/72-74	5205+5257	6205+6257
130x75	125-130/72-74	5207+5257	6207+6257
140x75	135-140/72-74	5209+5257	6209+6257
150x75	145-150/72-74	5211+5257	6211+6257
160x75	155-160/72-74	5213+5257	6213+6257
170x75	165-170/72-74	5215+5257	6215+6257
180x75	175-180/72-74	5217+5257	6217+6257
Medidas	Rangos	Referencias	Referencias
100x80	95-100/77-79	5201+5226	6201+6226
110x80	105-110/77-79	5203+5226	6203+6226
120x80	115-120/77-79	5205+5226	6205+6226
130x80	125-130/77-79	5207+5226	6207+6226
140x80	135-140/77-79	5209+5226	6209+6226
150x80	145-150/77-79	5211+5226	6211+6226
160x80	155-160/77-79	5213+5226	6213+6226
170x80	165-170/77-79	5215+5226	6215+6226
180x80	175-180/77-79	5217+5226	6217+6226
Medidas	Rangos	Referencias	Referencias
100x90	95-100/87-89	5201+5227	6201+6227
110x90	105-110/87-89	5203+5227	6203+6227
120x90	115-120/87-89	5205+5227	6205+6227
130x90	125-130/87-89	5207+5227	6207+6227
140x90	135-140/87-89	5209+5227	6209+6227
150x90	145-150/87-89	5211+5227	6211+6227
160x90	155-160/87-89	5213+5227	6213+6227
170x90	165-170/87-89	5215+5227	6215+6227
180x90	175-180/87-89	5217+5227	6217+6227

*Se pueden hacer otras combinaciones con medidas intermedias de frontales

Referencias	Descripción
5179	perfil de compensación +1,5 cm (sólo válido para frontal)
1075	perfil unión fijo - fijo (más información pág. 260)

futura

INOX

Minimalismo en estado puro.

Mampara de acero inoxidable con cristales de 6 mm.

El modelo Futura está disponible en todas las medidas en formatos frontal, angular al vértice y angular con lateral fijo de 8 mm.

Futura se caracteriza por su elegante barra minimalista y su novedoso sistema de dobles rodamientos ocultos en paralelo.

Este modelo incluye tratamiento anticorrosión de serie.

NOVEDADES Y MEJORAS:

Vierteaguas y gomas 100% silic. transparentes

Laterales fijos de 75 cm

Formatos Spazio simétricos de 160 y 180





ACERO

futura 1 fijo + 1 corredera



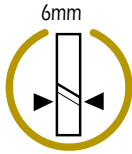
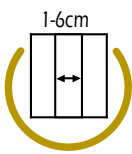

frontales **FUTURA** 1fijo+1corredera

Medida	Apertura	TRANSPARENTE	FROST PLUS
		Ref.	Ref.
95-100	36 - 41	5301	6301
100-105	36 - 41	5302	6302
105-110	41 - 46	5303	6303
110-115	41 - 46	5304	6304
115-120	46 - 51	5305	6305
120-125	46 - 51	5306	6306
125-130	51 - 56	5307	6307
130-135	51 - 56	5308	6308
135-140	56 - 61	5309	6309
140-145	56 - 61	5310	6310
145-150	61 - 66	5311	6311
150-155	61 - 66	5312	6312
155-160	61 - 66	5313	6313
160-165	61 - 66	5314	6314
165-170	66 - 71	5315	6315
170-175	61 - 66	5316	6316
175-180	66 - 71	5317	6317

5179 perfil de compensación para parte fija + 1,5 cm

0008 pletina embellecedora 195x3,8 cm



Perfilería y accesorios en acero inoxidable



Revolucionario sistema de cuatro ruedas por rodamiento



Guiador y vierteaguas en acero

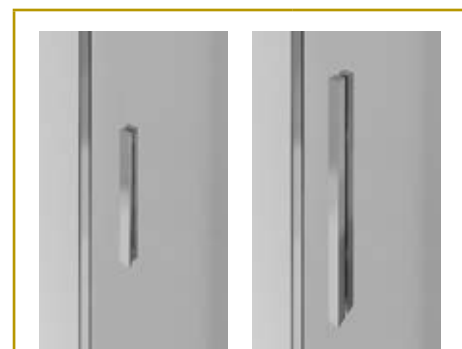

Opción tirador	Ref.
Extraplano 22x1,6x0,7 cm	1731
Largo 40x1,2x1,5 cm	1732



Mamparas a medida y cristales especiales	TRANSPARENTE	FROST PLUS / PARSOL CARGLASS / MATE
Altura hasta 200 cm	+45%	+55%

*Plazo de entrega 15 días

futura spazio 2 fijos + 2 correderas



frontales FUTURA SPAZIO 2 fijos + 2 correderas

Referencias	Descripción	Apertura	Cruce	Rango
5029x2+5351	FUTURA SPAZIO 140 (75+75)	46 - 56	1 - 6	132 - 142
5019x2+5351	FUTURA SPAZIO 150 (80+80)	56 - 66	1 - 6	142 - 152
5030x2+5351	FUTURA SPAZIO 160 (85+85)	64 - 74	1 - 6	152 - 162
5020x2+5351	FUTURA SPAZIO 170 (90+90)	66 - 76	1 - 6	162 - 172
5031x2+5354	FUTURA SPAZIO 180 (95+95)	72 - 82	1 - 6	172 - 182
5021x2+5354	FUTURA SPAZIO 190 (100+100)	76 - 86	1 - 6	182 - 192
5001x2+5354	FUTURA SPAZIO 200 (100+100)	76 - 86	1 - 6	190 - 200
5002x2+5354	FUTURA SPAZIO 210 (105+105)	76 - 86	1 - 6	200 - 210

Referencias	Descripción
5179	perfil de compensación +1,5 cm



futura spazio frost plus 2 fijos + 2 correderas

ACERO



frontales FUTURA SPAZIO FROST PLUS 2 fijos + 2 correderas

Referencias	Descripción	Apertura	Cruce	Rango
6029x2+5351	FUTURA SPAZIO FROST PLUS 140 (75+75)	46 - 56	1 - 6	132 - 142
6019x2+5351	FUTURA SPAZIO FROST PLUS 150 (80+80)	56 - 66	1 - 6	142 - 152
6030x2+5351	FUTURA SPAZIO FROST PLUS 160 (85+85)	64 - 74	1 - 6	152 - 162
6020x2+5351	FUTURA SPAZIO FROST PLUS 170 (90+90)	66 - 76	1 - 6	162 - 172
6031x2+5354	FUTURA SPAZIO FROST PLUS 180 (95+95)	72 - 82	1 - 6	172 - 182
6021x2+5354	FUTURA SPAZIO FROST PLUS 190 (100+100)	76 - 86	1 - 6	182 - 192
6001x2+5354	FUTURA SPAZIO FROST PLUS 200 (100+100)	76 - 86	1 - 6	190 - 200
6002x2+5354	FUTURA SPAZIO FROST PLUS 210 (105+105)	76 - 86	1 - 6	200 - 210

Referencias	Descripción
5179	perfil de compensación +1,5 cm



futura angular al vértice



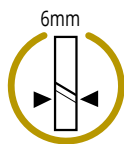
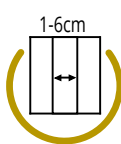
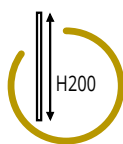

			TRANSPARENTE	FROST PLUS
Medidas	Rangos	Apertura	Referencias	Referencias
70x70	65-70 / 65-70	34 - 37	5018+5018+5323	6018+6018+5323
75x70	70-75 / 65-70	36 - 39	5029+5018+5323	6029+6018+5323
80x70	75-80 / 65-70	38 - 41	5019+5018+5323	6019+6018+5323
90x70	85-90 / 65-70	43 - 45	5020+5018+5323	6020+6018+5323
100x70	95-100 / 65-70	46 - 49	5021+5018+5323	6021+6018+5323
110x70	104-109 / 65-70	47 - 50	5002+5018+5323	6002+6018+5323
120x70	115-120 / 65-70	50 - 53	5022+5018+5323	6022+6018+5323
Medidas	Rangos	Apertura	Referencias	Referencias
75x75	70-75 / 70-75	38 - 41	5029+5029+5323	6029+6029+5323
80x75	75-80 / 70-75	40 - 43	5019+5029+5323	6019+6029+5323
90x75	85-90 / 70-75	45 - 48	5020+5029+5323	6020+6029+5323
100x75	95-100 / 70-75	48 - 51	5021+5029+5323	6021+6029+5323
110x75	104-109 / 70-75	49 - 52	5002+5029+5323	6002+6029+5323
120x75	115-120 / 70-75	52 - 55	5022+5029+5323	6022+6029+5323
Medidas	Rangos	Apertura	Referencias	Referencias
80x80	75-80 / 75-80	41 - 44	5019+5019+5323	6019+6019+5323
90x80	85-90 / 75-80	45 - 48	5020+5019+5323	6020+6019+5323
100x80	95-100 / 75-80	49 - 52	5021+5019+5323	6021+6019+5323
110x80	104-109 / 75-80	50 - 53	5002+5019+5323	6002+6019+5323
120x80	115-120 / 75-80	53 - 56	5022+5019+5323	6022+6019+5323
Medidas	Rangos	Apertura	Referencias	Referencias
90X90	85-90 / 85-90	48 - 51	5020+5020+5323	6020+6020+5323
100X90	95-100 / 85-90	52 - 55	5021+5020+5323	6021+6020+5323
110x90	104-109 / 85-90	53 - 56	5002+5020+5323	6002+6020+5323
120X90	115-120 / 85-90	55 - 58	5022+5020+5323	6022+6020+5323

Referencias	Descripción
5179	perfil de compensación +1,5 cm



Perfilería y accesorios en acero inoxidable



Revolucionario sistema de cuatro ruedas por rodamiento



Guiador y vierteaguas en acero



Tirador metálico



Mamparas a medida y cristales especiales	TRANSPARENTE	FROST PLUS / PARSOL CARGLASS / MATE
Altura hasta 200 cm	+45%	+55%

*Plazo de entrega 15 días (más información en pág. 258)

futura frontal + lateral fijo de 8 mm



Descripción	Rango	TRANSPARENTE	FROST PLUS
		Ref.	Ref.
lateral fijo FUTURA 70	67 - 69	5325	6325
lateral fijo FUTURA 75	72 - 74	5357	6357
lateral fijo FUTURA 80	77 - 79	5326	6326
lateral fijo FUTURA 90	87 - 89	5327	6327



Laterales fijos a medida

Descripción	TRANSPARENTE	FROST PLUS
	Ref.	Ref.
lateral fijo a medida hasta 40 cm	1347	1347+1312
lateral fijo a medida de 40 hasta 80 cm	1330	1330+1313
lateral fijo a medida de 80 hasta 120 cm	1331	1331+1315

*Plazo de entrega 15 días (más información en página 259)

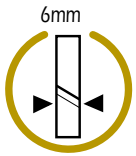
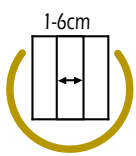
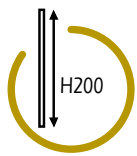

frontales + lateral fijo de 8 mm

		TRANSPARENTE	FROST PLUS
Medidas	Rangos	Referencias	Referencias
100x70	95-100/67-69	5301+5325	6301+6325
110x70	105-110/67-69	5303+5325	6303+6325
120x70	115-120/67-69	5305+5325	6305+6325
130x70	125-130/67-69	5307+5325	6307+6325
140x70	135-140/67-69	5309+5325	6309+6325
150x70	145-150/67-69	5311+5325	6311+6325
160x70	155-160/67-69	5313+5325	6313+6325
170x70	165-170/67-69	5315+5325	6315+6325
180x70	175-180/67-69	5317+5325	6317+6325
Medidas	Rangos	Referencias	Referencias
100x75	95-100/72-74	5301+5357	6301+6357
110x75	105-110/72-74	5303+5357	6303+6357
120x75	115-120/72-74	5305+5357	6305+6357
130x75	125-130/72-74	5307+5357	6307+6357
140x75	135-140/72-74	5309+5357	6309+6357
150x75	145-150/72-74	5311+5357	6311+6357
160x75	155-160/72-74	5313+5357	6313+6357
170x75	165-170/72-74	5315+5357	6315+6357
180x75	175-180/72-74	5317+5357	6317+6357
Medidas	Rangos	Referencias	Referencias
100x80	95-100/77-79	5301+5326	6301+6326
110x80	105-110/77-79	5303+5326	6303+6326
120x80	115-120/77-79	5305+5326	6305+6326
130x80	125-130/77-79	5307+5326	6307+6326
140x80	135-140/77-79	5309+5326	6309+6326
150x80	145-150/77-79	5311+5326	6311+6326
160x80	155-160/77-79	5313+5326	6313+6326
170x80	165-170/77-79	5315+5326	6315+6326
180x80	175-180/77-79	5317+5326	6317+6326
Medidas	Rangos	Referencias	Referencias
100x90	95-100/87-89	5301+5327	6301+6327
110x90	105-110/87-89	5303+5327	6303+6327
120x90	115-120/87-89	5305+5327	6305+6327
130x90	125-130/87-89	5307+5327	6307+6327
140x90	135-140/87-89	5309+5327	6309+6327
150x90	145-150/87-89	5311+5327	6311+6327
160x90	155-160/87-89	5313+5327	6313+6327
170x90	165-170/87-89	5315+5327	6315+6327
180x90	175-180/87-89	5317+5327	6317+6327

*Se pueden hacer otras combinaciones con medidas intermedias de frontales

Referencias	Descripción
5179	perfil de compensación +1,5 cm (sólo válido para frontal)

moving

INOX

Todo un clásico en Acero

Mampara de acero inoxidable con cristales de 8 mm.
El modelo Moving está disponible en todas las medidas
y formatos.

El modelo Moving destaca por su barra circular de acero
inoxidable sobre las que se deslizan los rodamientos.

NOVEDADES:

Tratamiento anticorrosión de serie





ACERO

moving 1 fijo + 1 corredera



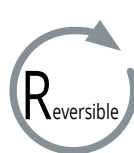
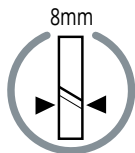
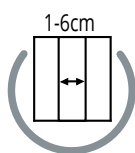

**incluye
tratamiento
antical**

frontales MOVING 1fijo+1corredera

Referencias	Descripción	Apertura	Rango
1003	frontal ducha MOVING 100	40-45	97 - 102
1103	frontal ducha MOVING 105	40-45	102 - 107
1004	frontal ducha MOVING 110	45-50	107 - 112
1104	frontal ducha MOVING 115	42-47	112 - 117
1005	frontal ducha MOVING 120	47-52	117 - 122
1105	frontal ducha MOVING 125	52-57	122 - 127
1006	frontal ducha MOVING 130	47-52	127 - 132
1106	frontal ducha MOVING 135	52-57	132 - 137
1007	frontal ducha MOVING 140	57-62	137 - 142
1107	frontal ducha MOVING 145	52-57	142 - 147
1008	frontal ducha MOVING 150	57-62	147 - 152
1108	frontal ducha MOVING 155	57-62	152 - 157
1009	frontal ducha MOVING 160	62-67	157 - 162
1109	frontal ducha MOVING 165	67-72	162 - 167
1010	frontal ducha MOVING 170	62-67	167 - 172
1110	frontal ducha MOVING 175	67-72	172 - 177
1011	frontal ducha MOVING 180	67-72	177 - 182
1074	perfil expansión +1 cm		
1072	Opción cierre perfil + junta burbuja *Con este sistema el rango se reduce 2 cm		



guía y vierteaguas acero



barra y herrajes acero



tirador metálico



perfilería acero

moving spazio 2fijos + 2correderas



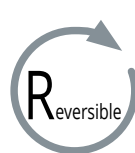
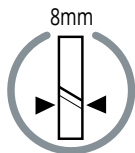
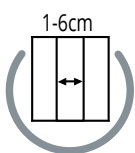

frontales MOVING 2fijos+2correderas

Referencias	Descripción	Apertura	Rango
1012	frontal ducha MOVING STEEL SPAZIO 160	51 - 61	152 - 162
1013	frontal ducha MOVING STEEL SPAZIO 170	61 - 71	162 - 172
1014	frontal ducha MOVING STEEL SPAZIO 180	61 - 71	172 - 182
1074	perfil de compensación +1 cm		



perfilería acero



barra y herrajes acero



tirador metálico



guía y vierteaguas acero

moving angular al vértice



Referencias	Descripción
1000	lado MOVING 70 1fijo+1corredera
1001	lado MOVING 80 1fijo+1corredera
1002	lado MOVING 90 1fijo+1corredera
1102	lado MOVING100 1fijo+1corredera

Referencias	Descripción
1017	Kit conversión en angular

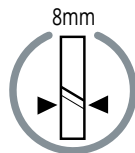
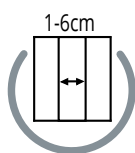

incluye
tratamiento
antical

combinaciones MOVING apertura al vértice

Medidas	Referencias	Apertura	Rangos
70x70	1000+1000+1017	34 - 36	66-70/66-70
80x70	1001+1000+1017	38 - 40	76-80/66-70
90x70	1002+1000+1017	42 - 44	86-90/66-70
100x70	1102+1000+1017	45 - 47	96-100/66-70
110x70	1103+1000+1017	47 - 49	104-109/66-70
120x70	1104+1000+1017	49 - 51	116-122/66-70
130x70	1105+1000+1017	57 - 59	124-129/66-70
140x70	1106+1000+1017	57 - 59	134-139/66-70
Medidas	Referencias	Apertura	Rangos
80x80	1001+1001+1017	41 - 43	76-80/76-80
90x80	1002+1001+1017	45 - 47	86-90/76-80
100x80	1102+1001+1017	48 - 50	96-100/76-80
110x80	1103+1001+1017	50 - 52	104-109/76-80
120x80	1104+1001+1017	52 - 54	116-122/76-80
130x80	1105+1001+1017	60 - 62	124-129/76-80
140x80	1106+1001+1017	60 - 62	134-139/76-80
Medidas	Referencias	Apertura	Rangos
90x90	1002+1002+1017	48 - 50	86-90/86-90
100x90	1102+1002+1017	51 - 53	96-100/86-90
110x90	1103+1002+1017	53 - 55	104-109/86-90
120x90	1104+1002+1017	55 - 57	116-122/86-90
130x90	1105+1002+1017	63 - 65	124-129/86-90
140x90	1106+1002+1017	63 - 65	134-139/86-90
1074	Perfil de compensación +1 cm		

*También se pueden combinar los frontales con medidas intermedias.

*El rango aumenta 2 cm con respecto al formato frontal.



moving frontal + lateral fijo



Referencias	Descripción	Rango
1015	lateral MOVING 70 fijo	67 - 69
1100	lateral MOVING 75 fijo	72 - 74
1016	lateral MOVING 80 fijo	77 - 79
1018	lateral MOVING 90 fijo	87 - 89

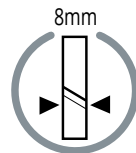
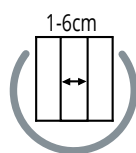

**incluye
tratamiento
antical**

combinaciones frontales **MOVING** + lateral fijo 8 mm

Medidas	Referencias	Rangos	Medidas	Referencias	Rangos
100X70	1003+1015	96-100/67-69	100X75	1003+1100	96-100/72-74
110X70	1004+1015	106-110/67-69	110X75	1004+1100	106-110/ 72-74
120X70	1005+1015	116-120/67-69	120X75	1005+1100	116-120/ 72-74
130X70	1006+1015	126-130/67-69	130X75	1006+1100	126-130/ 72-74
140X70	1007+1015	136-140/67-69	140X75	1007+1100	136-140/ 72-74
150X70	1008+1015	146-150/67-69	150X75	1008+1100	146-150/ 72-74
160X70	1009+1015	156-160/67-69	160X75	1009+1100	156-160/ 72-74
170X70	1010+1015	166-170/67-69	170X75	1010+1100	166-170/ 72-74
180X70	1011+1015	176-180/67-69	180X75	1011+1100	176-180/ 72-74
Medidas	Referencias	Rangos	Medidas	Referencias	Rangos
100X80	1003+1016	96-100/77-79	100X90	1003+1018	96-100/87-89
110X80	1004+1016	106-110/77-79	110X90	1004+1018	106-110/87-89
120X80	1005+1016	116-120/77-79	120X90	1005+1018	116-120/87-89
130X80	1006+1016	126-130/77-79	130X90	1006+1018	126-130/87-89
140X80	1007+1016	136-140/77-79	140X90	1007+1018	136-140/87-89
150X80	1008+1016	146-150/77-79	150X90	1008+1018	146-150/87-89
160X80	1009+1016	156-160/77-79	160X90	1009+1018	156-160/87-89
170X80	1010+1016	166-170/77-79	170X90	1010+1018	166-170/87-89
180X80	1011+1016	176-180/77-79	180X90	1011+1018	176-180/87-89

1074 perfil pared (+1cm)

*Se pueden combinar los frontales con medidas intermedias.

*El rango se reduce 2 cm con respecto al formato frontal.

*La apertura es la misma que en los frontales.



Laterales fijos a medida (más información en página 259)

Referencias	Descripción
1341	lateral fijo a medida MOVING hasta 40 cm
1301	lateral fijo a medida MOVING de 40 hasta 80 cm
1307	lateral fijo a medida MOVING de 80 hasta 120 cm
1075	perfil de unión fijo + lateral fijo (ver pág. 260)

65

*Plazo de entrega 15 días

TRIO pg. 124
1 fijo y 2 correderas

TANDEM pg. 126
Plegable + fijo y corredera

PUERTAS PASO pg. 128



GIRO 360° pg.130
Puerta giratoria

BYPASS pg.134
2 correderas

AKORD pg.136
Plegable

+SOLUCIONES



**OTRAS
SOLUCIONES**

trio 1 fijo + 2correderas



Referencias	Descripción	Apertura	Rango
1230	frontal 1fijo+2correderas TRIO 90	43-45	86-91
1231	frontal 1fijo+2correderas TRIO 95	46-48	91-96
1232	frontal 1fijo+2correderas TRIO 100	49-51	96-101
1233	frontal 1fijo+2correderas TRIO 105	53-55	101-106
1234	frontal 1fijo+2correderas TRIO 110	56-58	106-111
1235	frontal 1fijo+2correderas TRIO 115	59-61	111-116
1236	frontal 1fijo+2correderas TRIO 120	63-65	116-121
1237	frontal 1fijo+2correderas TRIO 125	66-68	121-126
1238	frontal 1fijo+2correderas TRIO 130	69-71	126-131
1239	frontal 1fijo+2correderas TRIO 135	73-75	131-136
1240	frontal 1fijo+2correderas TRIO 140	76-78	136-141
1243	frontal 1fijo+2correderas TRIO 145	79-81	141-146
1244	frontal 1fijo+2correderas TRIO 150	82-84	146-151
1245	frontal 1fijo+2correderas TRIO 155	85-88	151-156
1246	frontal 1fijo+2correderas TRIO 160	89-91	156-161
0007	embellecedor trio		

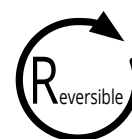
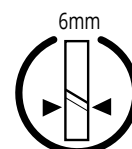
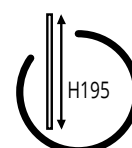

trio frontal + lateral fijo



laterales fijos TRIO

Referencias	Descripción	Rango
1241	lateral fijo TRIO 70	67-69,5
1242	lateral fijo TRIO 80	77-79,5
0218	perfil compensación lateral fijo +3 cm	
0029	perfil compensación lateral fijo +6 cm	

*Perfiles de compensación sólo para laterales fijos.

combinaciones frontales TRIO + lateral fijo

Medidas	Referencias	Rangos	Medidas	Referencias	Rangos
90x70	1230 + 1241	87-89,5 / 67-69,5	90x80	1230 + 1242	87-89,5 / 77-79,5
95x70	1231 + 1241	92-94,5 / 67-69,5	95x80	1231 + 1242	92-94,5 / 77-79,5
100x70	1232 + 1241	97-99,5 / 67-69,5	100x80	1232 + 1242	97-99,5 / 77-79,5
105x70	1233 + 1241	102-104,5 / 67-69,5	105x80	1233 + 1242	102-104,5 / 77-79,5
110x70	1234 + 1241	107-109,5 / 67-69,5	110x80	1234 + 1242	107-109,5 / 77-79,5
115x70	1235 + 1241	112-114,5 / 67-69,5	115x80	1235 + 1242	112-114,5 / 77-79,5
120x70	1236 + 1241	117-119,5 / 67-69,5	120x80	1236 + 1242	117-119,5 / 77-79,5
125x70	1237 + 1241	122-124,5 / 67-69,5	125x80	1237 + 1242	122-124,5 / 77-79,5
130x70	1238 + 1241	127-129,5 / 67-69,5	130x80	1238 + 1242	127-129,5 / 77-79,5
135x70	1239 + 1241	132-134,5 / 67-69,5	135x80	1239 + 1242	132-134,5 / 77-79,5
140x70	1240 + 1241	137-139,5 / 67-69,5	140x80	1240 + 1242	137-139,5 / 77-79,5
145x70	1243 + 1241	142-144,5 / 67-69,5	145x80	1243 + 1242	142-144,5 / 77-79,5
150x70	1244 + 1241	147-149,5 / 67-69,5	150x80	1244 + 1242	147-149,5 / 77-79,5
155x70	1245 + 1241	152-154,5 / 67-69,5	155x80	1245 + 1242	152-154,5 / 77-79,5
160x70	1246 + 1241	157-159,5 / 67-69,5	160x80	1246 + 1242	157-159,5 / 77-79,5



Laterales fijos a Medida TRIO (más información en página 259)

Referencias	Descripción
1342	lateral fijo a medida hasta 40 cm
1303	lateral fijo a medida desde 40 hasta 80 cm
1309	lateral fijo a medida desde 80 hasta 120 cm

*Plazo de entrega 15 días

tandem fijo + corredera + plegable



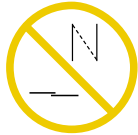
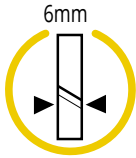
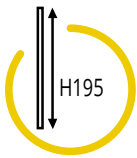

combinaciones TANDEM angular

F+C x Pleg.	Apert.	Referencias	Rangos	F+C x Pleg.	Apert.	Referencias	Rangos
70x70	59	5018+5423+1740	63-68 / 66,5-69,5	70x75	66	5018+5423+1743	63-68 / 71,5-74,5
75x70	59	5029+5423+1740	68-73 / 66,5-69,5	75x75	67	5029+5423+1743	68-73 / 71,5-74,5
80x70	61	5019+5423+1740	73-78 / 66,5-69,5	80x75	68	5019+5423+1743	73-78 / 71,5-74,5
85x70	63	5030+5423+1740	78-83 / 66,5-69,5	85x75	69	5030+5423+1743	78-83 / 71,5-74,5
90x70	64	5020+5423+1740	83-88 / 66,5-69,5	90x75	70	5020+5423+1743	83-88 / 71,5-74,5
95x70	66	5031+5423+1740	88-93 / 66,5-69,5	95x75	72	5031+5423+1743	88-93 / 71,5-74,5
100x70	67	5021+5423+1740	93-98 / 66,5-69,5	100x75	73	5021+5423+1743	93-98 / 71,5-74,5
110x70	68	5002+5423+1740	102-107 / 66,5-69,5	110x75	74	5002+5423+1743	102-107 / 71,5-74,5
120x70	73	5022+5423+1740	113-118 / 66,5-69,5	120x75	79	5022+5423+1743	113-118 / 71,5-74,5
130x70	74	5006+5424+1740	122-127 / 66,5-69,5	130x75	80	5006+5424+1743	122-127 / 71,5-74,5
140x70	78	5008+5424+1740	132-137 / 66,5-69,5	140x75	83	5008+5424+1743	132-137 / 71,5-74,5
F+C x Pleg.	Apert.	Referencias	Rangos	F+C x Pleg.	Apert.	Referencias	Rangos
70x80	68	5018+5423+1741	63-68 / 76,5-79,5	70x90	77	5018+5423+1742	63-68 / 86,5-89,5
75x80	68	5029+5423+1741	68-73 / 76,5-79,5	75x90	77	5029+5423+1742	68-73 / 86,5-89,5
80x80	70	5019+5423+1741	73-78 / 76,5-79,5	80x90	79	5019+5423+1742	73-78 / 86,5-89,5
85x80	71	5030+5423+1741	78-83 / 76,5-79,5	85x90	80	5030+5423+1742	78-83 / 86,5-89,5
90x80	72	5020+5423+1741	83-88 / 76,5-79,5	90x90	81	5020+5423+1742	83-88 / 86,5-89,5
95x80	74	5031+5423+1741	88-93 / 76,5-79,5	95x90	82	5031+5423+1742	88-93 / 86,5-89,5
100x80	75	5021+5423+1741	93-98 / 76,5-79,5	100x90	83	5021+5423+1742	93-98 / 86,5-89,5
110x80	76	5002+5423+1741	102-107 / 76,5-79,5	110x90	84	5002+5423+1742	102-107 / 86,5-89,5
120x80	81	5022+5423+1741	113-118 / 76,5-79,5	120x90	88	5022+5423+1742	113-118 / 86,5-89,5
130x80	82	5006+5424+1741	122-127 / 76,5-79,5	130x90	89	5006+5424+1742	122-127 / 86,5-89,5
140x80	85	5008+5424+1741	132-137 / 76,5-79,5	140x90	92	5008+5424+1742	132-137 / 86,5-89,5

Se pueden combinar con frontales Basic de medidas intermedias, rango +2 cm.

Referencias	Descripción
5429	perfil compensación +1,5 cm para lado fijo + corredera
1222	perfil compensación +2,5 para lado plegable



Mamparas a medida y cristales especiales

- Mamparas a medida +45%

Se puede fabricar a medida el lado de fijo y corredera y la puerta del lado plegable con altura 195 cm.

*Plazo de entrega 15 días

PUERTAS DE PASO CROMO

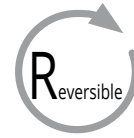
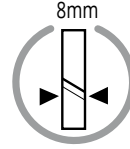
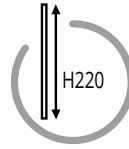

NOVEDAD



Descripción	Ref.
Puerta de 75 cm + kit barra/guía 150 cm cromo	1750+1752
Puerta de 85 cm + kit barra/guía 170 cm cromo	1751+1753

PUERTAS DE PASO NEGRO

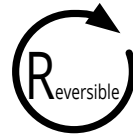
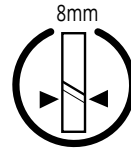
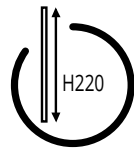

NOVEDAD



+SOLUCIONES

Descripción	Ref.
Puerta de 75 cm + kit barra/guía 150 cm negro	1750+1754
Puerta de 85 cm + kit barra/guía 170 cm negro	1751+1755

giro 360° 1 puerta giratoria



COMBI A Frontal GIRO 360° 1 puerta

Medida	Referencias	Apertura	Rango
100	1212+1250+1212+1253	46	102,6/107,6
105	1212+1251+1212+1253	48	107,6/112,6
110	1212+1252+1212+1253	51	112,6/117,6

*Permite unión con laterales fijos STD en ambos lados rango mínimo +0,7 cm (ver pág. 60). Necesario kit accesorios ref. 1256

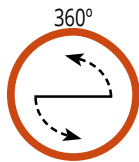
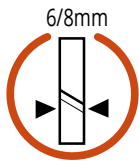
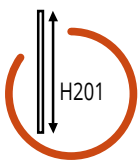

+SOLUCIONES

COMBI B Frontal GIRO 360° 1 fijo + 1 puerta

Medidas	Fijo	Puerta	Apertura	Referencias	Rango
120	20	100	46	1200+1250+1212+1254	117,5/122,5
125	25	100	46	1201+1250+1212+1254	122,5/127,5
125	20	105	48	1200+1251+1212+1254	122,5/127,5
130	30	100	46	1202+1250+1212+1254	127,5/132,5
130	25	105	48	1201+1251+1212+1254	127,5/132,5
130	20	110	51	1200+1252+1212+1254	127,5/132,5
135	30	105	48	1202+1251+1212+1254	132,5/137,5
135	25	110	51	1201+1252+1212+1254	132,5/137,5
140	40	100	46	1203+1250+1212+1254	137,5/142,5
140	30	110	51	1202+1252+1212+1254	137,5/142,5
145	40	105	48	1203+1251+1212+1254	142,5/147,5
150	50	100	46	1204+1250+1212+1254	147,5/152,5
150	40	105	48	1203+1252+1212+1254	147,5/152,5
155	50	100	46	1204+1251+1212+1254	152,5/157,5
160	60	100	46	1205+1250+1212+1254	157,5/162,5
160	50	110	51	1204+1252+1212+1254	157,5/162,5
165	60	105	48	1205+1251+1212+1254	162,5/167,5
170	60	110	51	1205+1252+1212+1254	167,5/172,5

*Permite unión con laterales fijos STD en ambos lados rango mínimo +0,7 cm (ver pág. 60). Necesario kit accesorios ref. 1256

giro 360° fijo + puerta + fijo



COMBI C Frontal GIRO 360° fijo + puerta + fijo

Medidas	Apertura	Referencias	Rango
135 (20+100+20)	46	1200+1250+1200+1255	132,6/137,6
140 (20+100+25)	46	1200+1250+1201+1255	137,6/142,6
140 (20+105+20)	48	1200+1251+1200+1255	137,6/142,6
145 (20+100+30)	46	1200+1250+1202+1255	142,6/147,6
145 (20+105+25)	48	1200+1251+1201+1255	142,6/147,6
145 (20+110+20)	51	1200+1252+1200+1255	142,6/147,6
145 (25+100+25)	46	1201+1250+1201+1255	142,6/147,6
150 (20+105+30)	48	1200+1251+1202+1255	147,6/152,6
150 (20+110+25)	51	1200+1252+1201+1255	147,6/152,6
150 (25+100+30)	46	1201+1250+1202+1255	147,6/152,6
150 (25+105+25)	48	1201+1251+1201+1255	147,6/152,6
155 (20+100+40)	46	1200+1250+1203+1255	152,6/157,6
155 (20+110+30)	51	1200+1252+1202+1255	152,6/157,6
155 (25+105+30)	48	1201+1251+1202+1255	152,6/157,6
155 (30+100+30)	46	1202+1250+1202+1255	152,6/157,6

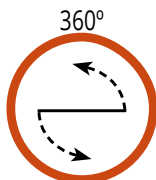
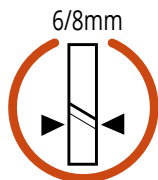
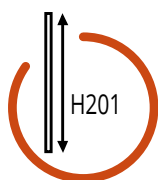

COMBI C Frontal GIRO 360° fijo + puerta + fijo

Medidas	Apertura	Referencias	Rango
160 (20+105+40)	48	1200+1251+1203+1255	157,6/162,6
160 (25+100+40)	46	1201+1250+1203+1255	157,6/162,6
160 (30+105+30)	48	1202+1251+1202+1255	157,6/162,6
165 (20+100+50)	46	1200+1250+1204+1255	162,6/167,6
165 (20+110+40)	51	1200+1252+1203+1255	162,6/167,6
165 (25+105+40)	48	1201+1251+1203+1255	162,6/167,6
165 (30+100+40)	46	1202+1250+1203+1255	162,6/167,6
165 (30+110+30)	51	1202+1252+1202+1255	162,6/167,6
170 (20+105+50)	48	1200+1251+1204+1255	167,6/172,6
170 (25+100+50)	46	1201+1250+1204+1255	167,6/172,6
170 (30+105+40)	48	1202+1251+1203+1255	167,6/172,6
175 (20+100+60)	46	1200+1250+1205+1255	172,6/177,6
175 (20+110+50)	51	1200+1252+1204+1255	172,6/177,6
175 (25+105+50)	48	1201+1251+1204+1255	172,6/177,6
175 (30+100+50)	46	1202+1250+1204+1255	172,6/177,6
175 (30+110+40)	51	1202+1252+1203+1255	172,6/177,6
175 (40+100+40)	46	1203+1250+1203+1255	172,6/177,6
180 (20+105+60)	48	1200+1251+1205+1255	177,6/182,6
180 (25+100+60)	46	1201+1250+1205+1255	177,6/182,6
180 (30+105+50)	48	1202+1251+1204+1255	177,6/182,6
180 (40+105+40)	48	1203+1251+1203+1255	177,6/182,6
185 (20+110+60)	51	1200+1252+1205+1255	182,6/187,6
185 (25+105+60)	48	1201+1251+1205+1255	182,6/187,6
185 (30+100+60)	46	1202+1250+1205+1255	182,6/187,6
185 (30+110+50)	51	1202+1252+1204+1255	182,6/187,6
185 (40+100+50)	46	1203+1250+1204+1255	182,6/187,6
185 (40+110+40)	51	1203+1252+1203+1255	182,6/187,6
190 (30+105+60)	48	1202+1251+1205+1255	187,6/192,6
190 (40+105+50)	48	1203+1251+1204+1255	187,6/192,6
195 (30+110+60)	51	1202+1252+1204+1255	192,6/197,6
195 (40+100+60)	46	1203+1250+1205+1255	192,6/197,6
195 (40+110+50)	51	1203+1252+1205+1255	192,6/197,6
195 (50+100+50)	46	1204+1250+1204+1255	192,6/197,6
200 (50+105+50)	48	1204+1251+1204+1255	197,6/200
200 (40+105+60)	48	1203+1251+1205+1255	197,6/200

*Permite unión con laterales fijos STD en ambos lados rango mínimo +0,7 cm (ver pág. 60). Necesario kit accesorios ref. 1256

bypass 2 correderas



Referencias	Descripción	Apertura	Rango
1270	frontal BYPASS 120	45-55	108 -118
1271	frontal BYPASS 130	50-60	118- 128
1272	frontal BYPASS 140	55-65	128 -138
1273	frontal BYPASS 150	60-70	138 -148
1274	frontal BYPASS 160	65-75	148 -158



Rodamiento oculto 4 poleas

bypass frontal + lateral fijo

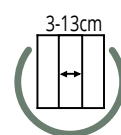
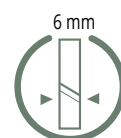

+SOLUCIONES

laterales fijos BYPASS

Ref.	Descripción	Rango
1275	lateral fijo BYPASS 70	66-69
1276	lateral fijo BYPASS 80	76-79

combinaciones frontales BYPASS + lateral fijo

Medidas	Referencias	Rangos	Medidas	Referencias	Rangos
120x70	1270 + 1275	110-120/66-69	120x80	1270 + 1276	110-120/76-79
130x70	1271 + 1275	120-130/66-69	130x80	1271 + 1276	120-130/76-79
140x70	1272 + 1275	130-140/66-69	140x80	1272 + 1276	130-140/76-79
150x70	1273 + 1275	140-150/66-69	150x80	1273 + 1276	140-150/76-79
160x70	1274 + 1275	150-160/66-69	160x80	1274 + 1276	150-160/76-79

*Las aperturas son las mismas que en los frontales.



Laterales fijos a medida (más información en página 259)

Referencias	Descripción
1346	lateral fijo a medida BYPASS hasta 40 cm
1318	lateral fijo a medida BYPASS desde 40 hasta 80 cm
1319	lateral fijo a medida BYPASS desde 80 hasta 120 cm

*Plazo de entrega 15 días



frontales **AKORD**

Referencias	Descripción	Apertura	Rango
0830	frontal AKORD 70 plegable	50	66-71
0831	frontal AKORD 80 plegable	60	76-81
0832	frontal AKORD 90 plegable	70	86-91
0833	frontal AKORD 100 plegable	80	96-101

Referencias	Descripción
0218	perfil compensación +2 cm
0029	perfil compensación +4 cm

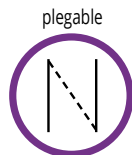
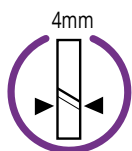
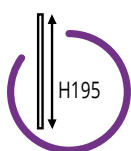

sistema de hojas plegables



tirador interno

combinaciones frontales **AKORD** + lateral fijo STD

Medidas	Referencias	Rangos
70X70	0830+0814	66,4-68,9/66-69
80X70	0831+0814	76,4-78,9/66-69
90X70	0832+0814	86,4-88,9/66-69
100X70	0833+0814	96,4-98,9/66-69

Medidas	Referencias	Rangos
70X75	0830+0820	66,4-68,9/71-74
80X75	0831+0820	76,4-78,9/71-74
90X75	0832+0820	86,4-88,9/71-74
100X75	0833+0820	96,4-98,9/71-74

Medidas	Referencias	Rangos
70X80	0830+0815	66,4-68,9/76-79
80X80	0831+0815	76,4-78,9/76-79
90X80	0832+0815	86,4-88,9/76-79
100X80	0833+0815	96,4-98,9/76-79

Medidas	Referencias	Rangos
70X90	0830+0816	66,4-68,9/86-89
80X90	0831+0816	76,4-78,9/86-89
90X90	0832+0816	86,4-88,9/86-89
100X90	0833+0816	96,4-98,9/86-89

*Se puede combinar con resto de medidas fijos STD (ver pág. 60)

Referencias	Descripción
0218	perfil compensación +2 cm
0029	perfil compensación +4 cm



Laterales fijos a medida (más información en página 259)

Referencias	Descripción
1343	lateral fijo a medida hasta 40 cm
1304	lateral fijo a medida desde 40 hasta 80 cm
1310	lateral fijo a medida desde 80 hasta 120 cm

*Plazo de entrega 15 días

screen

El diseño no tiene que ser complicado

Programa de cristales fijos de 8mm con perfilera minimalista de aluminio y brazos extensibles de acero inoxidable. Screen está disponibles en las medidas de 68, 78, 88, 98, 108 Y 118 cm en cristal transparente y frost plus.

Screen permite la elaboración de mamparas sencillas y prácticas con un solo fijo o combinaciones más elaboradas tipo walk-in.

Screen se puede combinar con hojas abatibles de 25 o 40 cm, con abatible bisagrada de 35 o cristales fijos de 20.

Los brazos en acero inoxidable de la serie permiten su colocación a pared tanto en recto como en diagonal para salvar ventanas.

NOVEDAD:

Opción a medida altura hasta 220 cm

Screen Black pag. 244

Screen White pag. 246





combinación con referencias 0160+0166



	TRANSPARENTE	FROST PLUS
Descripción	Ref.	Ref.
crystal fijo 68	0164	0174
crystal fijo 78	0165	0175
crystal fijo 88	0160	0170
crystal fijo 98	0161	0171
crystal fijo 108	0162	0172
crystal fijo 118	0169	0179

Ref.	Descripción
0166	brazo soporte PARED recto ext. (55-100)
0168	brazo soporte PARED 45° ext. (55-85)
0167	brazo soporte CRISTAL-CRISTAL ext. (55-85)
0184	brazo cuadrado PARED recto/45° ajustable (60-120)

*Otras opciones de brazo (ver página 144).

brazo 0166



brazo 0168



brazo 0167



brazo 0184



screen moving



combinación con referencias 0170+0194+0166



	TRANSPARENTE	FROST PLUS
Descripción	Ref.	Ref.
móvil 25 cm	0153	0193
móvil 40 cm	0154	0194

*Los cristales móviles aumentan 24,5 / 39,5 cm la medida del fijo

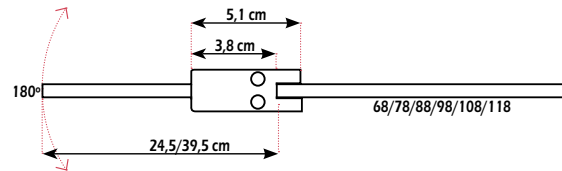

screen 35 bisagra 180°

combinación con referencias 0160+0331+0166



bisagra latón cromado

	TRANSPARENTE	FROST PLUS
Descripción	Ref.	Ref.
móvil de 35 cm	0331	0332

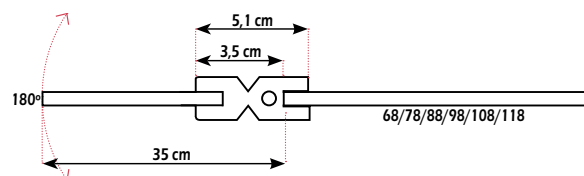

Screen XXL

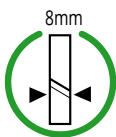
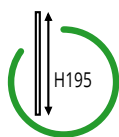

combinación con referencias 0174+0174+0180+0166+0166



Utiliza el perfil unión ref. 0180 para unir cualquiera de las referencias de fijos Screen y conseguir medidas superiores a 118 cm.

Referencia	Descripción
0180	perfil unión para 2 cristales fijos

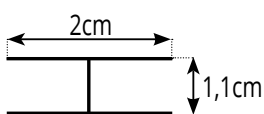

rodapie aluminio

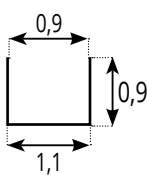

Descripción	Ref.
Opción rodapie aluminio 2 m	0994

perfil angular

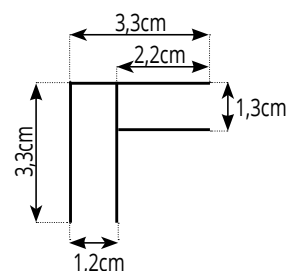

Referencia	Descripción
0182	Perfil en ángulo

*Aumenta 1,3 cm en uno de los lados

Screen towel

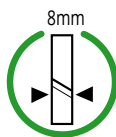
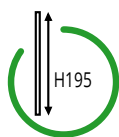

FIJOS

Descripción	Rango	Referencia
Screen 140 c/toallero (incluye brazo 0184)	137-139,5	0995

Screen especiales y a medida

Ref.	Descripción
1305	Ancho < 80 cm / Altura hasta 195 cm
1363	Ancho < 80 cm / Altura de 195 hasta 220 cm

Ref.	Descripción
1311	Ancho de 80 a 120 cm / Altura hasta 195 cm
1364	Ancho de 80 a 120 cm / Altura de 195 hasta 220 cm

Estos precios incluyen todos los componentes para su montaje excepto el brazo en el modelo Screen.

1313	Incremento FROST PLUS ancho < 80 cm
------	-------------------------------------

1315	Incremento FROST PLUS ancho 80-120 cm
------	---------------------------------------

Plazo de entrega 15 días.

Bisagras especiales + a medida

móvil Screen bisagra a medida

Descripción	TRANSPARENTE	FROST PLUS
	Ref.	Ref.
hasta 40 cm	1355	1357
de 40 a 80 cm	1356	1358

Plazo de entrega 15 días.

Ref.	Descripción
0862	Corte Escuadra/Cajonado



DISTINTOS ACABADOS EN SCREEN A MEDIDA 6 mm

nuevos brazos para Screen, Open y Glass

barra con 1 soporte + soporte lateral fijo



soporte sujeción a pared



soporte sujeción a fijo

Referencia	Descripción
1716	Barra 140 con un soporte (para frontal)
1716+1718	Barra 140 un soporte + soporte lateral fijo

barra con 2 soportes



soporte sujeción a lateral fijo
ref.1718

Referencia	Descripción
1717	Barra 200 con dos soportes (para frontal)
1717+1718	Barra 200 dos soportes + soporte lateral fijo



Referencia	Descripción
1716x2+1730	Barra apertura al vértice GLASS/OPEN



NOVEDAD

Referencia	Descripción
0012	Colgador GME



Referencia	Descripción
0188	Mástil a techo Screen

Altura máxima 260 cm



Referencia	Descripción
0184	Brazo 60-120 cm cuadrado recto/45°



Referencia	Descripción
1719	corner minimal 20x40 cm



GME

OPEN pg. 148



GLASS pg.182

GLASS PLEGABLE pg.198



ABATIBLES

**MAMPARAS
ABATIBLES**

open

Adaptándonos a tu espacio

Programa compuesto por fijos y puertas abatibles en diferentes medidas ideal para aprovechar al máximo el espacio en el cuarto de baño salvando los sanitarios y mobiliario.

Open está fabricada con perfiles de aluminio minimalista y cristales de 6 mm, además su diseño sin perfiles inferior y brazos de aluminio para garantizar su estabilidad la convierten en un programa totalmente actual y siguiendo las últimas tendencias.

Novedad: decorado FROST PLUS
Disponible Open Black en página 220





ABATIBLES

open COMBI A puerta con cierre imán a pared



COMBI A FREE

*Opción instalación formato free, rango -3cm

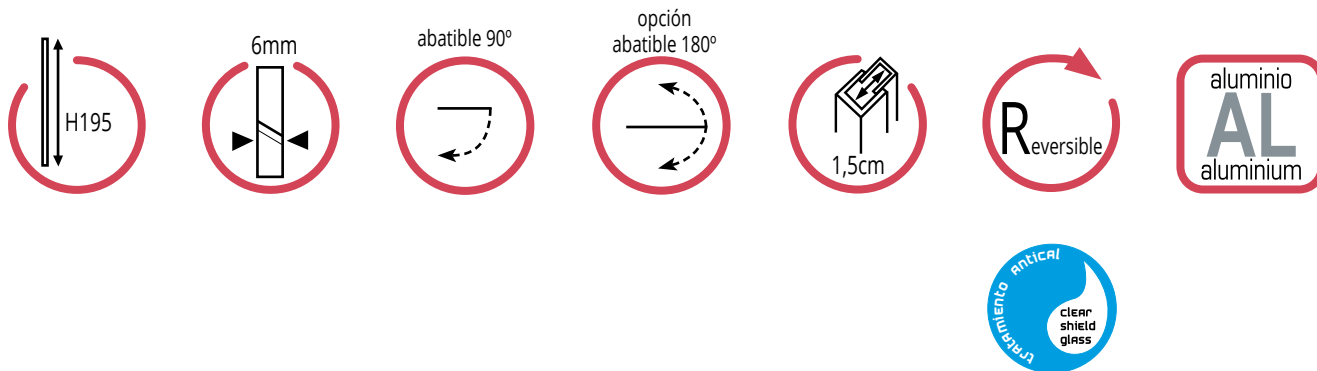

COMBI A

Medida	Rango cm	Apertura	TRANSPARENTE	FROST PLUS
			Referencias	Referencias
40	41,1 - 42,6	33	1216 + 1211	-
45	46,1 - 47,6	38	1217 + 1211	-
50	51,1 - 52,6	43	1207 + 1211	1284 + 1211
55	56,1 - 57,6	48	1218 + 1211	1285 + 1211
60	61,1 - 62,6	53	1219 + 1211	1286 + 1211
65	66,1 - 67,6	58	1208 + 1211	1287 + 1211
70	71,1 - 72,6	63	1209 + 1211	1288 + 1211
75	76,1 - 77,6	68	1220 + 1211	1289 + 1211
80	81,1 - 82,6	73	1210 + 1211	1290 + 1211
85	86,1 - 87,6	78	1223 + 1211	1291 + 1211

*Permite unión con laterales fijos STD en el lado de la puerta usando Ref. 1222 (rango mínimo +1,8 cm), ver pág. 180.

Ref.	Descripción	
1222	perfil expansor puerta (+1,5 a +3 cm)	
1211	perfil de pared open	
1215	perfil puerta (reduce hasta 1 cm el rango)	
1221	juego gomas imán expansión +1,2 cm	
1213	juego gomas apertura IN-OUT 180°	

open COMBI A + lat. fijo



Opción barra 140 cm más soporte lateral fijo - Ref. 1716+1718

Lat. fijos 6 mm

	TRANSPARENTE	FROST PLUS
Rango cm	Ref.	Ref.
66 - 69	1720	1292
76 - 79	1721	1293
86 - 89	1722	1294
Brazo Open	1214	

Referencias	Descripción
0218	perfil compensación +2 cm
0029	perfil compensación +4 cm
0219	perfil compensación +5,5 cm



Laterales fijos a medida 6 mm

	TRANSPARENTE	FROST PLUS
Descripción	Ref.	Ref.
lateral fijo a medida hasta 40 cm	1345	1345+1312
lateral fijo a medida de 40 hasta 80 cm	1316	1316+1313
lateral fijo a medida de 80 hasta 120 cm	1317	1317+1315

*Plazo de entrega 15 días.

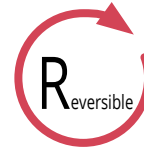
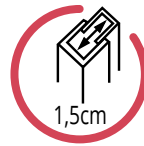
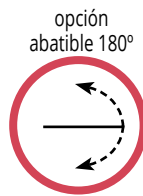
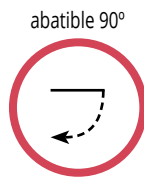
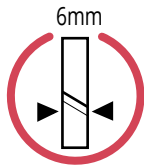
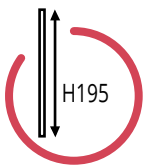

Medidas	Rango	TRANSPARENTE	FROST PLUS
		Referencia	Referencia
COMBI A + LATERAL FIJO 70 c/BRAZO 1214			
40X70	40,6-42,1/66-69	1216+1211+1720+1214	-
45X70	45,6-47,1/66-69	1217+1211+1720+1214	-
50X70	50,6-52,1/66-69	1207+1211+1720+1214	1284+1211+1292+1214
55X70	55,6-57,1/66-69	1218+1211+1720+1214	1285+1211+1292+1214
60X70	60,6-62,1/66-69	1219+1211+1720+1214	1286+1211+1292+1214
65X70	65,6-67,1/66-69	1208+1211+1720+1214	1287+1211+1292+1214
70X70	70,6-72,1/66-69	1209+1211+1720+1214	1288+1211+1292+1214
75X70	75,6-77,1/66-69	1220+1211+1720+1214	1289+1211+1292+1214
80X70	80,6-82,1/66-69	1210+1211+1720+1214	1290+1211+1292+1214
85X70	85,6-87,1/66-69	1223+1211+1720+1214	1291+1211+1292+1214
COMBI A + LATERAL FIJO 80 c/BRAZO 1214			
40X80	40,6-42,1/76-79	1216+1211+1721+1214	-
45X80	45,6-47,1/76-79	1217+1211+1721+1214	-
50X80	50,6-52,1/76-79	1207+1211+1721+1214	1284+1211+1293+1214
55X80	55,6-57,1/76-79	1218+1211+1721+1214	1285+1211+1293+1214
60X80	60,6-62,1/76-79	1219+1211+1721+1214	1286+1211+1293+1214
65X80	65,6-67,1/76-79	1208+1211+1721+1214	1287+1211+1293+1214
70X80	70,6-72,1/76-79	1209+1211+1721+1214	1288+1211+1293+1214
75X80	75,6-77,1/76-79	1220+1211+1721+1214	1289+1211+1293+1214
80X80	80,6-82,1/76-79	1210+1211+1721+1214	1290+1211+1293+1214
85X80	85,6-87,1/76-79	1223+1211+1721+1214	1291+1211+1293+1214
COMBI A + LATERAL FIJO 90 c/BRAZO 1214			
40X90	40,6-42,1/86-89	1216+1211+1722+1214	-
45X90	45,6-47,1/86-89	1217+1211+1722+1214	-
50X90	50,6-52,1/86-89	1207+1211+1722+1214	1284+1211+1294+1214
55X90	55,6-57,1/86-89	1218+1211+1722+1214	1285+1211+1294+1214
60X90	60,6-62,1/86-89	1219+1211+1722+1214	1286+1211+1294+1214
65X90	65,6-67,1/86-89	1208+1211+1722+1214	1287+1211+1294+1214
70X90	70,6-72,1/86-89	1209+1211+1722+1214	1288+1211+1294+1214
75X90	75,6-77,1/86-89	1220+1211+1722+1214	1289+1211+1294+1214
80X90	80,6-82,1/86-89	1210+1211+1722+1214	1290+1211+1294+1214
85X90	85,6-87,1/86-89	1223+1211+1722+1214	1291+1211+1294+1214

Las aperturas son las mismas que en los frontales.



apertura exterior a 90°

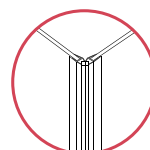

opción in-out p/fijo

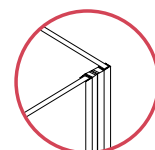

El rango del frontal en la apertura in-out aumenta en 1,4 cm y el rango del lateral fijo se reduce 1 cm Ref. 0038

open COMBI B puerta con cierre perfil imán



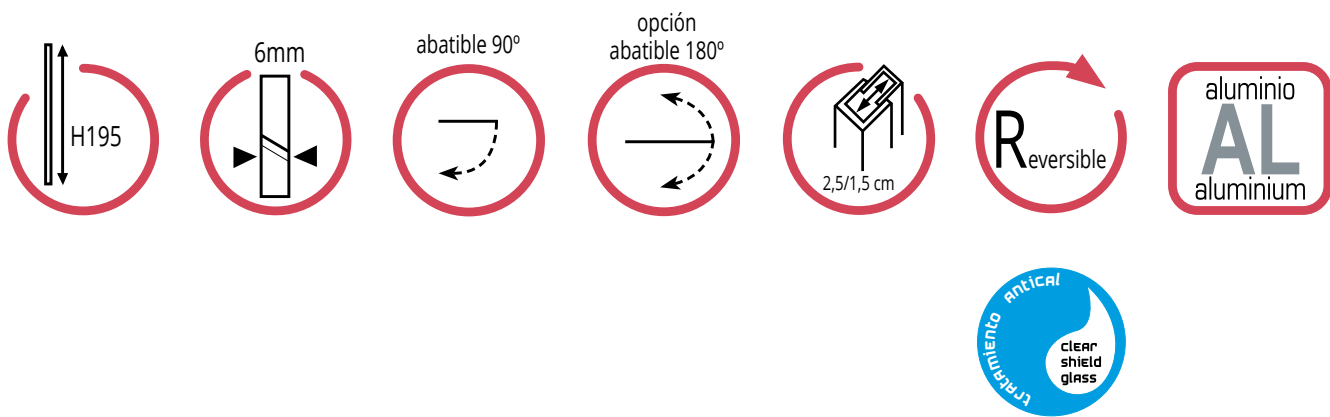

COMBI B

Medida	Rango cm	Apertura	TRANSPARENTE	FROST PLUS
			Referencias	Referencias
45	43,6 - 47,6	33	1216 + 1211 + 1212	-
50	48,6 - 52,6	38	1217 + 1211 + 1212	-
55	53,6 - 57,6	43	1207 + 1211 + 1212	1284 + 1211 + 1212
60	58,6 - 62,6	48	1218 + 1211 + 1212	1285 + 1211 + 1212
65	63,6 - 67,6	53	1219 + 1211 + 1212	1286 + 1211 + 1212
70	68,6 - 72,6	58	1208 + 1211 + 1212	1287 + 1211 + 1212
75	73,6 - 77,6	63	1209 + 1211 + 1212	1288 + 1211 + 1212
80	78,6 - 82,6	68	1220 + 1211 + 1212	1289 + 1211 + 1212
85	83,6 - 87,6	73	1210 + 1211 + 1212	1290 + 1211 + 1212
90	88,6 - 92,6	78	1223 + 1211 + 1212	1291 + 1211 + 1212

*Permite unión con laterales fijos STD en lado perfil cierre imán (rango mínimo +0,7 cm, expansión +1,5 cm), ver pág. 180.

*Permite unión con laterales fijos STD en lado puerta usando ref. 1222 (rango mínimo +1,8 cm, expansión +2,5 cm), ver pág. 180.

Ref.	Descripción
0218	perfil compensación lado cierre perfil imán +3 cm
0029	perfil compensación lado cierre perfil imán +6 cm
1212	perfil cierre imán
1211	perfil de pared open
1215	perfil puerta (reduce hasta 1 cm el rango), ver pág. 260
1221	juego gomas imán expansión +1,2 cm, ver pág. 260
1222	perfil expansor lado puerta +2,5 cm, ver pág. 260
1213	juego gomas apertura IN-OUT 180°



open COMBI C fijo + puerta abatible con cierre imán a pared



Opción barra 140 cm Ref. 1716

FIJOS	TRANSPARENTE	FROST PLUS	
	Rango cm	Ref.	Ref.
	17,5/20	1200	-
	22,5/25	1201	-
	27,5/30	1202	1280
	37,5/40	1203	1281
	47,5/50	1204	1282
	57,5/60	1205	1283

(2,5 ajuste)



Paneles fijos a medida (ver pág. 258)

PUERTAS	TRANSPARENTE	FROST PLUS	
	Medida cm	Ref.	Ref.
	40	1216	-
	45	1217	-
	50	1207	1284
	55	1218	1285
	60	1219	1286
	65	1208	1287
	70	1209	1288
	75	1220	1289
	80	1210	1290
	85	1223	1291

(sin ajuste)

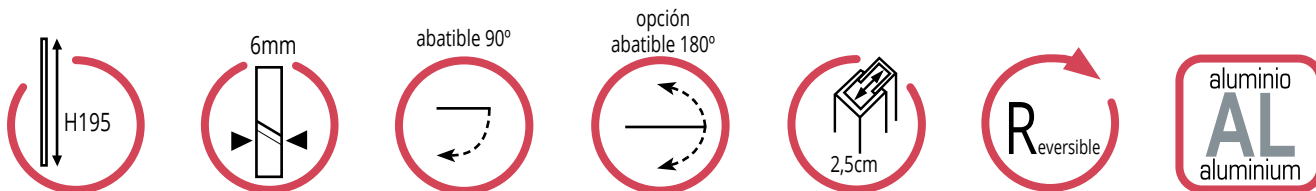

Combinación con puertas 50, 55, 65, 70, 80 y 85

COMBI C

Medidas	Rango	Fijo	Puerta	Apertura	TRANSPARENTE	FROST PLUS
					Ref.	Ref.
70	67,5 - 70	20	50	43	1200+1207	-
75	72,5 - 75	25	50	43	1201+1207	-
80	77,5 - 80	30	50	43	1202+1207	1280+1284
85	82,5 - 85	30	55	53	1202+1218	1280+1285
90	87,5 - 90	40	50	43	1203+1207	1281+1284
95	92,5 - 95	30	65	53	1202+1208	1280+1287
100	97,5 - 100	30	70	63	1202+1209	1280+1288
100	97,5 - 100	50	50	43	1204+1207	1282+1284
105	102,5 - 105	40	65	58	1203+1208	1281+1287
110	107,5 - 110	30	80	73	1202+1210	1280+1290
110	107,5 - 110	40	70	63	1203+1209	1281+1288
110	107,5 - 110	60	50	43	1205+1207	1283+1284
115	112,5 - 115	50	65	58	1204+1208	1282+1287
120	117,5 - 120	40	80	73	1203+1210	1281+1290
120	117,5 - 120	50	70	63	1204+1209	1282+1288
125	122,5 - 125	60	65	58	1205+1208	1283+1287
130	127,5 - 130	50	80	73	1204+1210	1282+1290
130	127,5 - 130	60	70	63	1205+1209	1283+1288
135	132,5 - 135	50	85	78	1204+1223	1282+1291
140	137,5 - 140	60	80	73	1205+1210	1283+1290
145	142,5 - 145	60	85	78	1205+1223	1283+1291

*Permite combinación con lateral fijo STD en lado fijo, rango mínimo +0,7 (sin ajuste), ver pág. 180

*Permite combinación con lateral fijo Glass en lado puerta, el rango del frontal se reduce 0,5 cm

Ref.	Descripción
0218	perfil compensación +3 cm lado fijo
0029	perfil compensación +6 cm lado fijo
1221	juego gomas imán expansión +1,2 cm, ver pág. 260
1213	juego gomas apertura IN-OUT 180°



open COMBI C + lat. fijo



Opción barra 140 cm más soporte lateral fijo - Ref. 1716+1718

laterales fijos 6 mm

Ref.	Descripción	Rango
1720	lateral fijo 70x195	66 - 69
1721	lateral fijo 80x195	76 - 79
1722	lateral fijo 90x195	86 - 89
1214	brazo open	

Referencias	Descripción
0218	perfil compensación +2 cm
0029	perfil compensación +4 cm
0219	perfil compensación +5,5 cm

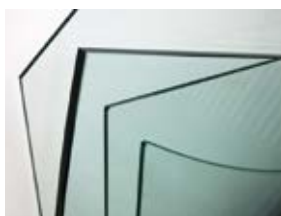

Laterales fijos TRANSPARENTES a medida 6 mm (más información en página 259)

Descripción	Ref.
lateral fijo a medida OPEN hasta 40 cm	1345
lateral fijo a medida OPEN de 40 hasta 80 cm	1316
lateral fijo a medida OPEN de 80 hasta 120 cm	1317

*Plazo de entrega 15 días.

COMBI C + LATERAL FIJO 70 c/BRAZO 1214

Medidas (F+A) xLF	Referencia	Rango
70 (20+50) x70	1200+1207+1720+1214	67-69,5/66-69
75 (25+50) x70	1201+1207+1720+1214	72-74,5/66-69
80 (30+50) x70	1202+1207+1720+1214	77-79,5/66-69
85 (20+65) x70	1200+1208+1720+1214	82-84,5/66-69
90 (20+70) x70	1200+1209+1720+1214	87-89,5/66-69
90 (25+65) x70	1201+1208+1720+1214	87-89,5/66-69
90 (40+50) x70	1203+1207+1720+1214	87-89,5/66-69
95 (25+70) x70	1201+1209+1720+1214	92-94,5/66-69
95 (30+65) x70	1202+1208+1720+1214	92-94,5/66-69
100 (20+80) x70	1200+1210+1720+1214	97-99,5/66-69
100 (30+70) x70	1202+1209+1720+1214	97-99,5/66-69
100 (50+50) x70	1204+1207+1720+1214	97-99,5/66-69
105 (25+80) x70	1201+1210+1720+1214	102-104,5/66-69
105 (40+65) x70	1203+1208+1720+1214	102-104,5/66-69
110 (30+80) x70	1202+1210+1720+1214	107-109,5/66-69
110 (40+70) x70	1203+1209+1720+1214	107-109,5/66-69
110 (60+50) x70	1205+1207+1720+1214	107-109,5/66-69
115 (50+65) x70	1204+1208+1720+1214	112-114,5/66-69
120 (40+80) x70	1203+1210+1720+1214	117-119,5/66-69
120 (50+70) x70	1204+1209+1720+1214	117-119,5/66-69
125 (60+65) x70	1205+1208+1720+1214	122-124,5/66-69
130 (50+80) x70	1204+1210+1720+1214	127-129,5/66-69
130 (60+70) x70	1205+1209+1720+1214	127-129,5/66-69
140 (60+80) x70	1205+1210+1720+1214	137-139,5/66-69
145 (60+85) x70	1205+1223+1720+1214	142-144,5/66-69

COMBI C + LATERAL FIJO 80 c/BRAZO 1214

Medidas (F+A) xLF	Referencia	Rango
70 (20+50) x80	1200+1207+1721+1214	67-69,5/76-79
75 (25+50) x80	1201+1207+1721+1214	72-74,5/76-79
80 (30+50) x80	1202+1207+1721+1214	77-79,5/76-79
85 (20+65) x80	1200+1208+1721+1214	82-84,5/76-79
90 (20+70) x80	1200+1209+1721+1214	87-89,5/76-79
90 (25+65) x80	1201+1208+1721+1214	87-89,5/76-79
90 (40+50) x80	1203+1207+1721+1214	87-89,5/76-79
95 (25+70) x80	1201+1209+1721+1214	92-94,5/76-79
95 (30+65) x80	1202+1208+1721+1214	92-94,5/76-79
100 (20+80) x80	1200+1210+1721+1214	97-99,5/76-79
100 (30+70) x80	1202+1209+1721+1214	97-99,5/76-79
100 (50+50) x80	1204+1207+1721+1214	97-99,5/76-79
105 (25+80) x80	1201+1210+1721+1214	102-104,5/76-79
105 (40+65) x80	1203+1208+1721+1214	102-104,5/76-79
110 (30+80) x80	1202+1210+1721+1214	107-109,5/76-79
110 (40+70) x80	1203+1209+1721+1214	107-109,5/76-79
110 (60+50) x80	1205+1207+1721+1214	107-109,5/76-79
115 (50+65) x80	1204+1208+1721+1214	112-114,5/76-79
120 (40+80) x80	1203+1210+1721+1214	117-119,5/76-79
120 (50+70) x80	1204+1209+1721+1214	117-119,5/76-79
125 (60+65) x80	1205+1208+1721+1214	122-124,5/76-79
130 (50+80) x80	1204+1210+1721+1214	127-129,5/76-79
130 (60+70) x80	1205+1209+1721+1214	127-129,5/76-79
140 (60+80) x80	1205+1210+1721+1214	137-139,5/76-79
145 (60+85) x80	1205+1223+1721+1214	142-144,5/76-79

apertura exterior

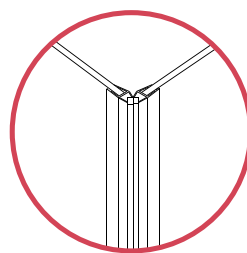

opción in-out p/fijo

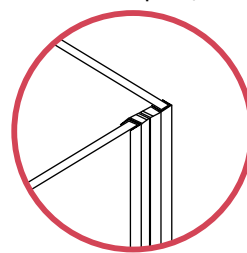

El rango del frontal en la apertura in-out aumenta en 1,4 cm y el rango del lateral fijo se reduce 1 cm Ref. 0038



Opción barra 140 cm más soporte lateral fijo - Ref. 1716+1718

COMBI C + LATERAL FIJO 90 c/BRAZO 1214

Medidas (F+A) xLF	Referencia	Rango
70 (20+50) x90	1200+1207+1722+1214	67-69,5/86-89
75 (25+50) x90	1201+1207+1722+1214	72-74,5/86-89
80 (30+50) x90	1202+1207+1722+1214	77-79,5/86-89
85 (20+65) x90	1200+1208+1722+1214	82-84,5/86-89
90 (20+70) x90	1200+1209+1722+1214	87-89,5/86-89
90 (25+65) x90	1201+1208+1722+1214	87-89,5/86-89
90 (40+50) x90	1203+1207+1722+1214	87-89,5/86-89
95 (25+70) x90	1201+1209+1722+1214	92-94,5/86-89
95 (30+65) x90	1202+1208+1722+1214	92-94,5/86-89
100 (20+80) x90	1200+1210+1722+1214	97-99,5/86-89
100 (30+70) x90	1202+1209+1722+1214	97-99,5/86-89
100 (50+50) x90	1204+1207+1722+1214	97-99,5/86-89
105 (25+80) x90	1201+1210+1722+1214	102-104,5/86-89
105 (40+65) x90	1203+1208+1722+1214	102-104,5/86-89
110 (30+80) x90	1202+1210+1722+1214	107-109,5/86-89
110 (40+70) x90	1203+1209+1722+1214	107-109,5/86-89
110 (60+50) x90	1205+1207+1722+1214	107-109,5/86-89
115 (50+65) x90	1204+1208+1722+1214	112-114,5/86-89
120 (40+80) x90	1203+1210+1722+1214	117-119,5/86-89
120 (50+70) x90	1204+1209+1722+1214	117-119,5/86-89
125 (60+65) x90	1205+1208+1722+1214	122-124,5/86-89
130 (50+80) x90	1204+1210+1722+1214	127-129,5/86-89
130 (60+70) x90	1205+1209+1722+1214	127-129,5/86-89
140 (60+80) x90	1205+1210+1722+1214	137-139,5/86-89
145 (60+85) x90	1205+1223+1722+1214	142-144,5/86-89

open frost plus COMBI C + lat. fijo



laterales fijos FROST PLUS 6 mm

Ref.	Descripción	Rango
1292	lateral fijo frost plus 70x195	66 - 69
1293	lateral fijo frost plus 80x195	76 - 79
1294	lateral fijo frost plus 90x195	86 - 89
1214	brazo open	

Referencias	Descripción
0218	perfil compensación +2 cm
0029	perfil compensación +4 cm
0219	perfil compensación +5,5 cm

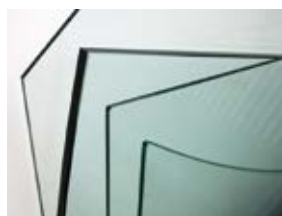

Laterales fijos FROST PLUS a medida 6 mm (más información en página 259)

Descripción	Ref.
lateral fijo a medida OPEN hasta 40 cm	1345+1312
lateral fijo a medida OPEN de 40 hasta 80 cm	1316+1313
lateral fijo a medida OPEN de 80 hasta 120 cm	1317+1315

*Plazo de entrega 15 días.

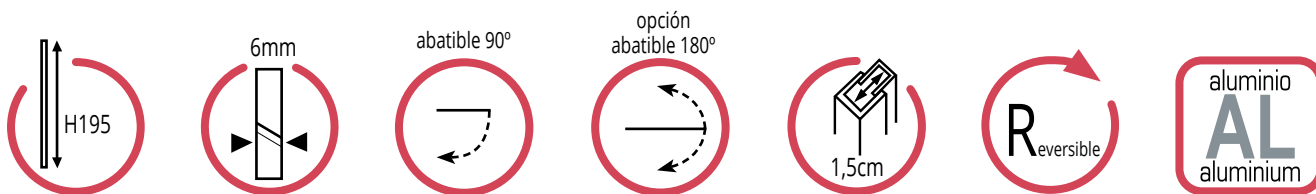

COMBI C + LATERAL FIJO 70 c/BRAZO 1214

Medidas (F+A) xLF	Referencia	Rango
80 (30+50) x70	1280+1284+1292+1214	77-79,5/66-69
85 (30+55) x70	1280+1285+1292+1214	82-84,5/66-69
90 (40+50) x70	1281+1284+1292+1214	87-89,5/66-69
95 (30+65) x70	1280+1287+1292+1214	92-94,5/66-69
100 (30+70) x70	1280+1288+1292+1214	97-99,5/66-69
100 (50+50) x70	1282+1284+1292+1214	97-99,5/66-69
105 (40+65) x70	1281+1287+1292+1214	102-104,5/66-69
110 (30+80) x70	1280+1290+1292+1214	107-109,5/66-69
110 (40+70) x70	1281+1288+1292+1214	107-109,5/66-69
110 (60+50) x70	1283+1284+1292+1214	107-109,5/66-69
115 (50+65) x70	1282+1287+1292+1214	112-114,5/66-69
120 (40+80) x70	1281+1290+1292+1214	117-119,5/66-69
120 (50+70) x70	1282+1288+1292+1214	117-119,5/66-69
125 (60+65) x70	1283+1287+1292+1214	122-124,5/66-69
130 (50+80) x70	1282+1290+1292+1214	127-129,5/66-69
130 (60+70) x70	1283+1288+1292+1214	127-129,5/66-69
135 (50+85) x70	1282+1291+1292+1214	132-134,5/66-69
140 (60+80) x70	1283+1290+1292+1214	137-139,5/66-69
145 (60+85) x70	1283+1291+1292+1214	142-144,5/66-69

apertura exterior

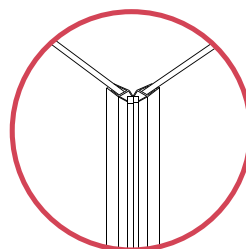

opción in-out p/fijo

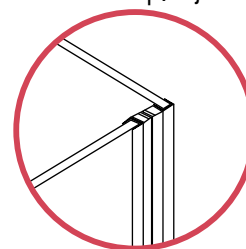

El rango del frontal en la apertura in-out aumenta en 1,4 cm y el rango del lateral fijo se reduce 1 cm
Ref. 0038



COMBI C + LATERAL FIJO 80 c/BRAZO 1214

Medidas (F+A) xLF	Referencia	Rango
80 (30+50) x80	1280+1284+1293+1214	77-79,5/76-79
85 (30+55) x80	1280+1285+1293+1214	82-84,5/76-79
90 (40+50) x80	1281+1284+1293+1214	87-89,5/76-79
95 (30+65) x80	1280+1287+1293+1214	92-94,5/76-79
100 (30+70) x80	1280+1288+1293+1214	97-99,5/76-79
100 (50+50) x80	1282+1284+1293+1214	97-99,5/76-79
105 (40+65) x80	1281+1287+1293+1214	102-104,5/76-79
110 (30+80) x80	1280+1290+1293+1214	107-109,5/76-79
110 (40+70) x80	1281+1288+1293+1214	107-109,5/76-79
110 (60+50) x80	1283+1284+1293+1214	107-109,5/76-79
115 (50+65) x80	1282+1287+1293+1214	112-114,5/76-79
120 (40+80) x80	1281+1290+1293+1214	117-119,5/76-79
120 (50+70) x80	1282+1288+1293+1214	117-119,5/76-79
125 (60+65) x80	1283+1287+1293+1214	122-124,5/76-79
130 (50+80) x80	1282+1290+1293+1214	127-129,5/76-79
130 (60+70) x80	1283+1288+1293+1214	127-129,5/76-79
135 (50+85) x80	1282+1291+1293+1214	132-134,5/76-79
140 (60+80) x80	1283+1290+1293+1214	137-139,5/76-79
145 (60+85) x80	1283+1291+1293+1214	142-144,5/76-79

COMBI C + LATERAL FIJO 90 c/BRAZO 1214

Medidas (F+A) xLF	Referencia	Rango
80 (30+50) x90	1280+1284+1294+1214	77-79,5/86-89
85 (30+55) x90	1280+1285+1294+1214	82-84,5/86-89
90 (40+50) x90	1281+1284+1294+1214	87-89,5/86-89
95 (30+65) x90	1280+1287+1294+1214	92-94,5/86-89
100 (30+70) x90	1280+1288+1294+1214	97-99,5/86-89
100 (50+50) x90	1282+1284+1294+1214	97-99,5/86-89
105 (40+65) x90	1281+1287+1294+1214	102-104,5/86-89
110 (30+80) x90	1280+1290+1294+1214	107-109,5/86-89
110 (40+70) x90	1281+1288+1294+1214	107-109,5/86-89
110 (60+50) x90	1283+1284+1294+1214	107-109,5/86-89
115 (50+65) x90	1282+1287+1294+1214	112-114,5/86-89
120 (40+80) x90	1281+1290+1294+1214	117-119,5/86-89
120 (50+70) x90	1282+1288+1294+1214	117-119,5/86-89
125 (60+65) x90	1283+1287+1294+1214	122-124,5/86-89
130 (50+80) x90	1282+1290+1294+1214	127-129,5/86-89
130 (60+70) x90	1283+1288+1294+1214	127-129,5/86-89
135 (50+85) x90	1282+1291+1294+1214	132-134,5/86-89
140 (60+80) x90	1283+1290+1294+1214	137-139,5/86-89
145 (60+85) x90	1283+1291+1294+1214	142-144,5/86-89

open COMBI D fijo + puerta abatible con cierre perfil imán



Opción barra 140 cm más soporte - Ref. 1716

FIJOS	TRANSPARENTE	FROST PLUS
Rango cm	Ref.	Ref.
17,5/20	1200	-
22,5/25	1201	-
27,5/30	1202	1280
37,5/40	1203	1281
47,5/50	1204	1282
57,5/60	1205	1283

(2,5 ajuste)

Cierre perfil imán ref.1212



Paneles fijos a medida (ver pág. 258)

PUERTAS	TRANSPARENTE	FROST PLUS
Rango cm	Ref.	Ref.
42,5/45	1216+1212	-
47,5/50	1217+1212	-
52,5/55	1207+1212	1284+1212
57,5/60	1218+1212	1285+1212
62,5/65	1219+1212	1286+1212
67,5/70	1208+1212	1287+1212
72,5/75	1209+1212	1288+1212
77,5/80	1220+1212	1289+1212
82,5/85	1210+1212	1290+1212
87,5/90	1223+1212	1291+1212

(2,5 ajuste)

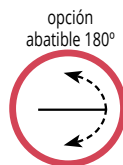
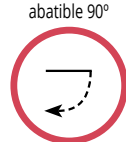
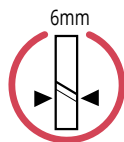
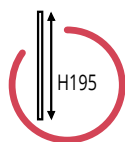

Combinación con puertas 50, 55, 65, 70, 80 y 85

COMBI D

Medidas	Rango	Fijo	Puerta	Apert.
70	70 - 75	20	50	43
75	75 - 80	25	50	43
80	80 - 85	30	50	43
85	85 - 90	30	55	48
90	90 - 95	40	50	43
95	95 - 100	30	65	53
100	100 - 105	30	70	63
100	100 - 105	50	50	43
105	105 - 110	40	65	58
110	110 - 115	30	80	73
110	110 - 115	40	70	63
110	110 - 115	60	50	43
115	115 - 120	50	65	58
120	120 - 125	40	80	73
120	120 - 125	50	70	63
125	125 - 130	60	65	58
130	130 - 135	50	80	73
130	130 - 135	60	70	63
135	135 - 140	50	85	78
140	140 - 145	60	80	73
145	145 - 150	60	85	78

TRANSPARENTE	FROST PLUS
Referencia	Referencia
1200+1207+1212	-
1201+1207+1212	-
1202+1207+1212	1280+1284+1212
1202+1218+1212	1280+1285+1212
1203+1207+1212	1281+1284+1212
1202+1208+1212	1280+1287+1212
1202+1209+1212	1280+1288+1212
1204+1207+1212	1282+1284+1212
1203+1208+1212	1281+1287+1212
1202+1210+1212	1280+1290+1212
1203+1209+1212	1281+1288+1212
1205+1207+1212	1283+1284+1212
1204+1208+1212	1282+1287+1212
1203+1210+1212	1281+1290+1212
1204+1209+1212	1282+1288+1212
1205+1208+1212	1283+1287+1212
1204+1210+1212	1282+1290+1212
1205+1209+1212	1283+1288+1212
1204+1223+1212	1282+1291+1212
1205+1210+1212	1283+1290+1212
1205+1223+1212	1283+1291+1212

*Permite uso perfil compensación en ambos lados

*Permite combinación con lateral fijo STD, rango mínimo +0,7 / expansión 2,5 cm (ver pág. 180)

Ref.	Descripción
0218	perfil compensación lado fijo +3 cm
0029	perfil compensación lado fijo +6 cm
1221	juego gomas imán expansión +1,2 cm, ver pág. 260
1213	juego gomas apertura IN-OUT 180°



Opción barra 140 cm Ref. 1716.

open COMBI E fijo + puerta abatible con cierre a fijo



Opción barra 140 más soporte Ref. 1716

COMBI E

FIJOS	Ref.	Rango cm
FIJO 20	1200	17,5/20
FIJO 25	1201	22,5/25
FIJO 30	1202	27,5/30
FIJO 40	1203	37,5/40
FIJO 50	1204	47,5/50
FIJO 60	1205	57,5/60

(2,5 ajuste)

Perfil pared ref. 1211



Paneles fijos a medida (ver pág. 258)

PUERTAS	Ref.	Rango cm
PUERTA 40	1216 + 1211	41,1/42,6
PUERTA 45	1217 + 1211	46,1/47,6
PUERTA 50	1207 + 1211	51,1/52,6
PUERTA 55	1218 + 1211	56,1/57,6
PUERTA 60	1219 + 1211	61,1/62,6
PUERTA 65	1208 + 1211	66,1/67,6
PUERTA 70	1209 + 1211	71,1/72,6
PUERTA 75	1220 + 1211	76,1/77,6
PUERTA 80	1210 + 1211	81,1/82,6
PUERTA 85	1223 + 1211	86,1/87,6

(1,5 ajuste)

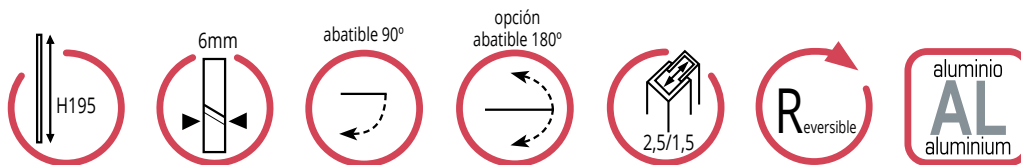

COMBI E

Medidas	Fijo	Puerta	Referencia	Apertura	Rango
70	20	50	1200+1207+1211	43	68,6 - 72,6
75	25	50	1201+1207+1211	43	73,6 - 77,6
80	30	50	1202+1207+1211	43	78,6 - 82,6
85	20	65	1200+1208+1211	58	83,6 - 87,6
90	40	50	1203+1207+1211	43	88,6 - 92,6
90	25	65	1201+1208+1211	58	88,6 - 92,6
90	20	70	1200+1209+1211	63	88,6 - 92,6
95	25	70	1201+1209+1211	63	93,6 - 97,6
95	30	65	1202+1208+1211	58	93,6 - 97,6
100	30	70	1202+1209+1211	63	98,6 - 102,6
100	20	80	1200+1210+1211	73	98,6 - 102,6
100	50	50	1204+1207+1211	43	98,6 - 102,6
105	25	80	1201+1210+1211	73	103,6 - 107,6
105	40	65	1203+1208+1211	58	103,6 - 107,6
110	30	80	1202+1210+1211	73	108,6 - 112,6
110	40	70	1203+1209+1211	63	108,6 - 112,6
110	60	50	1205+1207+1211	43	108,6 - 112,6
115	50	65	1204+1208+1211	58	113,6 - 117,6
120	40	80	1203+1210+1211	73	118,6 - 122,6
120	50	70	1204+1209+1211	63	118,6 - 122,6
125	60	65	1205+1208+1211	58	123,6 - 127,6
130	50	80	1204+1210+1211	73	128,6 - 132,6
130	60	70	1205+1209+1211	63	128,6 - 132,6
135	50	85	1204+1223+1211	78	133,6 - 137,6
140	60	80	1205+1210+1211	73	138,6 - 142,6
145	60	85	1205+1223+1211	78	143,6 - 147,6

*Permite combinación con lateral fijo STD en lado fijo, rango mínimo +0,7 / expansión 1,5 cm (ver pág. 180)

*Permite unión con lateral fijo STD en lado puerta usando ref. 1222, rango mínimo +1,8 cm / ajuste 2,5 cm (ver pág. 180)

Ref.	Descripción
0218	perfil compensación lado fijo +3 cm
0029	perfil compensación lado fijo +6 cm
1215	perfil puerta (reduce hasta 1 cm el rango), ver pág. 260
1221	juego gomas imán expansión +1,2 cm, ver pág. 260
1222	perfil expansor puerta +2,5 cm, ver pág. 260
1213	juego gomas apertura IN-OUT 180°

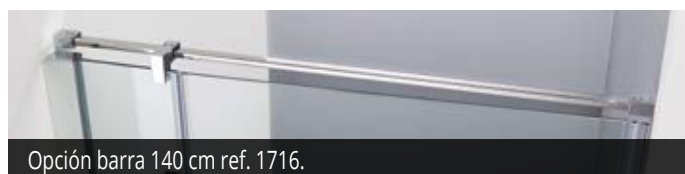

Opción barra 140 cm ref. 1716.

open COMBI F fijo + puerta abatible + fijo



Opción barra 200 más soportes Ref. 1717

COMBI F

FIJOS	Ref.	Rango cm	PUERTAS	Ref.	Medida cm
FIJO 20	1200	17,5/20	PUERTA 40	1216	40
FIJO 25	1201	22,5/25	PUERTA 45	1217	45
FIJO 30	1202	27,5/30	PUERTA 50	1207	50
FIJO 40	1203	37,5/40	PUERTA 55	1218	55
FIJO 50	1204	47,5/50	PUERTA 60	1219	60
FIJO 60	1205	57,5/60	PUERTA 65	1208	65
(ajuste 2,5x2 = 5cm)			PUERTA 70	1209	70
			PUERTA 75	1220	75
			PUERTA 80	1210	80
			PUERTA 85	1223	85



Paneles fijos a medida (ver pág. 258)



COMBI F Combinación puertas 50, 65, 70 y 80

Medidas (F+P+F)	Referencia	Ap.	Rango
90 (20+50+20)	1200+1207+1200	43	85 - 90
95 (20+50+25)	1200+1207+1201	43	90 - 95
100 (25+50+25)	1201+1207+1201	43	95 - 100
100 (20+50+30)	1200+1207+1202	43	95 - 100
105 (25+50+30)	1201+1207+1202	43	100 - 105
105 (20+65+20)	1200+1208+1200	58	100 - 105
110 (20+65+25)	1200+1208+1201	58	105 - 110
110 (20+70+20)	1200+1209+1200	63	105 - 110
110 (30+50+30)	1202+1207+1202	43	105 - 110
115 (20+65+30)	1200+1208+1202	58	110 - 115
115 (20+70+25)	1200+1209+1201	63	110 - 115
120 (30+50+40)	1202+1207+1203	43	115 - 120
120 (25+65+30)	1201+1208+1202	58	115 - 120
120 (20+70+30)	1200+1209+1202	63	115 - 120
120 (20+80+20)	1200+1210+1200	73	115 - 120
125 (20+65+40)	1200+1208+1203	58	120 - 125
125 (30+65+30)	1202+1208+1202	58	120 - 125
125 (25+70+30)	1201+1209+1202	63	120 - 125
125 (25+80+20)	1201+1210+1200	73	120 - 125
130 (25+65+40)	1201+1208+1203	58	125 - 130
130 (20+70+40)	1200+1209+1203	63	125 - 130
130 (30+70+30)	1202+1209+1202	63	125 - 130
130 (20+80+30)	1200+1210+1202	73	125 - 130
130 (20+50+60)	1200+1207+1205	43	125 - 130
135 (20+65+50)	1200+1208+1204	58	130 - 135
135 (30+65+40)	1202+1208+1203	58	130 - 135
135 (25+70+40)	1201+1209+1203	63	130 - 135
135 (25+80+30)	1201+1210+1202	73	130 - 135
135 (25+50+60)	1201+1207+1205	43	130 - 135
140 (25+65+50)	1201+1208+1204	58	135 - 140
140 (20+70+50)	1200+1209+1204	63	135 - 140
140 (30+70+40)	1202+1209+1203	63	135 - 140
140 (20+80+40)	1200+1210+1203	73	135 - 140
140 (30+80+30)	1202+1210+1202	73	135 - 140
140 (30+50+60)	1202+1207+1205	43	135 - 140
145 (30+65+50)	1202+1208+1204	58	140 - 145
145 (40+65+40)	1203+1208+1203	58	140 - 145

COMBI F Combinación puertas 50, 65, 70 y 80

Medidas (F+P+F)	Referencia	Ap.	Rango
145 (25+70+50)	1201+1209+1204	63	140 - 145
145 (25+80+40)	1201+1210+1203	73	140 - 145
145 (20+65+60)	1200+1208+1205	58	140 - 145
150 (40+50+60)	1203+1207+1205	43	145 - 150
150 (25+65+60)	1201+1208+1205	58	145 - 150
150 (20+70+60)	1200+1209+1205	63	145 - 150
150 (30+70+50)	1202+1209+1204	63	145 - 150
150 (40+70+40)	1203+1209+1203	63	145 - 150
150 (30+80+40)	1202+1210+1203	73	145 - 150
150 (20+80+50)	1200+1210+1204	73	145 - 150
155 (30+65+60)	1202+1208+1205	58	150 - 155
155 (25+70+60)	1201+1209+1205	63	150 - 155
155 (40+65+50)	1203+1208+1204	58	150 - 155
155 (25+80+50)	1201+1210+1204	73	150 - 155
160 (50+50+60)	1204+1207+1205	43	155 - 160
160 (30+70+60)	1202+1209+1205	63	155 - 160
160 (40+70+50)	1203+1209+1204	63	155 - 160
160 (30+80+50)	1202+1210+1204	73	155 - 160
160 (20+80+60)	1200+1210+1205	73	155 - 160
160 (40+80+40)	1203+1210+1203	73	155 - 160
165 (40+65+60)	1203+1208+1205	58	160 - 165
165 (50+65+50)	1204+1208+1204	58	160 - 165
165 (25+80+60)	1201+1210+1205	73	160 - 165
170 (60+50+60)	1205+1207+1205	43	165 - 170
170 (40+70+60)	1203+1209+1205	63	165 - 170
170 (50+70+50)	1204+1209+1204	63	165 - 170
170 (30+80+60)	1202+1210+1205	73	165 - 170
170 (40+80+50)	1203+1210+1204	73	165 - 170
175 (50+65+60)	1204+1208+1205	58	170 - 175
180 (50+70+60)	1204+1209+1205	63	175 - 180
180 (40+80+60)	1203+1210+1205	73	175 - 180
180 (50+80+50)	1204+1210+1204	73	175 - 180
185 (60+65+60)	1205+1208+1205	58	180 - 185
190 (60+70+60)	1205+1209+1205	63	185 - 190
190 (50+80+60)	1204+1210+1205	73	185 - 190
200 (60+80+60)	1205+1210+1205	73	195 - 200

*Permite unión con lateral fijo STD en ambos lados (rango mínimo +0,7 cm / ajuste 2,5 cm), ver pág. 180.

*Permite uso perfil compensación en ambos lados

Ref.	Descripción
0218	perfil compensación lado fijo +3 cm
0029	perfil compensación lado fijo +6 cm
1221	juego gomas imán expansión +1,2 cm, ver pág. 260
1213	juego gomas apertura IN-OUT 180°

open COMBI G fijo + 2 puertas abatibles + fijo



Opción barra 200 más soportes Ref. 1717

FIJOS

	TRANSPARENTE	FROST PLUS
Rango cm	Ref.	Ref.
17,5/20	1200	-
22,5/25	1201	-
27,5/30	1202	1280
37,5/40	1203	1281
47,5/50	1204	1282
57,5/60	1205	1283

(ajuste 2,5x2 = 5cm)



Paneles fijos a medida (ver pág. 258)

PUERTAS

	TRANSPARENTE	FROST PLUS
Medida cm	Ref.	Ref.
2 PUERTAS 76,2	1206	-
38,1	1216	-
43,1	1217	-
48,1	1207	1284
53,1	1218	1285
58,1	1219	1286
63,1	1208	1287
68,1	1209	1288
73,1	1220	1289
78,1	1210	1290
83,1	1223	1291

COMBI G

Combinación con puertas 50, 65, 70 y 80

Medidas (F+P+P+F)	Referencia	Rango
115 (20+40+40+20)	1200x2+1206	111,2 - 116,2
120 (20+40+40+25)	1200+1201+1206	116,2 - 121,2
125 (20+40+40+30)	1200+1202+1206	121,2 - 126,2
125 (25+40+40+25)	1201x2+1206	121,2 - 126,2
130 (25+40+40+30)	1201+1202+1206	126,2 - 131,2
135 (20+50+50+20)	1200x2+1207x2	131,2 - 136,2
135 (30+40+40+30)	1202x2+1206	131,2 - 136,2
140 (25+40+40+40)	1201+1203+1206	136,2 - 141,2
140 (20+50+50+25)	1200+1201+1207x2	136,2 - 141,2
145 (20+50+50+30)	1200+1202+1207x2	141,2 - 146,2
145 (30+40+40+40)	1202+1203+1206	141,2 - 146,2
150 (25+50+50+30)	1201+1202+1207x2	146,2 - 151,2
150 (25+40+40+50)	1201+1204+1206	146,2 - 151,2

COMBI G

Combinación con puertas 50, 65, 70 y 80

Medidas (F+P+P+F)	Referencia	Rango
155 (20+50+50+40)	1200+1203+1207x2	151,2 - 156,2
155 (30+50+50+30)	1202x2+1207x2	151,2 - 156,2
155 (40+40+40+40)	1203x2+1206	151,2 - 156,2
155 (20+40+40+60)	1200+1205+1206	151,2 - 156,2
160 (25+40+40+60)	1201+1205+1206	156,2 - 161,2
160 (25+50+50+40)	1201+1203+1207x2	156,2 - 161,2
165 (30+40+40+60)	1202+1205+1206	161,2 - 166,2
165 (30+50+50+40)	1202+1203+1207x2	161,2 - 166,2
165 (20+65+65+20)	1200x2+1208x2	161,2 - 166,2
165 (40+40+40+50)	1203+1204+1206	161,2 - 166,2
170 (20+65+65+25)	1200+1201+1208x2	166,2 - 171,2
175 (40+40+40+60)	1203+1205+1206	171,2 - 176,2
175 (30+50+50+50)	1202+1204+1207x2	171,2 - 176,2

COMBI G

Combinación con puertas 50, 65, 70 y 80

Medidas (F+P+P+F)	Referencia	Rango
175 (40+50+50+40)	1203x2+1207x2	171,2 - 176,2
175 (20+50+50+60)	1200+1205+1207x2	171,2 - 176,2
175 (20+65+65+30)	1200+1202+1208x2	171,2 - 176,2
175 (20+70+70+20)	1200x2+1209x2	171,2 - 176,2
175 (50+40+40+50)	1204x2+1206	171,2 - 176,2
180 (25+50+50+60)	1201+1205+1207x2	176,2 - 181,2
180 (25+65+65+30)	1201+1202+1208x2	176,2 - 181,2
180 (20+70+70+25)	1200+1201+1209x2	176,2 - 181,2
185 (50+40+40+60)	1204+1205+1206	181,2 - 186,2
185 (40+50+50+50)	1203+1204+1207x2	181,2 - 186,2
185 (30+50+50+60)	1202+1205+1207x2	181,2 - 186,2
185 (30+65+65+30)	1202x2+1208x2	181,2 - 186,2
185 (25+70+70+25)	1201x2+1209x2	181,2 - 186,2
185 (20+70+70+30)	1200+1202+1209x2	181,2 - 186,2
190 (25+65+65+40)	1201+1203+1208x2	186,2 - 191,2
190 (25+70+70+30)	1201+1202+1209x2	186,2 - 191,2
195 (60+40+40+60)	1205x2+1206	191,2 - 196,2
195 (50+50+50+50)	1204x2+1207x2	191,2 - 196,2
195 (40+50+50+60)	1203+1205+1207x2	191,2 - 196,2
195 (20+65+65+50)	1200+1204+1208x2	191,2 - 196,2
195 (30+65+65+40)	1202+1203+1208x2	191,2 - 196,2
195 (30+70+70+30)	1202x2+1209x2	191,2 - 196,2
195 (20+70+70+40)	1200+1203+1209x2	191,2 - 196,2
195 (20+80+80+20)	1200x2+1210x2	191,2 - 196,2
200 (25+65+65+50)	1201+1204+1208x2	196,2 - 201,2
200 (25+70+70+40)	1201+1203+1209x2	196,2 - 201,2
200 (25+80+80+20)	1201+1200+1210x2	196,2 - 201,2
205 (20+65+65+60)	1200+1205+1208x2	201,2 - 206,2
205 (40+65+65+40)	1203x2+1208x2	201,2 - 206,2
205(30+65+65+50)	1202+1204+1208x2	201,2 - 206,2
205 (30+70+70+40)	1202+1203+1209x2	201,2 - 206,2
205 (20+70+70+50)	1200+1204+1209x2	201,2 - 206,2
205 (50+50+50+60)	1204+1205+1207x2	201,2 - 206,2
205 (20+80+80+30)	1200+1202+1210x2	201,2 - 206,2
210 (25+65+65+60)	1201+1205+1208x2	206,2 - 211,2
210 (25+70+70+50)	1201+1204+1209x2	206,2 - 211,2
210 (25+80+80+30)	1201+1202+1210x2	206,2 - 211,2

COMBI G

Combinación con puertas 50, 65, 70 y 80

Medidas (F+P+P+F)	Referencia	Rango
215 (30+65+65+60)	1202+1205+1208x2	211,2 - 216,2
215 (40+65+65+50)	1203+1204+1208x2	211,2 - 216,2
215 (20+70+70+60)	1200+1205+1209x2	211,2 - 216,2
215 (30+70+70+50)	1202+1204+1209x2	211,2 - 216,2
215 (40+70+70+40)	1203x2+1209x2	211,2 - 216,2
215 (30+80+80+30)	1202x2+1210x2	211,2 - 216,2
215 (20+80+80+40)	1200+1203+1210x2	211,2 - 216,2
215 (25+70+70+60)	1201+1205+1209x2	216,2 - 221,2
215 (60+50+50+60)	1205x2+1207x2	211,2 - 216,2
220 (25+80+80+40)	1201+1203+1210x2	216,2 - 221,2
225 (50+65+65+50)	1204x2+1208x2	221,2 - 226,2
225 (40+65+65+60)	1203+1205+1208x2	221,2 - 226,2
225 (30+70+70+60)	1202+1205+1209x2	221,2 - 226,2
225 (40+70+70+50)	1203+1204+1209x2	221,2 - 226,2
225 (20+80+80+50)	1200+1204+1210x2	221,2 - 226,2
225 (30+80+80+40)	1202+1203+1210x2	221,2 - 226,2
230 (25+80+80+50)	1201+1204+1210x2	226,2 - 231,2
235 (50+65+65+60)	1204+1205+1208x2	231,2 - 236,2
235 (40+70+70+60)	1203+1205+1209x2	231,2 - 236,2
235 (50+70+70+50)	1204x2+1209x2	231,2 - 236,2
235 (20+80+80+60)	1200+1205+1210x2	231,2 - 236,2
235 (40+80+80+40)	1203x2+1210x2	231,2 - 236,2
240 (25+80+80+60)	1201+1205+1210x2	236,2 - 241,2
245 (60+65+65+60)	1205x2+1208x2	241,2 - 246,2
245 (50+70+70+60)	1204+1205+1209x2	241,2 - 246,2
245 (30+80+80+60)	1202+1205+1210x2	241,2 - 246,2
245 (40+80+80+50)	1203+1204+1210x2	241,2 - 246,2
255 (60+70+70+60)	1205x2+1209x2	251,2 - 256,2
255 (40+80+80+60)	1203+1205+1210x2	251,2 - 256,2
255 (50+80+80+50)	1204x2+1210x2	251,2 - 256,2
265 (50+80+80+60)	1204+1205+1210x2	261,2 - 266,2
275 (60+80+80+60)	1205x2+1210x2	271,2 - 276,2

COMBINACIONES FROST PLUS

*Permite unión con lateral fijo STD en ambos lados (rango mínimo +0,7 cm / ajuste 2,5 cm), ver pág. 180.

*Permite uso perfil compensación en ambos lados

Ref.	Descripción
0218	perfil compensación lado fijo +3 cm
0029	perfil compensación lado fijo +6 cm
1221	juego gomas imán expansión +1,2 cm, ver pág. 260

open COMBI H angular 2 puertas abatibles + 2 fijos



Opción barras más soportes Ref. 1716x2+1730

FIJOS	TRANSPARENTE	FROST PLUS
Rango cm	Ref.	Ref.
17,5/20	1200	-
22,5/25	1201	-
27,5/30	1202	1280
37,5/40	1203	1281
47,5/50	1204	1282
57,5/60	1205	1283

(2,5 ajuste)



Paneles fijos a medida (ver pág. 258)

PUERTAS	TRANSPARENTE	FROST PLUS
Medida cm	Ref.	Ref.
2 PUERTAS 76,2	1206	-
39,5	1216	-
44,5	1217	-
49,5	1207	1284
54,5	1218	1285
59,5	1219	1286
64,5	1208	1287
69,5	1209	1288
74,5	1220	1289
79,5	1210	1290
84,5	1223	1291

(sin ajuste)



COMBI H

Combinación con puertas 40, 50, 65, 70 y 80

Medidas (F+P+P+F)	Referencia	Rango
70x70(30+40+40+30)	1202x2+1206	67-69,5
70x70(20+50+50+20)	1200x2+1207x2	67-69,5
75x75(25+50+50+25)	1201x2+1207x2	72-74,5
80x80(40+40+40+40)	1203x2+1206	77-79,5
80x80(30+50+50+30)	1202x2+ 1207x2	77-79,5
85x85(20+65+65+20)	1200x2+1208x2	82-85,5
90x90(50+40+40+50)	1204x2+1206	87-89,5
90x90(40+50+50+40)	1203x2+1207x2	87-89,5
90x90(25+65+65+25)	1201x2+1208x2	87-89,5
90x90(20+70+70+20)	1200x2+1209x2	87-89,5
95x95(30+65+65+30)	1202x2+1208x2	92-94,5
100x100(60+40+40+60)	1205x2+1206	97-99,5
100x100(30+70+70+30)	1202x2+1209x2	97-99,5
100x100(50+50+50+50)	1204x2+1207x2	97-99,5
90x70(50+40+40+30)	1204+1202+1206	87-89,5 / 67-69,5
90x70(40+50+50+20)	1203+1200+1207x2	87-89,5 / 67-69,5
90x70(25+65+50+20)	1201+1208+1200+1207	87-89,5 / 67-69,5
90x70(20+70+50+20)	1200x2+1209+1207	87-89,5 / 67-69,5
95x70(30+65+50+20)	1202+1208+1200+1207	92-94,5 / 67-69,5
95x70(25+70+50+20)	1201+1209+1200+1207	92-94,5 / 67-69,5
100x70(60+40+40+30)	1205+1202+1206	97-99,5 / 67-69,5
100x70(30+70+50+20)	1202+1209+1200+1207	97-99,5 / 67-69,5
100x70(20+80+50+20)	1200x2+1210+1207	97-99,5 / 67-69,5
105x70(40+65+50+20)	1203+1208+1200+1207	102-104,5 / 67-69,5
105x70(25+80+50+20)	1201+1210+1200+1207	102-104,5 / 67-69,5
110x70(40+70+50+20)	1203+1209+1200+1207	107-109,5 / 67-69,5
110x70(30+80+50+20)	1202+1210+1200+1207	107-109,5 / 67-69,5
110x70(60+50+50+20)	1205+1207+1200+1207	107-109,5 / 67-69,5
115x70(50+65+50+20)	1204+1208+1200+1207	112-114,5 / 67-69,5
120x70(50+70+50+20)	1204+1209+1200+1207	117-119,5 / 67-69,5
120x70(40+80+50+20)	1203+1210+1200+1207	117-119,5 / 67-69,5

*Permite uso perfil compensación en ambos lados

Ref.	Descripción
0218	perfil compensación lado fijo +3 cm
0029	perfil compensación lado fijo +6 cm

COMBI H

Combinación con puertas 40, 50, 65, 70 y 80

Medidas (F+P+P+F)	Referencia	Rango
125x70(60+65+50+20)	1205+1208+1200+1207	122-124,5 / 67-69,5
130x70(50+80+50+20)	1204+1210+1200+1207	127-129,5 / 67-69,5
130x70(60+70+50+20)	1205+1209+1200+1207	127-129,5 / 67-69,5
140x70(60+80+50+20)	1205+1210+1200+1207	137-139,4 / 67-69,5
90x80(50+40+40+40)	1204+1203+1206	87-89,5 / 77-79,5
90x80(40+50+50+30)	1203+1202+1207x2	87-89,5 / 77-79,5
90x80(25+65+50+30)	1201+1208+1202+1207	87-89,5 / 77-79,5
90x80(20+70+50+30)	1200+1209+1207+1202	87-89,5 / 77-79,5
95x80(30+65+50+30)	1202+1208+1202+1207	92-94,5 / 77-79,5
95x80(25+70+50+30)	1201+1209+1202+1207	92-94,5 / 77-79,5
100x80(60+40+40+40)	1205+1203+1206	97-99,5 / 77-79,5
100x80(30+70+50+30)	1202+1209+1202+1207	97-99,5 / 77-79,5
100x80(20+80+50+30)	1210+1200+1202+1207	97-99,5 / 77-79,5
105x80(40+65+50+30)	1203+1208+1202+1207	102-104,5 / 77-79,5
105x80(25+80+50+30)	1201+1210+1202+1207	102-104,5 / 77-79,5
110x80(60+50+50+30)	1205+1207+1202+1207	107-109,5 / 77-79,5
110x80(40+70+50+30)	1203+1209+1202+1207	107-109,5 / 77-79,5
110x80(30+80+50+30)	1202x2+1210+1207	107-109,5 / 77-79,5
115x80(50+65+50+30)	1204+1208+1202+1207	112-114,5 / 77-79,5
120x80(50+70+50+30)	1204+1209+1202+1207	117-119,5 / 77-79,5
120x80(40+80+50+30)	1203+1210+1202+1207	117-119,5 / 77-79,5
125x80(60+65+50+30)	1205+1208+1202+1207	122-124,5 / 77-79,5
130x80(50+80+50+30)	1204+1210+1202+1207	127-129,5 / 77-79,5
130x80(60+70+50+30)	1205+1209+1202+1207	127-129,5 / 77-79,5
140x80(60+80+50+30)	1205+1210+1202+1207	137-139,5 / 77-79,5
95x90(30+65+50+40)	1202+1208+1203+1207	92-94,5 / 87-89,5
95x90(25+70+50+40)	1201+1209+1203+1207	92-94,5 / 87-89,5
95x90(30+65+65+25)	1202+1201+1208x2	92-94,5 / 87-89,5
95x90(25+70+65+25)	1201+1209+1201+1208	92-94,5 / 87-89,5
95x90(30+65+70+20)	1202+1208+1200+1209	92-94,5 / 87-89,5
95x90(25+70+70+20)	1201+1200+1209x2	92-94,5 / 87-89,5

COMBINACIONES FROST PLUS

open COMBI H angular 2 puertas abatibles + 2 fijos



Opción barras + soportes Ref. 1716x2+1730

FIJOS

Rango cm	TRANSPARENTE Ref.	FROST PLUS Ref.
17,5/20	1200	-
22,5/25	1201	-
27,5/30	1202	1280
37,5/40	1203	1281
47,5/50	1204	1282
57,5/60	1205	1283

(2,5 ajuste)



Paneles fijos a medida (ver pág. 258)

PUERTAS

Medida cm	TRANSPARENTE Ref.	FROST PLUS Ref.
2 PUERTAS 76,2	1206	-
39,5	1216	-
44,5	1217	-
49,5	1207	1284
54,5	1218	1285
59,5	1219	1286
64,5	1208	1287
69,5	1209	1288
74,5	1220	1289
79,5	1210	1290
84,5	1223	1291

(sin ajuste)



COMBI H

Combinación con puertas 40, 50, 65, 70 y 80

Medidas (F+P+P+F)	Referencia	Rango
100x90(60+40+40+50)	1205+1204+1206	97-99,5 / 87-89,5
100x90(30+70+50+40)	1202+1209+1203+1207	97-99,5 / 87-89,5
100x90(20+80+50+40)	1200+1210+1203+1207	97-99,5 / 87-89,5
100x90(30+70+65+25)	1202+1209+1201+1208	97-99,5 / 87-89,5
100x90(20+80+65+25)	1200+1210+1201+1208	97-99,5 / 87-89,5
100x90(30+70+70+20)	1202+1200+1209x2	97-99,5 / 87-89,5
100x90(20+80+70+20)	1200x2+1210+1209	97-99,5 / 87-89,5
105x90(40+65+50+40)	1203x2+1208+1207	102-104,5 / 87-89,5
105x90(25+80+50+40)	1201+1210+1203+1207	102-104,5 / 87-89,5
105x90(40+65+65+25)	1203+1201+1208x2	102-104,5 / 87-89,5
105x90(25+80+65+25)	1201x2+1210+1208	102-104,5 / 87-89,5
105x90(40+65+70+20)	1203+1208+1200+1209	102-104,5 / 87-89,5
105x90(25+80+70+20)	1201+1210+1200+1209	102-104,5 / 87-89,5
110x90(60+50+50+40)	1205+1203+1207x2	107-109,5 / 87-89,5
110x90(40+70+50+40)	1203x2+1209+1207	107-109,5 / 87-89,5
110x90(30+80+50+40)	1202+1210+1203+1207	107-109,5 / 87-89,5
110x90(60+50+65+25)	1205+1207+1201+1208	107-109,5 / 87-89,5
110x90(40+70+65+25)	1203+1209+1201+1208	107-109,5 / 87-89,5
110x90(30+80+65+25)	1202+1210+1201+1208	107-109,5 / 87-89,5
110x90(60+50+70+20)	1205+1207+1200+1209	107-109,5 / 87-89,5
110x90(40+70+70+20)	1203+1200+1209x2	107-109,5 / 87-89,5
110x90(30+80+70+20)	1202+1210+1200+1209	107-109,5 / 87-89,5

*Permite uso perfil compensación en ambos lados

Ref.	Descripción
0218	perfil compensación lado fijo +3 cm
0029	perfil compensación lado fijo +6 cm

COMBI H

Combinación con puertas 40, 50, 65, 70 y 80

Medidas (F+P+P+F)	Referencia	Rango
115x90(50+65+50+40)	1204+1208+1203+1207	112-114,5 / 87-89,5
115x90(50+65+65+25)	1204+1201+1208x2	112-114,5 / 87-89,5
115x90(50+65+70+20)	1204+1208+1200+1209	112-114,5 / 87-89,5
120x90(50+70+50+40)	1204+1209+1203+1207	117-119,5 / 87-89,5
120x90(40+80+50+40)	1203x2+1210+1207	117-119,5 / 87-89,5
120x90(50+70+65+25)	1204+1209+1201+1208	117-119,5 / 87-89,5
120x90(40+80+65+25)	1203+1210+1201+1208	117-119,5 / 87-89,5
120x90(50+70+70+20)	1204+1200+1209x2	117-119,5 / 87-89,5
120x90(40+80+70+20)	1203+1210+1200+1209	117-119,5 / 87-89,5
125x90(60+65+50+40)	1205+1208+1203+1207	122-124,5 / 87-89,5
125x90(60+65+65+25)	1205+1201+1208x2	122-124,5 / 87-89,5
125x90(60+65+70+20)	1205+1208+1200+1209	122-124,5 / 87-89,5
130x90(60+70+50+40)	1205+1209+1203+1207	127-129,5 / 87-89,5
130x90(50+80+50+40)	1204+1210+1203+1207	127-129,5 / 87-89,5
130x90(60+70+65+25)	1205+1209+1201+1208	127-129,5 / 87-89,5
130x90(50+80+65+25)	1204+1210+1201+1208	127-129,5 / 87-89,5
130x90(60+70+70+20)	1205+1200+1209x2	127-129,5 / 87-89,5
130x90(50+80+70+20)	1204+1210+1200+1209	127-129,5 / 87-89,5
140x90(60+80+50+40)	1205+1210+1203+1207	137-139,5 / 87-89,5
140x90(60+80+65+25)	1205+1210+1201+1208	137-139,5 / 87-89,5
140x90(60+80+70+20)	1205+1210+1200+1209	137-139,5 / 87-89,5

COMBINACIONES FROST PLUS



Opción barras + soportes Ref. 1716x2+1730

open COMBI I 2 puertas abatibles



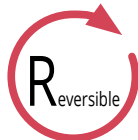
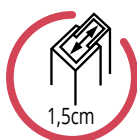
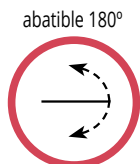
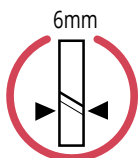
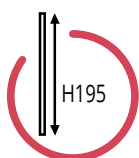

COMBI I

Medidas	Rango	Apert.	TRANSPARENTE	FROST PLUS
			Referencias	Referencias
80 (40+40)	79 - 82	66	1206+1211x2	-
85 (40+45)	84 - 87	71	1216+1217+1211x2	-
90 (45+45)	89 - 92	76	1217x2+1211x2	-
95 (45+50)	94 - 97	81	1217+1207+1211x2	-
100 (50+50)	99 - 102	86	1207x2+1211x2	1284x2+1211x2
105 (50+55)	104 - 107	91	1207+1218+1211x2	1284+1285+1211x2
110 (55+55)	109 - 112	96	1218x2+1211x2	1285x2+1211x2
115 (55+60)	114 - 117	101	1218+1219+1211x2	1285+1286+1211x2
120 (60+60)	119 - 122	106	1219x2+1211x2	1286x2+1211x2
125 (60+65)	124 - 127	111	1219+1208+1211x2	1286+1287+1211x2
130 (65+65)	129 - 132	116	1208x2+1211x2	1287x2+1211x2
135 (65+70)	134 - 137	121	1208+1209+1211x2	1287+1288+1211x2
140 (70+70)	139 - 142	126	1209x2+1211x2	1288x2+1211x2
145 (70+75)	144 - 147	131	1209+1220+1211x2	1288+1289+1211x2
150 (75+75)	149 - 152	136	1220x2+1211x2	1289x2+1211x2
155 (75+80)	154 - 157	141	1220+1210+1211x2	1289+1290+1211x2
160 (80+80)	159 - 162	146	1210x2+1211x2	1290x2+1211x2
165 (80+85)	164 - 167	151	1210+1223+1211x2	1290+1291+1211x2
170 (85+85)	169 - 172	156	1223x2+1211x2	1291x2+1211x2

*Permite unión con lateral fijo STD con ref. 1222 (rango mínimo +1,8 / expansión 1,5), ver pág. 180.

Ref.	Descripción
1221	juego gomas imán expansión +1,2 cm, ver pág. 260
1222	perfil expansor puerta +2,5 cm, ver pág. 260
1215	perfil puerta (reduce hasta 1 cm el rango), pág. 260

open COMBI J 2 puertas abatibles + fijo



Opción barra 200 más soportes Ref. 1717

FIJOS	TRANSPARENTE	FROST PLUS
Rango cm	Ref.	Ref.
17,5/20	1200	-
22,5/25	1201	-
27,5/30	1202	1280
37,5/40	1203	1281
47,5/50	1204	1282
57,5/60	1205	1283
(2,5 ajuste)		
Perfil puerta ref. 1211		



Paneles fijos a medida (ver pág. 258)

PUERTAS	TRANSPARENTE	FROST PLUS
Medida cm	Ref.	Ref.
2 PUERTAS 76,2	1206	-
38,6	1216	-
43,6	1217	-
48,6	1207	1284
53,6	1218	1285
58,6	1219	1286
63,6	1208	1287
68,6	1209	1288
73,6	1220	1289
78,6	1210	1290
83,6	1223	1291
(1,5 ajuste)		

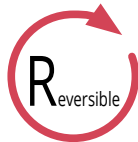
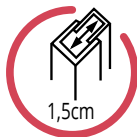
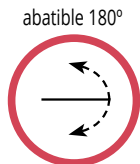
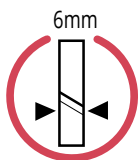
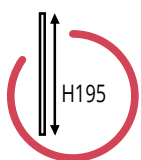

COMBI J

Medidas (P+P+F)	Rango	Apert.	TRANSPARENTE	FROST PLUS
			Referencias	Referencias
95 (40+40+20)	94,8/98,8	66	1206+1200+1211	-
100 (40+40+25)	99,8/103,8	66	1206+1201+1211	-
105 (40+40+30)	104,8/108,8	66	1206+1202+1211	-
110 (45+45+25)	109,8/113,8	76	1217X2+1201+1211	-
115 (45+45+30)	114,8/118,8	76	1217X2+1202+1211	-
120 (50+50+25)	119,8/123,8	86	1207X2+1201+1211	-
125 (50+50+30)	124,8/128,8	86	1207X2+1202+1211	1284X2+1280+1211
130 (50+55+30)	129,8/133,8	91	1207+1218+1202+1211	1284+1285+1280+1211
135 (50+50+40)	134,8/138,8	86	1207X2+1203+1211	1284X2+1281+1211
140 (60+55+30)	139,8/143,8	101	1219+1218+1202+1211	1286+1285+1280+1211
145 (45+45+60)	144,8/148,8	76	1217X2+1205+1211	-
145 (50+50+50)	144,8/148,8	86	1207X2+1204+1211	1284X2+1282+1211
150 (60+60+30)	149,8/153,8	106	1219X2+1202+1211	1286X2+1280+1211
155 (55+55+50)	154,8/158,8	96	1218X2+1204+1211	1285X2+1282+1211
160 (60+55+50)	159,8/163,8	101	1219+1218+1204+1211	1286+1285+1282+1211
165 (65+65+40)	164,8/168,8	116	1208X2+1203+1211	1287X2+1281+1211
170 (75+70+30)	169,8/173,8	131	1220+1209+1202+1211	1289+1288+1280+1211
175 (75+75+30)	174,8/178,8	136	1220X2+1202+1211	1289X2+1280+1211
180 (80+75+30)	179,8/183,8	141	1210+1220+1202+1211	1290+1289+1280+1211
185 (80+80+30)	184,8/188,8	146	1210X2+1202+1211	1290X2+1280+1211
190 (65+70+60)	189,8/193,8	121	1208+1209+1205+1211	1287+1288+1283+1211
195 (75+75+50)	194,8/198,8	136	1220X2+1204+1211	1289X2+1282+1211
200 (65+80+60)	199,8/203,8	131	1208+1210+1205+1211	1287+1290+1283+1211
205 (80+80+50)	204,8/208,8	146	1210X2+1204+1211	1290X2+1282+1211
210 (80+75+60)	209,8/213,8	141	1220+1210+1205+1211	1289+1290+1283+1211
215 (80+80+60)	214,8/218,8	146	1210X2+1205+1211	1290X2+1283+1211

*Permite combinación con lateral fijo STD en lado puerta usando ref.1222, rango mínimo +1,8 / expansión 2,5 cm (ver pág. 180)

*Permite combinación con lateral fijo STD en lado del fijo, rango mínimo +0,7 / expansión 1,5 cm (ver pág. 180)

Ref.	Descripción
0218	perfil compensación lado fijo +3 cm
0029	perfil compensación lado fijo +6 cm
1215	perfil puerta (reduce hasta 1 cm el rango), ver pág. 260
1221	juego gomas imán expansión +1,2 cm, ver pág. 260
1222	perfil expansor puerta +2,5 cm, ver pág. 260
1213	juego gomas apertura IN-OUT 180°

open COMBI K 2 puertas angular



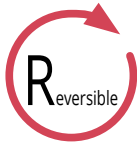
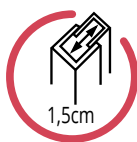
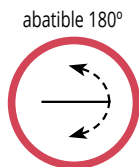
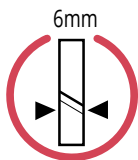
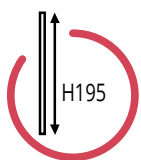

COMBI K

Medidas (P+P)	Rango	Apert.	TRANSPARENTES	FROST PLUS
			Referencias	Referencias
40x40	40,4-41,9 / 40,4-41,9	66	1211x2 +1206	-
40x45	40,4-41,9 / 45,4-46,9	71	1211x2 +1216+1217	-
45x45	45,4-46,9 / 45,4-46,9	76	1211x2+1217x2	-
45x50	45,4-46,9 / 50,4-51,9	81	1211x2+1217+1207	-
45x55	45,4-46,9 / 55,4-56,9	86	1211x2+1217+1218	-
45x60	45,4-46,9 / 60,4-61,9	91	1211x2+1217+1219	-
45x65	45,4-46,9 / 65,4-66,9	96	1211x2+1217+1208	-
45x70	45,4-46,9 / 70,4-71,9	101	1211x2+1217+1209	-
45x75	45,4-46,9 / 75,4-76,9	106	1211x2+1217+1220	-
45x80	45,4-46,9 / 80,4-81,9	111	1211x2+1217+1210	-
50x50	50,4-51,9 / 50,4-51,9	86	1211x2 + 1207x2	1211x2 + 1284x2
50x55	50,4-51,9 / 55,4-56,9	91	1211x2+1207+1218	1211x2+1284+1285
50x60	50,4-51,9 / 60,4-61,9	96	1211x2+1207+1219	1211x2+1284+1286
50x65	50,4-51,9 / 65,4-66,9	101	1211x2+1207+1208	1211x2+1284+1287
50x70	50,4-51,9 / 70,4-71,9	106	1211x2+1207+1209	1211x2+1284+1288
50x75	50,4-51,9 / 75,4-76,9	111	1211x2+1207+1220	1211x2+1284+1289
50x80	50,4-51,9 / 80,4-81,9	116	1211x2+1207+1210	1211x2+1284+1290
55x55	55,4-56,9 / 55,4-56,9	96	1211x2+1218x2	1211x2+1285x2
55x60	55,4-56,9 / 60,4-61,9	101	1211x2+1218+1219	1211x2+1285+1286
55x65	55,4-56,9 / 65,4-66,9	106	1211x2+1218+1208	1211x2+1285+1287
55x70	55,4-56,9 / 70,4-71,9	111	1211x2+1218+1209	1211x2+1285+1288
55x75	55,4-56,9 / 75,4-76,9	116	1211x2+1218+1220	1211x2+1285+1289
55x80	55,4-56,9 / 80,4-81,9	121	1211x2+1218+1210	1211x2+1285+1290
60x60	60,4-61,9 / 60,4-61,9	106	1211x2+1219x2	1211x2+1286x2
60x65	60,4-61,9 / 65,4-66,9	111	1211x2+1219+1208	1211x2+1286+1287
60x70	60,4-61,9 / 70,4-71,9	116	1211x2+1219+1209	1211x2+1286+1288
60x75	60,4-61,9 / 75,4-76,9	121	1211x2+1219+1220	1211x2+1286+1289
60x80	60,4-61,9 / 80,4-81,9	126	1211x2+1219+1210	1211x2+1286+1290
65x65	65,4-66,9 / 65,4-66,9	116	1211x2+1208x2	1211x2+1287x2
65x70	65,4-66,9 / 70,4-71,9	121	1211x2+1208+1209	1211x2+1287+1288
65x75	65,4-66,9 / 75,4-76,9	126	1211x2+1208+1220	1211x2+1287+1289
65x80	65,4-66,9 / 80,4-81,9	131	1211x2+1208+1210	1211x2+1287+1290
70x70	70,4-71,9 / 70,4-71,9	126	1211x2+1209x2	1211x2+1288x2
70x75	70,4-71,9 / 75,4-76,9	131	1211x2+1209+1220	1211x2+1288+1289
70x80	70,4-71,9 / 80,4-81,9	136	1211x2+1209+1210	1211x2+1288+1290
75x75	75,4-76,9 / 75,4-76,9	136	1211x2+1220x2	1211x2+1289x2
75x80	75,4-76,9 / 80,4-81,9	141	1211x2+1220+1210	1211x2+1289+1290
80x80	80,4-81,9 / 80,4-81,9	146	1211x2+1210x2	1211x2+1290x2
80x85	80,4-81,9 / 85,4-86,9	151	1210+1223+1211x2	1290+1291+1211x2
85x85	85,4-86,9 / 85,4-86,9	156	1223x2+1211x2	1291x2+1211x2

1222 perfil compensación lado puerta +2,5 cm, ver pág. 260

1215 perfil puerta (reduce hasta 1 cm el rango), ver pág. 260

open

lateral fijo STD TRANSPARENTE

a panel fijo

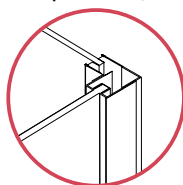

a cierre perfil imán

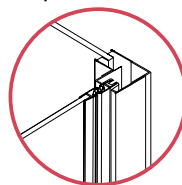

a puerta abatible

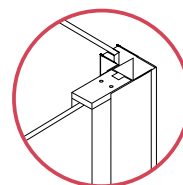

Combi E 30+70 + lat. fijo STD 70
Refs. 1202+1209+1211+0814+1214



Si la unión es al lado fijo o al cierre perfil imán ref. 1212, se sumaran +0,7 cm al rango mín. de la combinación + expansión del lado libre de lateral fijo.
La expansión del lado donde va el lateral fijo se pierde.

Si la unión es al lado puerta se debe utilizar la ref. 1222, se sumaran +1,8 cm al rango mínimo de la combinación + expansión del lado libre de lateral fijo.

Disponible para combinaciones

COMBI A
lado
perfil
puerta



COMBI B
ambos
lados

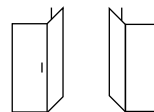

COMBI C
lado fijo

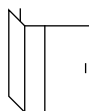

COMBI D
ambos
lados

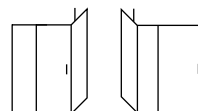

COMBI E
ambos
lados

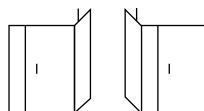

COMBI F
ambos
lados

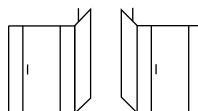

COMBI G
ambos
lados

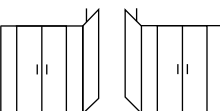

COMBI I
ambos
lados

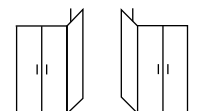

COMBI J
ambos
lados

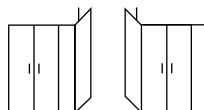

laterales fijos STD TRANSPARENTES 8 mm

Referencias	Descripción	Rango
0810+1214	lateral fijo STD 30x195 + brazo	26 - 29
0811+1214	lateral fijo STD 40x195 + brazo	36 - 39
0812+1214	lateral fijo STD 50x195 + brazo	46 - 49
0813+1214	lateral fijo STD 60x195 + brazo	56 - 59
0814+1214	lateral fijo STD 70x195 + brazo	66 - 69
0820+1214	lateral fijo STD 75x195 + brazo	71 - 74
0815+1214	lateral fijo STD 80x195 + brazo	76 - 79
0816+1214	lateral fijo STD 90x195 + brazo	86 - 89



Opción barra paralela 140 cm ref. 1716+1718+5568

Opción barra paralela 200 cm ref. 1717+1718+5568

Referencias	Descripción
0218	perfil compensación +2 cm
0029	perfil compensación +4 cm
0219	perfil compensación +5,5 cm

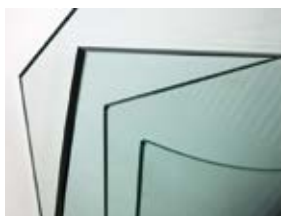

Laterales fijos a medida STD TRANSPARENTE 8 mm (más información en página 259)

Referencias	Descripción
1343+1214	lateral fijo a medida STD hasta 40 cm + brazo
1304+1214	lateral fijo a medida STD de 40 hasta 80 cm + brazo
1310+1214	lateral fijo a medida STD de 80 hasta 120 cm + brazo

*Plazo de entrega 15 días

open

lateral fijo STD FROST PLUS

a panel fijo

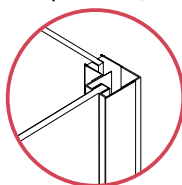

a cierre perfil imán

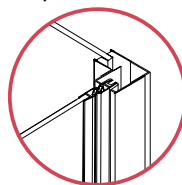

a puerta abatible

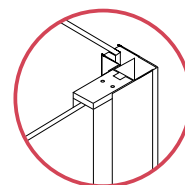

Combi C Frost 30+70 + lat. fijo Frost STD 70 + barra paralela
Refs. 1280+1288+1211+0817+1716+1718+5568



Si la unión es al lado fijo o al cierre perfil imán ref. 1212, se sumaran +0,7 cm al rango mín. de la combinación + expansión del lado libre de lateral fijo.
La expansión del lado donde va el lateral fijo se pierde.

Si la unión es al lado puerta se debe utilizar la ref. 1222, se sumaran +1,8 cm al rango mínimo de la combinación + expansión del lado libre de lateral fijo.

Disponible para combinaciones

COMBI A
lado perfil puerta



COMBI B
ambos lados

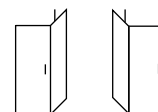

COMBI C
lado fijo

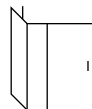

COMBI D
ambos lados

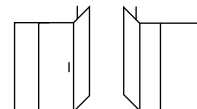

COMBI G
ambos lados

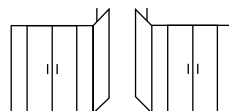

COMBI I
ambos lados

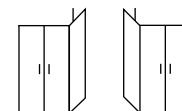

COMBI J
ambos lados

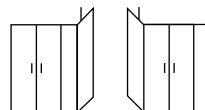

laterales fijos STD FROST PLUS 8 mm

Referencias	Descripción	Rango
0817+1214	lateral fijo STD 70x195 + brazo	66 - 69
0818+1214	lateral fijo STD 80x195 + brazo	76 - 79
0819+1214	lateral fijo STD 90x195 + brazo	86 - 89

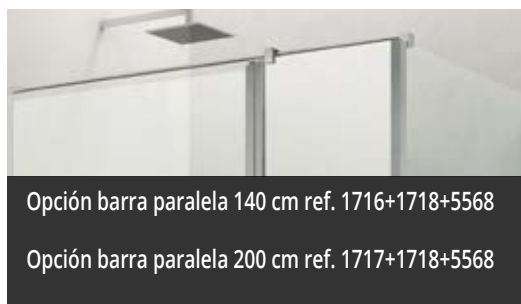

Opción barra paralela 140 cm ref. 1716+1718+5568

Opción barra paralela 200 cm ref. 1717+1718+5568

Referencias	Descripción
0218	perfil compensación +2 cm
0029	perfil compensación +4 cm
0219	perfil compensación +5,5 cm

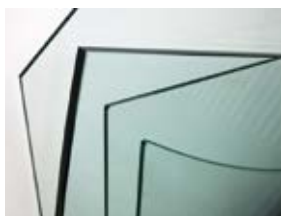

Laterales fijos a medida STD FROST PLUS 8 mm (más información en página 259)

Referencias	Descripción
1343+1312+1214	lateral fijo a medida STD hasta 40 cm + brazo
1304+1313+1214	lateral fijo a medida STD de 40 hasta 80 cm + brazo
1310+1315+1214	lateral fijo a medida STD de 80 hasta 120 cm + brazo

*Plazo de entrega 15 días

ABATIBLES

glass

Adaptándonos a tu espacio con bisagras

Programa compuesto por fijos y puertas abatibles con bisagra en diferentes medidas ideal para aprovechar al máximo el espacio en el cuarto de baño salvando los sanitarios y mobiliario.

Glass está fabricada con perfilera de aluminio minimalista, bisagras en latón cromado y cristales de 8/6 mm. Además, su diseño sin perfilera inferior y brazos de aluminio para garantizar su estabilidad, la convierten en un programa totalmente actual y siguiendo las últimas tendencias.

Novedad:
Puertas de 35 y 45.





ABATIBLES

glass fijo + puerta abatible con cierre imán a pared



Opción barra 140 cm Ref. 1716

COMBI C

FIJOS	Ref.	Rango
FIJO 20	1700	17/20
FIJO 25	1701	22/25
FIJO 30	1702	27/30
FIJO 40	1703	37/40
FIJO 50	1704	47/50
FIJO 60	1705	57/60

(3 cm ajuste)

PUERTAS	Ref.	Medida
PUERTA 30	1725	30
PUERTA 35	1727	35
PUERTA 40	1726	40
PUERTA 45	1728	45
PUERTA 50	1706	50
PUERTA 65	1707	65
PUERTA 70	1708	70
PUERTA 80	1709	80

(sin ajuste)



Paneles fijos y puertas a medida ver pág. 258



COMBI C

Medidas	Fijo	Puerta	Apertura	Referencia	Rango
70	20	50	47	1700+1706	67 - 70
75	25	50	47	1701+1706	72 - 75
80	30	50	47	1702+1706	77 - 80
85	20	65	62	1700+1707	82 - 85
90	25	65	62	1701+1707	87 - 90
90	20	70	67	1700+1708	87 - 90
90	40	50	47	1703+1706	87 - 90
95	25	70	67	1701+1708	92 - 95
95	30	65	62	1702+1707	92 - 95
100	30	70	67	1702+1708	97 - 100
100	50	50	47	1704+1706	97 - 100
100	20	80	77	1700+1709	97 - 100
105	25	80	77	1701+1709	102 - 105
105	40	65	62	1703+1707	102 - 105
110	30	80	77	1702+1709	107 - 110
110	40	70	67	1703+1708	107 - 110
110	60	50	47	1705+1706	107 - 110
115	50	65	62	1704+1707	112 - 115
120	40	80	77	1703+1709	117 - 120
120	50	70	67	1704+1708	117 - 120
125	60	65	62	1705+1707	122 - 125
130	50	80	77	1704+1709	127 - 130
130	60	70	67	1705+1708	127 - 130
140	60	80	77	1705+1709	137 - 140

*Permite combinación con lateral fijo STD en lado fijo, rango mínimo +0,7 (sin ajuste), ver pág. 201.

*Permite combinación con lateral fijo Glass en lado puerta, el rango del frontal se reducirá en 0,5 cm. Expansión 3 cm.

Referencias	Descripción
0218	perfil compensación +2 cm lado fijo
0029	perfil compensación +4 cm lado fijo
1221	imán expansión +1,2 cm (ver pág. 260)



Opción barra 140 cm Ref. 1716.



COMBI C FREE

*Opción instalación formato free, rango -3cm

glass COMBI C + lat. fijo



laterales fijos GLASS 6 mm

Referencias	Descripción	Rango
1720	lateral fijo 70x195	66 - 69
1721	lateral fijo 80x195	76 - 79
1722	lateral fijo 90x195	86 - 89
1715	brazo orientable	

Referencias	Descripción
0218	perfil compensación +2 cm
0029	perfil compensación +4 cm
0219	perfil compensación +5,5 cm

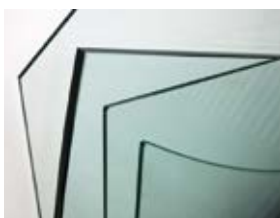

Laterales fijos a medida 6 mm (más información en página 259)

Referencias	Descripción
1345	lateral fijo a medida OPEN hasta 40 cm
1316	lateral fijo a medida OPEN de 40 hasta 80 cm
1317	lateral fijo a medida OPEN de 80 hasta 120 cm

*Plazo de entrega 15 días

COMBI C + LATERAL FIJO 70 c/BRAZO 1715

Medidas (F+A) xLF	Referencia	Rango
70 (20+50) x70	1700+1706+1720+1715	66,5-69,5/66-69
75 (25+50) x70	1701+1706+1720+1715	71,5-74,5/66-69
80 (30+50) x70	1702+1706+1720+1715	76,5-79,5/66-69
85 (20+65) x70	1700+1707+1720+1715	81,5-84,5/66-69
90 (25+65) x70	1701+1707+1720+1715	86,5-89,5/66-69
90 (20+70) x70	1700+1708+1720+1715	86,5-89,5/66-69
90 (40+50) x70	1703+1706+1720+1715	86,5-89,5/66-69
95 (25+70) x70	1701+1708+1720+1715	91,5-94,5/66-69
95 (30+65) x70	1702+1707+1720+1715	91,5-94,5/66-69
100 (30+70) x70	1702+1708+1720+1715	96,5-99,5/66-69
100 (50+50) x70	1704+1706+1720+1715	96,5-99,5/66-69
100 (20+80) x70	1700+1709+1720+1715	96,5-99,5/66-69
105 (25+80) x70	1701+1709+1720+1715	101,5-104,5/66-69
105 (40+65) x70	1703+1707+1720+1715	101,5-104,5/66-69
110 (30+80) x70	1702+1709+1720+1715	106,5-109,5/66-69
110 (40+70) x70	1703+1708+1720+1715	106,5-109,5/66-69
110 (60+50) x70	1705+1706+1720+1715	106,5-109,5/66-69
115 (50+65) x70	1704+1707+1720+1715	111,5-114,5/66-69
120 (40+80) x70	1703+1709+1720+1715	116,5-119,5/66-69
120 (50+70) x70	1704+1708+1720+1715	116,5-119,5/66-69
125 (60+65) x70	1705+1707+1720+1715	121,5-124,5/66-69
130 (50+80) x70	1704+1709+1720+1715	126,5-129,5/66-69
130 (60+70) x70	1705+1708+1720+1715	126,5-129,5/66-69
140 (60+80) x70	1705+1709+1720+1715	136,5-139,5/66-69

cierre imán - imán

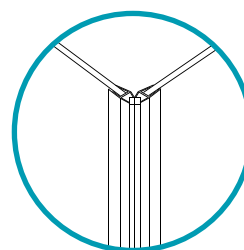

*El rango del frontal se reduce 0,5 cm



Opción barra 140 cm más soporte lateral fijo - Ref. 1716+1718

COMBI C + LATERAL FIJO 80 c/BRAZO 1715

Medidas (F+A) xLF	Referencia	Rango
70 (20+50) x80	1700+1706+1721+1715	66,5-69,5/76-79
75 (25+50) x80	1701+1706+1721+1715	71,5-74,5/76-79
80 (30+50) x80	1702+1706+1721+1715	76,5-79,5/76-79
85 (20+65) x80	1700+1707+1721+1715	81,5-84,5/76-79
90 (25+65) x80	1701+1707+1721+1715	86,5-89,5/76-79
90 (20+70) x80	1700+1708+1721+1715	86,5-89,5/76-79
90 (40+50) x80	1703+1706+1721+1715	86,5-89,5/76-79
95 (25+70) x80	1701+1708+1721+1715	91,5-94,5/76-79
95 (30+65) x80	1702+1707+1721+1715	91,5-94,5/76-79
100 (30+70) x80	1702+1708+1721+1715	96,5-99,5/76-79
100 (50+50) x80	1704+1706+1721+1715	96,5-99,5/76-79
100 (20+80) x80	1700+1709+1721+1715	96,5-99,5/76-79
105 (25+80) x80	1701+1709+1721+1715	101,5-104,5/76-79
105 (40+65) x80	1703+1707+1721+1715	101,5-104,5/76-79
110 (30+80) x80	1702+1709+1721+1715	106,5-109,5/76-79
110 (40+70) x80	1703+1708+1721+1715	106,5-109,5/76-79
110 (60+50) x80	1705+1706+1721+1715	106,5-109,5/76-79
115 (50+65) x80	1704+1707+1721+1715	111,5-114,5/76-79
120 (40+80) x80	1703+1709+1721+1715	116,5-119,5/76-79
120 (50+70) x80	1704+1708+1721+1715	116,5-119,5/76-79
125 (60+65) x80	1705+1707+1721+1715	121,5-124,5/76-79
130 (50+80) x80	1704+1709+1721+1715	126,5-129,5/76-79
130 (60+70) x80	1705+1708+1721+1715	126,5-129,5/76-79
140 (60+80) x80	1705+1709+1721+1715	136,5-139,5/76-79

COMBI C + LATERAL FIJO 90 c/BRAZO 1715

Medidas (F+A) xLF	Referencia	Rango
70 (20+50) x90	1700+1706+1722+1715	66,5-69,5/86-89
75 (25+50) x90	1701+1706+1722+1715	71,5-74,5/86-89
80 (30+50) x90	1702+1706+1722+1715	76,5-79,5/86-89
85 (20+65) x90	1700+1707+1722+1715	81,5-84,5/86-89
90 (25+65) x90	1701+1707+1722+1715	86,5-89,5/86-89
90 (20+70) x90	1700+1708+1722+1715	86,5-89,5/86-89
90 (40+50) x90	1703+1706+1722+1715	86,5-89,5/86-89
95 (25+70) x90	1701+1708+1722+1715	91,5-94,5/86-89
95 (30+65) x90	1702+1707+1722+1715	91,5-94,5/86-89
100 (30+70) x90	1702+1708+1722+1715	96,5-99,5/86-89
100 (50+50) x90	1704+1706+1722+1715	96,5-99,5/86-89
100 (20+80) x90	1700+1709+1722+1715	96,5-99,5/86-89
105 (25+80) x90	1701+1709+1722+1715	101,5-104,5/86-89
105 (40+65) x90	1703+1707+1722+1715	101,5-104,5/86-89
110 (30+80) x90	1702+1709+1722+1715	106,5-109,5/86-89
110 (40+70) x90	1703+1708+1722+1715	106,5-109,5/86-89
110 (60+50) x90	1705+1706+1722+1715	106,5-109,5/86-89
115 (50+65) x90	1704+1707+1722+1715	111,5-114,5/86-89
120 (40+80) x90	1703+1709+1722+1715	116,5-119,5/86-89
120 (50+70) x90	1704+1708+1722+1715	116,5-119,5/86-89
125 (60+65) x90	1705+1707+1722+1715	121,5-124,5/86-89
130 (50+80) x90	1704+1709+1722+1715	126,5-129,5/86-89
130 (60+70) x90	1705+1708+1722+1715	126,5-129,5/86-89
140 (60+80) x90	1705+1709+1722+1715	136,5-139,5/86-89

glass fijo + puerta abatible con cierre perfil imán

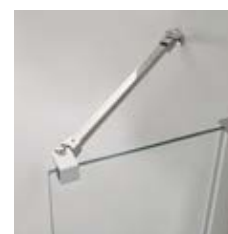

COMBI D

FIJOS	Ref.	Rango	PUERTAS	Ref.	Medida
FIJO 20	1700	17/20	PUERTA 30	1725+1212	33/35,5
FIJO 25	1701	22/25	PUERTA 35	1727+1212	38/40,5
FIJO 30	1702	27/30	PUERTA 40	1726+1212	43/45,5
FIJO 40	1703	37/40	PUERTA 45	1728+1212	48/50,5
FIJO 50	1704	47/50	PUERTA 50	1706+1212	53/55,5
FIJO 60	1705	57/60	PUERTA 65	1707+1212	68/70,5
		(3 cm ajuste)	PUERTA 70	1708+1212	73/75,5
Cierre perfil imán ref.1212			PUERTA 80	1709+1212	83/85,5

(2,5 cm ajuste)



Paneles fijos y puertas a medida ver pág. 258



COMBI D

Medidas	Fijo	Puerta	Apertura	Referencia	Rango
70	20	50	47	1700+1706+1212	70 - 75,5
75	25	50	47	1701+1706+1212	75 - 80,5
80	30	50	47	1702+1706+1212	80 - 85,5
85	20	65	62	1700+1707+1212	85 - 90,5
90	25	65	62	1701+1707+1212	90 - 95,5
90	20	70	67	1700+1708+1212	90 - 95,5
90	40	50	47	1703+1706+1212	90 - 95,5
95	25	70	67	1701+1708+1212	95 - 100,5
95	30	65	62	1702+1707+1212	95 - 100,5
100	30	70	67	1702+1708+1212	100 - 105,5
100	50	50	47	1704+1706+1212	100 - 105,5
100	20	80	77	1700+1709+1212	100 - 105,5
105	25	80	77	1701+1709+1212	105 - 110,5
105	40	65	62	1703+1707+1212	105 - 110,5
110	30	80	77	1702+1709+1212	110 - 115,5
110	40	70	67	1703+1708+1212	110 - 115,5
110	60	50	47	1705+1706+1212	110 - 115,5
115	50	65	62	1704+1707+1212	115 - 120,5
120	40	80	77	1703+1709+1212	120 - 125,5
120	50	70	67	1704+1708+1212	120 - 125,5
125	60	65	62	1705+1707+1212	125 - 130,5
130	50	80	77	1704+1709+1212	130 - 135,5
130	60	70	67	1705+1708+1212	130 - 135,5
140	60	80	77	1705+1709+1212	140 - 145,5

*Permite uso perfil compensación en ambos lados

*Permite combinación con lateral fijo STD, rango mínimo +0,7 / expansión 3 cm (ver pág. 201)

Referencias	Descripción
0218	perfil compensación +2 cm lado fijo
0029	perfil compensación +4 cm lado fijo
1221	imán expansión +1,2 cm (ver pág. 260)



Opción barra 140 cm Ref. 1716



glass fijo + 2 puertas abatibles + fijo



Opción barra 200 más soportes Ref. 1717

COMBI G

FIJOS	Ref.	Rango
FIJO 20	1700	17/20
FIJO 25	1701	22/25
FIJO 30	1702	27/30
FIJO 40	1703	37/40
FIJO 50	1704	47/50
FIJO 60	1705	57/60

(6 cm ajuste)

PUERTAS	Ref.	Medida
PUERTA 30	1725	30
PUERTA 35	1727	35
PUERTA 40	1726	40
PUERTA 45	1728	45
PUERTA 50	1706	50
PUERTA 65	1707	65
PUERTA 70	1708	70
PUERTA 80	1709	80

(sin ajuste)



Paneles fijos y puertas a medida ver pág. 258

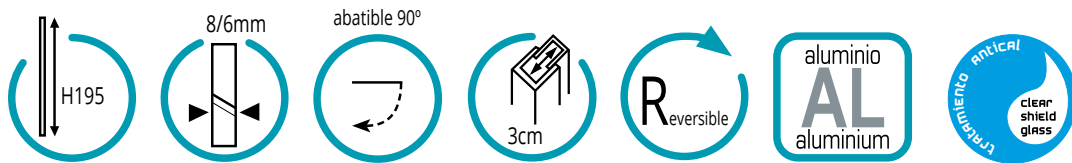

COMBI G

Combinación con puertas 50, 65, 70 y 80

Medidas (F+P+P+F)	Referencia	Rango
135(20+50+50+20)	1700+1706x2+1700	129,5/135,5
140(20+50+50+25)	1700+1706x2+1701	134,5/140,5
145(20+50+50+30)	1700+1706x2+1702	139,5/145,5
150(25+50+50+30)	1701+1706x2+1702	144,5/150,5
155(20+50+50+40)	1700+1706x2+1703	149,5/155,5
155(30+50+50+30)	1702+1706x2+1702	149,5/155,5
160(25+50+50+40)	1701+1706x2+1703	154,5/160,5
165(30+50+50+40)	1702+1706x2+1703	159,5/165,5
165(20+65+65+20)	1700+1707x2+1700	159,5/165,5
170(20+65+65+25)	1700+1707x2+1701	164,5/170,5
175(30+50+50+50)	1702+1706x2+1704	169,5/175,5
175(40+50+50+40)	1703+1706x2+1703	169,5/175,5
175(20+50+50+60)	1700+1706x2+1705	169,5/175,5
175(20+65+65+30)	1700+1707x2+1702	169,5/175,5
175(20+70+70+20)	1700+1708x2+1700	169,5/175,5
180(25+50+50+60)	1701+1706x2+1705	174,5/180,5
180(25+65+65+30)	1701+1707x2+1702	174,5/180,5
180(20+70+70+25)	1700+1708x2+1701	174,5/180,5
185(40+50+50+50)	1703+1706x2+1704	179,5/185,5
185(30+50+50+60)	1702+1706x2+1705	179,5/185,5
185(30+65+65+30)	1702+1707x2+1702	179,5/185,5
185(25+70+70+25)	1701+1708x2+1701	179,5/185,5
185(20+70+70+30)	1700+1708x2+1702	179,5/185,5
190(25+65+65+40)	1701+1707x2+1703	184,5/190,5
190(25+70+70+30)	1701+1708x2+1702	184,5/190,5
195(50+50+50+50)	1704+1706x2+1704	189,5/195,5
195(40+50+50+60)	1703+1706x2+1705	189,5/195,5
195(20+65+65+50)	1700+1707x2+1704	189,5/195,5
195(30+65+65+40)	1702+1707x2+1703	189,5/195,5
195(30+70+70+30)	1702+1708x2+1702	189,5/195,5
195(20+70+70+40)	1700+1708x2+1703	189,5/195,5

COMBI G

Combinación con puertas 50, 65, 70 y 80

Medidas (F+P+P+F)	Referencia	Rango
195(20+80+80+20)	1700+1709x2+1700	189,5/195,5
200(25+65+65+50)	1701+1707x2+1704	194,5/200,5
200(25+70+70+40)	1701+1708x2+1703	194,5/200,5
200(25+80+80+20)	1701+1709x2+1700	194,5/200,5
205(20+65+65+60)	1700+1707x2+1705	199,5/205,5
205(40+65+65+40)	1703+1707x2+1703	199,5/205,5
205(30+65+65+50)	1702+1707x2+1704	199,5/205,5
205(30+70+70+40)	1702+1708x2+1703	199,5/205,5
205(20+70+70+50)	1700+1708x2+1704	199,5/205,5
205(50+50+50+60)	1704+1706x2+1705	199,5/205,5
205(20+80+80+30)	1700+1709x2+1702	199,5/205,5
210(25+65+65+60)	1701+1707x2+1705	204,5/210,5
210(25+70+70+50)	1701+1708x2+1704	204,5/210,5
210(25+80+80+30)	1701+1709x2+1702	204,5/210,5
215(30+65+65+60)	1702+1707x2+1705	209,5/215,5
215(40+65+65+50)	1703+1707x2+1704	209,5/215,5
215(20+70+70+60)	1700+1708x2+1705	209,5/215,5
215(30+70+70+50)	1702+1708x2+1704	209,5/215,5
215(40+70+70+40)	1703+1708x2+1703	209,5/215,5
215(30+80+80+30)	1702+1709x2+1702	209,5/215,5
215(20+80+80+40)	1700+1709x2+1703	209,5/215,5
215(25+70+70+60)	1701+1708x2+1705	209,5/215,5
215(60+50+50+60)	1705+1706x2+1705	209,5/215,5
220(25+80+80+40)	1701+1709x2+1703	214,5/220,5
225(50+65+65+50)	1704+1707x2+1704	219,5/225,5
225(40+65+65+60)	1703+1707x2+1705	219,5/225,5
225(30+70+70+60)	1702+1708x2+1705	219,5/225,5
225(40+70+70+50)	1703+1708x2+1704	219,5/225,5
225(20+80+80+50)	1700+1709x2+1704	219,5/225,5

*Permite unión con lateral fijo STD en ambos lados (rango mínimo +0,7 cm / ajuste 3 cm), ver pág. 201

*Paneles fijos y puertas a medida (ver pág. 258)

Referencias	Descripción
0218	perfil compensación +2 cm
0029	perfil compensación +4 cm
1221	imán expansión +1,2 cm (ver pág. 260)

glass fijo + 2 puertas abatibles + fijo



COMBI G

FIJOS	Ref.	Rango
FIJO 20	1700	17/20
FIJO 25	1701	22/25
FIJO 30	1702	27/30
FIJO 40	1703	37/40
FIJO 50	1704	47/50
FIJO 60	1705	57/60

(6 cm ajuste)

PUERTAS	Ref.	Medida
PUERTA 30	1725	30
PUERTA 35	1727	35
PUERTA 40	1726	40
PUERTA 45	1728	45
PUERTA 50	1706	50
PUERTA 65	1707	65
PUERTA 70	1708	70
PUERTA 80	1709	80

(sin ajuste)



Paneles fijos y puertas a medida ver pág. 258

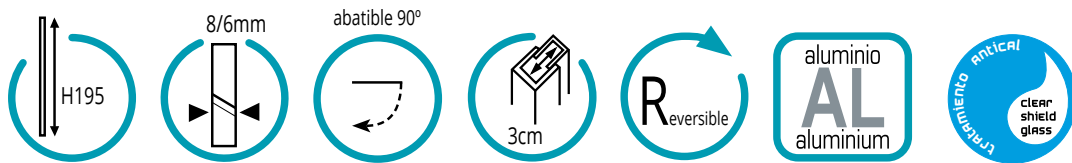

COMBI G

Medidas (F+P+P+F)	Referencia	Rango
225 (30+80+80+40)	1702+1709x2+1703	219,5/225,5
230 (25+80+80+50)	1701+1709x2+1704	224,5/230,5
235 (50+65+65+60)	1704+1707x2+1705	229,5/235,5
235 (40+70+70+60)	1703+1708x2+1705	229,5/235,5
235 (50+70+70+50)	1704+1708x2+1704	229,5/235,5
235 (20+80+80+60)	1700+1709x2+1705	229,5/235,5
235 (40+80+80+40)	1703+1709x2+1703	229,5/235,5
240 (25+80+80+60)	1701+1709x2+1705	234,5/240,5
245 (60+65+65+60)	1705+1707x2+1705	239,5/245,5
245 (50+70+70+60)	1704+1708x2+1705	239,5/245,5
245 (30+80+80+60)	1702+1709x2+1705	239,5/245,5
245 (40+80+80+50)	1703+1709x2+1704	239,5/245,5
255 (60+70+70+60)	1705+1708x2+1705	249,5/255,5
255 (40+80+80+60)	1703+1709x2+1705	249,5/255,5
255 (50+80+80+50)	1704+1709x2+1704	249,5/255,5
265 (50+80+80+60)	1704+1709x2+1705	259,5/265,5
275 (60+80+80+60)	1705+1709x2+1705	269,5/275,5

*Permite uso perfil compensación

*Permite unión con lateral fijo STD en ambos lados (rango mínimo +0,7 cm / ajuste 3 cm), ver pág. 201

*Paneles fijos y puertas a medida (ver pág. 258)

Referencias	Descripción
0218	perfil compensación +2 cm
0029	perfil compensación +4 cm
1221	imán expansión +1,2 cm (ver pág. 260)



Opción barra 200 más soportes Ref. 1717

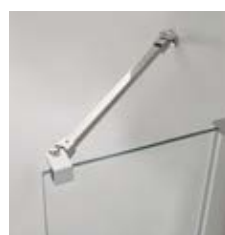

Brazo incluido



Bisagra en latón

glass angular 2 puertas abatibles + 2 fijos



COMBI H

FIJOS	Ref.	Rango
FIJO 20	1700	17/20
FIJO 25	1701	22/25
FIJO 30	1702	27/30
FIJO 40	1703	37/40
FIJO 50	1704	47/50
FIJO 60	1705	57/60

(3 cm ajuste)

PUERTAS	Ref.	Medida
PUERTA 30	1725	30
PUERTA 35	1727	35
PUERTA 40	1726	40
PUERTA 45	1728	45
PUERTA 50	1706	50
PUERTA 65	1707	65
PUERTA 70	1708	70
PUERTA 80	1709	80

(sin ajuste)



Paneles fijos y puertas a medida ver pág. 258

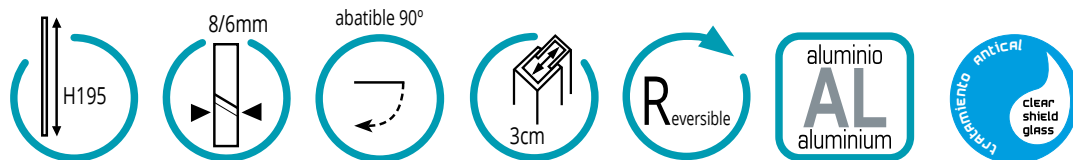

COMBI H

Combinación con puertas 50, 65, 70 y 80

Medidas (F+P+P+F)	Referencia	Rango
70x70(20+50+50+20)	1700+1706x2+1700	67-70/67-70
75X75(25+50+50+25)	1701+1706x2+1701	72-75/72-75
80X80(30+50+50+30)	1702+ 1706x2+1702	77-80/77-80
85x85(20+65+65+20)	1700+1707x2+1700	82-85/82-85
90x90(40+50+50+40)	1703+1706x2+1703	87-90/87-90
90x90(25+65+65+25)	1701+1707x2+1701	87-90/87-90
90x90(20+70+70+20)	1700+1708x2+1700	87-90/87-90
95x95(30+65+65+30)	1702+1707x2+1702	92-95/92-95
100x100(30+70+70+30)	1702+1708x2+1702	97-100/97-100
100x100(50+50+50+50)	1704+1706x2+1704	97-100/97-100
90x70(40+50+50+20)	1703+1706x2+1700	87-90 / 67-70
90x70(25+65+50+20)	1701+1707+1706+1700	87-90 / 67-70
90x70(20+70+50+20)	1700+1708+1706+1700	87-90 / 67-70
95x70(30+65+50+20)	1702+1707+1706+1700	92-95 / 67-70
95x70(25+70+50+20)	1701+1708+1706+1700	92-95 / 67-70
100x70(30+70+50+20)	1702+1708+1706+1700	97-100 / 67-70
100x70(20+80+50+20)	1700+1709+1706+1700	97-100 / 67-70
105x70(40+65+50+20)	1703+1707+1706+1700	102-105 / 67-70
105x70(25+80+50+20)	1701+1709+1706+1700	102-105 / 67-70
110x70(40+70+50+20)	1703+1708+1706+1700	107-110 / 67-70
110x70(30+80+50+20)	1702+1709+1706+1700	107-110 / 67-70
110x70(60+50+50+20)	1705+1706+1706+1700	107-110/ 67-70
115x70(50+65+50+20)	1704+1707+1706+1700	112-115/ 67-70
120x70(50+70+50+20)	1704+1708+1706+1700	117-120 / 67-70
120x70(40+80+50+20)	1703+1709+1706+1700	117-120 / 67-70
125x70(60+65+50+20)	1705+1707+1706+1700	122-125 / 67-70
130x70(50+80+50+20)	1704+1709+1706+1700	127-130 / 67-70
130x70(60+70+50+20)	1705+1708+1706+1700	127-130 / 67-70
140x70(60+80+50+20)	1705+1709+1706+1700	137-140 / 67-70
90x80(40+50+50+30)	1703+1706x2+1702	87-90 / 77-80
90x80(25+65+50+30)	1701+1707+1706+1702	87-90 / 77-80

*Permite uso perfil compensación en ambos lados

*Paneles fijos y puertas a medida (ver pág. 258)

Referencias	Descripción
0218	perfil compensación +2 cm
0029	perfil compensación +4 cm

COMBI H

Combinación con puertas 50, 65, 70 y 80

Medidas (F+P+P+F)	Referencia	Rango
90x80(20+70+50+30)	1700+1708+1706+1702	87-90 / 77-80
95x80(30+65+50+30)	1702+1707+1706+1702	92-95 / 77-80
95x80(25+70+50+30)	1701+1708+1706+1702	92-95 / 77-80
100x80(30+70+50+30)	1702+1708+1706+1702	97-100 / 77-80
100x80(20+80+50+30)	1700+1709+1706+1702	97-100 / 77-80
105x80(40+65+50+30)	1703+1707+1706+1702	102-105 / 77-80
105x80(25+80+50+30)	1701+1709+1706+1702	102-105 / 77-80
110x80(60+50+50+30)	1705+1706+1706+1702	107-110 / 77-80
110x80(40+70+50+30)	1703+1708+1706+1702	107-110 / 77-80
110x80(30+80+50+30)	1702+1709+1706+1702	107-110 / 77-80
115x80(50+65+50+30)	1704+1707+1706+1702	112-115 / 77-80
120x80(50+70+50+30)	1704+1708+1706+1702	117-120 / 77-80
120x80(40+80+50+30)	1703+1709+1706+1702	117-120 / 77-80
125x80(60+65+50+30)	1705+1707+1706+1702	122-125 / 77-80
130x80(50+80+50+30)	1704+1709+1706+1702	127-130 / 77-80
130x80(60+70+50+30)	1705+1708+1706+1702	127-130 / 77-80
140x80(60+80+50+30)	1705+1709+1706+1702	137-140 / 77-80
95x90(30+65+50+40)	1702+1707+1706+1703	92-95 / 87-90
95x90(25+70+50+40)	1701+1708+1706+1703	92-95 / 87-90
95x90(30+65+65+25)	1702+1707x2+1701	92-95 / 87-90
95x90(25+70+65+25)	1701+1708+1707+1701	92-95 / 87-90
95x90(30+65+70+20)	1702+1707+1708+1700	92-95 / 87-90
95x90(25+70+70+20)	1701+1708x2+1700	92-95 / 87-90
100x90(30+70+50+40)	1702+1708+1706+1703	97-100 / 87-90
100x90(20+80+50+40)	1700+1709+1706+1703	97-100 / 87-90
100x90(30+70+65+25)	1702+1708+1707+1701	97-100 / 87-90
100x90(20+80+65+25)	1700+1709+1707+1701	97-100 / 87-90
100x90(30+70+70+20)	1702+1708x2+1700	97-100 / 87-90
100x90(20+80+70+20)	1700+1709+1708+1700	97-100 / 87-90
105x90(40+65+50+40)	1703+1707+1706+1703	102-105 / 87-90
105x90(25+80+50+40)	1701+1709+1706+1703	102-105 / 87-90

glass angular 2 puertas abatibles + 2 fijos

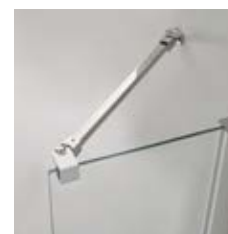

COMBI H

FIJOS	Ref.	Rango
FIJO 20	1700	17/20
FIJO 25	1701	22/25
FIJO 30	1702	27/30
FIJO 40	1703	37/40
FIJO 50	1704	47/50
FIJO 60	1705	57/60

(3 cm ajuste)

PUERTAS	Ref.	Medida
PUERTA 30	1725	30
PUERTA 35	1727	35
PUERTA 40	1726	40
PUERTA 45	1728	45
PUERTA 50	1706	50
PUERTA 65	1707	65
PUERTA 70	1708	70
PUERTA 80	1709	80

(sin ajuste)



Paneles fijos y puertas a medida ver pág. 258



COMBI H

Combinación con puertas 50, 65, 70 y 80

Medidas (F+P+P+F)	Referencia	Rango
105x90(40+65+65+25)	1703+1707x2+1701	102-105 / 87-90
105x90(25+80+65+25)	1701+1709+1707+1701	102-105 / 87-90
105x90(40+65+70+20)	1703+1707+1708+1700	102-105 / 87-90
105x90(25+80+70+20)	1701+1709+1708+1700	102-105 / 87-90
110x90(60+50+50+40)	1705+1706x2+1703	107-110 / 87-90
110x90(40+70+50+40)	1703+1708+1706+1703	107-110 / 87-90
110x90(30+80+50+40)	1702+1709+1706+1703	107-110 / 87-90
110x90(60+50+65+25)	1705+1706+1707+1701	107-110 / 87-90
110x90(40+70+65+25)	1703+1708+1707+1701	107-110 / 87-90
110x90(30+80+65+25)	1702+1709+1707+1701	107-110 / 87-90
110x90(60+50+70+20)	1705+1706+1708+1700	107-110 / 87-90
110x90(40+70+70+20)	1703+1708x2+1700	107-110 / 87-90
110x90(30+80+70+20)	1702+1709+1708+1700	107-110 / 87-90
115x90(50+65+50+40)	1704+1707+1706+1703	112-115 / 87-90
115x90(50+65+65+25)	1704+1707x2+1701	112-115 / 87-90
115x90(50+65+70+20)	1704+1707+1708+1700	112-115 / 87-90
120x90(50+70+50+40)	1704+1708+1706+1703	117-120 / 87-90
120x90(40+80+50+40)	1703+1709+1706+1703	117-120 / 87-90

COMBI H

Combinación con puertas 50, 65, 70 y 80

Medidas (F+P+P+F)	Referencia	Rango
120x90(50+70+65+25)	1704+1708+1707+1701	117-120 / 87-90
120x90(40+80+65+25)	1703+1709+1707+1701	117-120 / 87-90
120x90(50+70+70+20)	1704+1708x2+1700	117-120 / 87-90
120x90(40+80+70+20)	1703+1709+1708+1700	117-120 / 87-90
125x90(60+65+50+40)	1705+1707+1706+1703	122-125 / 87-90
125x90(60+65+65+25)	1705+1707x2+1701	122-125 / 87-90
125x90(60+65+70+20)	1705+1707+1708+1700	122-125 / 87-90
130x90(60+70+50+40)	1705+1708+1706+1703	127-130 / 87-90
130x90(50+80+50+40)	1704+1709+1706+1703	127-130 / 87-90
130x90(50+80+65+25)	1704+1709+1707+1701	127-130 / 87-90
130x90(60+70+70+20)	1705+1708x2+1700	127-130 / 87-90
130x90(50+80+70+20)	1704+1709+1708+1700	127-130 / 87-90
140x90(60+80+50+40)	1705+1709+1706+1703	137-140 / 87-90
140x90(60+80+65+25)	1705+1709+1707+1701	137-140 / 87-90
140x90(60+80+70+20)	1705+1709+1708+1700	137-140 / 87-90

*Permite uso perfil compensación en ambos lados

*Paneles fijos y puertas a medida (ver pág. 258)

Referencias	Descripción
0218	perfil compensación +2 cm
0029	perfil compensación +4 cm



Opción barras + soportes Ref. 1716x2+1730

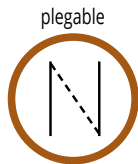
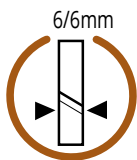
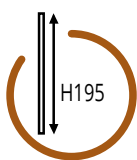

glass plegable COMBI 1 con cierre imán a pared



plegadas al exterior del plato

Medidas	Rango	Referencias
50 (20+30)	47,5/49	1710+1725
55 (25+30)	52,5/54	1711+1725
60 (20+40)	57,5/59	1710+1726
65 (25+40)	62,5/64	1711+1726
70 (20+50)	67,5/69	1710+1706
70 (30+40)	67,5/69	1712+1726
75 (25+50)	72,5/74	1711+1706
80 (30+50)	77,5/79	1712+1706
85 (20+65)	82,5/84	1710+1707
90 (20+70)	87,5/89	1710+1708
90 (25+65)	87,5/89	1711+1707
90 (40+50)	87,5/89	1713+1706
95 (25+70)	92,5/94	1711+1708
95 (30+65)	92,5/94	1712+1707
100 (30+70)	97,5/99	1712+1708

Permite combinación con lateral fijo Glass en lado puerta, el rango del frontal se reducirá en 0,5 cm

plegadas al interior del plato

Medidas	Rango	Referencias
60 (30+30)	57,5/59	1712+1725
70 (40+30)	67,5/69	1713+1725
75 (40+35)	72,5/74	1713+1727
80 (40+40)	77,5/79	1713+1726
80 (50+30)	77,5/79	1714+1725
85 (50+35)	82,5/84	1714+1727
90 (50+40)	87,5/89	1714+1726
95 (50+45)	92,5/94	1714+1728
100 (50+50)	97,5/99	1714+1706

Permite combinación con lateral fijo Glass en lado puerta, el rango del frontal se reducirá en 0,5 cm

Ref.	Descripción
1215	perfil puerta (reduce hasta 1 cm el rango)
1222	perfil expansión +2,5 cm
1221	imanes de expansión +1,2 cm



Opción puertas a medida (ver pág. 258)

Ref.	Descripción
1338	Puerta < 80 cm

glass plegable al interior de plato + lat. fijo

COMBI 1 + LATERAL FIJO 70 c/BRAZO 1715

Medidas	Rango	Referencias
60 (30+30)x70	57-58,5/66-69	1712+1725+1720F+1715
70 (40+30)x70	67-68,5/66-69	1713+1725+1720F+1715
75 (40+35)x70	72-73,5/66-69	1713+1727+1720F+1715
80 (40+40)x70	77-78,5/66-69	1713+1726+1720F+1715
80 (50+30)x70	77-78,5/66-69	1714+1725+1720F+1715
85 (50+35)x70	82-83,5/66-69	1714+1727+1720F+1715
90 (50+40)x70	87-88,5/66-69	1714+1726+1720F+1715
95 (50+45)x70	92-93,5/66-69	1714+1728+1720F+1715
100 (50+50)x70	97-98,5/66-69	1714+1706+1720F+1715



COMBI 1 + LATERAL FIJO 80 c/BRAZO 1715

Medidas	Rango	Referencias
60 (30+30)x80	57-58,5/76-79	1712+1725+1721F+1715
70 (40+30)x80	67-68,5/76-79	1713+1725+1721F+1715
75 (40+35)x80	72-73,5/76-79	1713+1727+1721F+1715
80 (40+40)x80	77-78,5/76-79	1713+1726+1721F+1715
80 (50+30)x80	77-78,5/76-79	1714+1725+1721F+1715
85 (50+35)x80	82-83,5/76-79	1714+1727+1721F+1715
90 (50+40)x80	87-88,5/76-79	1714+1726+1721F+1715
95 (50+45)x80	92-93,5/76-79	1714+1728+1721F+1715
100 (50+50)x80	97-98,5/76-79	1714+1706+1721F+1715

COMBI 1 + LATERAL FIJO 90 c/BRAZO 1715

Medidas	Rango	Referencias
60 (30+30)x90	57-58,5/86-89	1712+1725+1722F+1715
70 (40+30)x90	67-68,5/86-89	1713+1725+1722F+1715
75 (40+35)x90	72-73,5/86-89	1713+1727+1722F+1715
80 (40+40)x90	77-78,5/86-89	1713+1726+1722F+1715
80 (50+30)x90	77-78,5/86-89	1714+1725+1722F+1715
85 (50+35)x90	82-83,5/86-89	1714+1727+1722F+1715
90 (50+40)x90	87-88,5/86-89	1714+1726+1722F+1715
95 (50+45)x90	92-93,5/86-89	1714+1728+1722F+1715
100 (50+50)x90	97-98,5/86-89	1714+1706+1722F+1715

laterales fijos GLASS PLEGABLE 6 mm

Referencias	Descripción	Rango
1720F	lateral fijo 70	66 - 69
1721F	lateral fijo 80	76 - 79
1722F	lateral fijo 90	86 - 89

Referencias	Descripción
0218	perfil compensación +2 cm
0029	perfil compensación +4 cm
0219	perfil compensación +5,5 cm

Opciones brazos

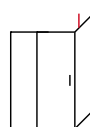

brazo 45° 1715

32

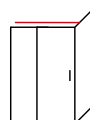

brazo recto 0166 hasta 99 cm

37

brazo recto 0181 hasta 120 cm

50

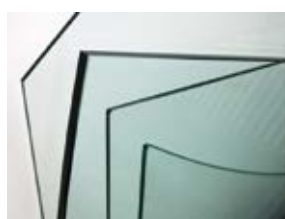

Laterales fijos a medida 6 mm (más información en página 259)

Referencias	Descripción
1345	lateral fijo a medida OPEN hasta 40 cm
1316	lateral fijo a medida OPEN de 40 hasta 80 cm
1317	lateral fijo a medida OPEN de 80 hasta 120 cm

*Plazo de entrega 15 días

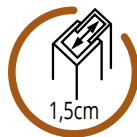
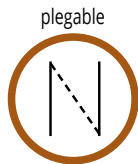
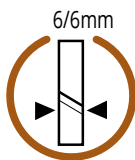
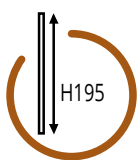

glass plegable COMBI 2 con cierre perfil imán



plegadas al exterior del plato

Medida	Rango	Referencias
55 (20+30)	50/54	1710+1725+1212
60 (25+30)	55/59	1711+1725+1212
65 (20+40)	60/64	1710+1726+1212
70 (25+40)	65/69	1711+1726+1212
75 (20+50)	70/74	1710+1706+1212
75 (30+40)	70/74	1712+1726+1212
80 (25+50)	75/79	1711+1706+1212
85 (30+50)	80/84	1712+1706+1212
90 (20+65)	85/89	1710+1707+1212
95 (20+70)	90/94	1710+1708+1212
95 (25+65)	90/94	1711+1707+1212
95 (40+50)	90/94	1713+1706+1212
100 (25+70)	95/99	1711+1708+1212
100 (30+65)	95/99	1712+1707+1212
105 (30+70)	100/104	1712+1708+1212

Permite combinación con lateral fijo STD en lado puerta, el rango mínimo el frontal aumenta 0,7 cm

plegadas al interior del plato

Medida	Rango	Referencias
65 (30+30)	60/64	1712+1725+1212
75 (40+30)	70/74	1713+1725+1212
80 (40+35)	75/79	1713+1727+1212
85 (40+40)	80/84	1713+1726+1212
85 (50+30)	80/84	1714+1725+1212
90 (50+35)	85/89	1714+1727+1212
95 (50+40)	90/94	1714+1726+1212
100 (50+45)	95/99	1714+1728+1212
105 (50+50)	100/104	1714+1706+1212

Permite combinación con lateral fijo STD en lado puerta, el rango mínimo el frontal aumenta 0,7 cm

Ref.	Descripción
1215	perfil puerta (reduce hasta 1 cm el rango)
1222	perfil expansión lado cristal +2,5 cm
1221	imanes de expansión +1,2 cm
0218	perfil exp. lado cierre perfil imán (+3 cm)
0029	perfil exp. lado cierre perfil imán (+6 cm)

glass/glass plegable

combinaciones con lateral fijo STD:

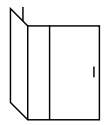
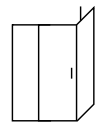
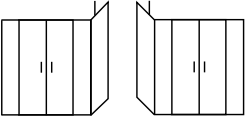
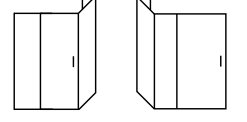
Disponible para combinaciones GLASS	GLASS PLEGABLE
COMBI C lado fijo 	COMBI 2 lado puerta 
COMBI G ambos lados 	
COMBI D ambos lados 	

a lado fijo

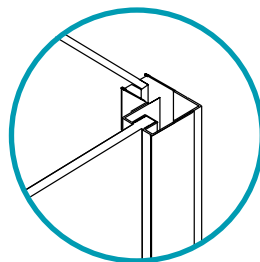

a puerta con cierre perfil imán

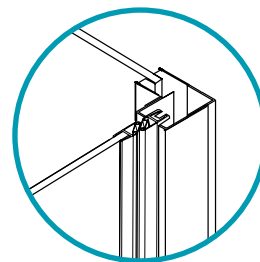

*Si la unión es al lado fijo o del cierre perfil imán ref. 1212, se suman +0,7 cm al rango mín. de la combinación + expansión del lado libre de lateral fijo. La expansión del lado fijo se pierde.



ABATIBLES

laterales fijos STD TRANSPARENTES 8 mm

Referencias	Descripción	Rango
0810+1715	lateral fijo STD 30x195 + brazo	26 - 29
0811+1715	lateral fijo STD 40x195 + brazo	36 - 39
0812+1715	lateral fijo STD 50x195 + brazo	46 - 49
0813+1715	lateral fijo STD 60x195 + brazo	56 - 59
0814+1715	lateral fijo STD 70x195 + brazo	66 - 69
0820+1715	lateral fijo STD 75x195 + brazo	71 - 74
0815+1715	lateral fijo STD 80x195 + brazo	76 - 79
0816+1715	lateral fijo STD 90x195 + brazo	86 - 89



Referencias	Descripción
0218	perfil compensación +2 cm
0029	perfil compensación +4 cm
0219	perfil compensación +5,5 cm



Laterales fijos a medida STD 8 mm (más información en página 259)

Referencias	Descripción
1343+1715	lateral fijo a medida STD hasta 40 cm
1304+1715	lateral fijo a medida STD de 40 hasta 80 cm
1310+1715	lateral fijo a medida STD de 80 hasta 120 cm

*Plazo de entrega 15 días

GME

BASIC COLOR
pg.204



TWENTY BLACK
pg.216



OPEN BLACK
pg.220



SCREEN CHESS
pg.242

SCREEN BLACK
pg.244

SCREEN WHITE
pg.246



COLOR ● ○ ●

**MAMPARAS
COLOR**

basic color

FRONTAL PERFILERÍA NEGRA



Doble rodamiento regulable en nylon con antivuelco



Nuevo guiador optimizado con pulsador liberador de hoja



Opción tirador extraplano negro
22x1,6x0,7 cm

Ref.

9031

FRONTAL PERFILERÍA BLANCA/CROMO



FRONTAL PERFILERÍA BLANCA



FRONTAL PERFILERÍA TITANIO





PASO 1: Seleccionar medida/color de la PERFILERÍA

PASO 2: Seleccionar medida/decorado de los FRONTALES



PASO 1: PERFILERÍA

Descripción	NEGRO	BLANCO/CROMO	BLANCO	TITANIO
	Ref.	Ref.	Ref.	Ref.
Accesorios frontal hasta 140 cm	5493	5483	5583	5560
Accesorios de 140 cm hasta 180 cm	5494	5484	5584	5561
Accesorios de 180 cm hasta 200 cm	5495	5485	5585	5562

PASO 2: FRONTALES

Medida	Rangos (cm)	TRANSPARENTE	FROST PLUS
		Ref.	Ref.
100	Cristales de 95-100	5001	6001
105	Cristales de 100-105	5002	6002
110	Cristales de 105-110	5003	6003
115	Cristales de 110-115	5004	6004
120	Cristales de 115-120	5005	6005
125	Cristales de 120-125	5006	6006
130	Cristales de 125-130	5007	6007
135	Cristales de 130-135	5008	6008
140	Cristales de 135-140	5009	6009
145	Cristales de 140-145	5010	6010
150	Cristales de 145-150	5011	6011
155	Cristales de 150-155	5012	6012
160	Cristales de 155-160	5013	6013
165	Cristales de 160-165	5014	6014
170	Cristales de 165-170	5015	6015
175	Cristales de 170-175	5016	6016
180	Cristales de 175-180	5017	6017
190	Cristales de 180-190	5023	6023
200	Cristales de 190-200	5024	6024

Accesorios

Descripción	NEGRO	BLANCO	TITANIO
	Ref.	Ref.	Ref.
Perfil de compensación +1,5 cm	5477	5473	5478
Pletina embellecedora 195x3,8 cm	0007N	0007B	0007T

basic free color

PERFILERÍA TITANIO



Perfilería con stopper antivuelco



Doble rodamiento regulable en nylon con antivuelco



Nuevo guiador optimizado con pulsador liberador de hoja

PERFILERÍA BLANCA/CROMO



PERFILERÍA BLANCA



PERFILERÍA NEGRA



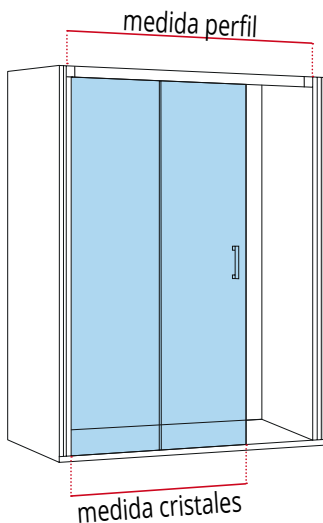

PASO 1: Seleccionar medida/color de la PERFILERÍA
PASO 2: Seleccionar medida/decorado de los FRONTALES



PASO 1: PERFILERÍA

Descripción
Perf. y acc. hasta 140 + KIT FREE
Perf. y acc. hasta 180 + KIT FREE
Perf. y acc. hasta 200 + KIT FREE

NEGRO	BLANCO/CROMO	BLANCO	TITANIO
Ref.	Ref.	Ref.	Ref.
5493+5447N	5483+5447B	5583+5447B	5560+5447T
5494+5447N	5484+5447B	5584+5447B	5561+5447T
5495+5447N	5485+5447B	5585+5447B	5562+5447T

PASO 2: CRISTALES

Rangos (cm)
Cristales de 95-100
Cristales de 100-105
Cristales de 105-110
Cristales de 110-115
Cristales de 115-120
Cristales de 120-125
Cristales de 125-130
Cristales de 130-135
Cristales de 135-140
Cristales de 140-145
Cristales de 145-150
Cristales de 150-155
Cristales de 155-160
Cristales de 160-165
Cristales de 165-170
Cristales de 170-175
Cristales de 175-180
Cristales de 180-190
Cristales de 190-200

TRANSPARENTE	FROST PLUS
Ref.	Ref.
5001	6001
5002	6002
5003	6003
5004	6004
5005	6005
5006	6006
5007	6007
5008	6008
5009	6009
5010	6010
5011	6011
5012	6012
5013	6013
5014	6014
5015	6015
5016	6016
5017	6017
5023	6023
5024	6024

basic fijo + puerta + fijo

NOVEDAD

PERFILERÍA NEGRA



Perfilería con stopper antivuelco



Doble rodamiento regulable en nylon con antivuelco



Nuevo guiador optimizado con pulsador liberador de hoja

PERFILERÍA BLANCA/CROMO



PERFILERÍA BLANCA



PERFILERÍA TITANIO



PASO 1: Seleccionar medida/color de la PERFILERÍA

PASO 2: Seleccionar medida/decorado FIJO EN LÍNEA

PASO 3: Seleccionar medida/decorado de los FRONTALES

Rango = Rango Min/Max frontal + Medida fijo en línea



PASO 1: PERFILERÍA

Descripción	NEGRO	BLANCO/CROMO	BLANCO	TITANIO
	Ref.	Ref.	Ref.	Ref.
Accesorios frontal hasta 140 cm	5493+5467N	5483+5467B	5583+5467B	5560+5467T
Accesorios frontal hasta 180 cm	5494+5467N	5484+5467B	5584+5467B	5561+5467T
Accesorios frontal hasta 200 cm	5495+5467N	5485+5467B	5585+5467B	5562+5467T

PASO 2: FIJOS EN LÍNEA

Medida fijo	TRANSPARENTE	FROST PLUS
	Ref.	Ref.
Fijo de 30 cm	5018F	6018F
Fijo de 35 cm	5019F	6019F
Fijo de 40 cm	5020F	6020F
Fijo de 45 cm	5021F	6021F
Fijo de 52 cm	5002F	6002F
Fijo de 55 cm	5022F	6022F
Fijo de 57 cm	5004F	6004F

PASO 3: FRONTALES

Descripción	Rangos (cm)	TRANSPARENTE	FROST PLUS
		Ref.	Ref.
Fijo + Puerta frontal de 100	95-100	5001	6001
Fijo + Puerta frontal de 105	100-105	5002	6002
Fijo + Puerta frontal de 110	105-110	5003	6003
Fijo + Puerta frontal de 115	110-115	5004	6004
Fijo + Puerta frontal de 120	115-120	5005	6005
Fijo + Puerta frontal de 125	120-125	5006	6006
Fijo + Puerta frontal de 130	125-130	5007	6007
Fijo + Puerta frontal de 135	130-135	5008	6008
Fijo + Puerta frontal de 140	135-140	5009	6009
Fijo + Puerta frontal de 145	140-145	5010	6010
Fijo + Puerta frontal de 150	145-150	5011	6011
Fijo + Puerta frontal de 155	150-155	5012	6012
Fijo + Puerta frontal de 160	155-160	5013	6013
Fijo + Puerta frontal de 165	160-165	5014	6014
Fijo + Puerta frontal de 170	165-170	5015	6015
Fijo + Puerta frontal de 175	170-175	5016	6016
Fijo + Puerta frontal de 180	175-180	5017	6017
Fijo + Puerta frontal de 190	180-190	5023	6023
Fijo + Puerta frontal de 200	190-200	5024	6024

COLOR ● ○

basic spazio color

PERFILERÍA TITANIO



Perfilería con stopper antivuelco



Doble rodamiento regulable en nylon con antivuelco



Nuevo guiador optimizado con pulsador liberador de hoja

FRONTAL PERFILERÍA BLANCA/CROMO



FRONTAL PERFILERÍA BLANCA



FRONTAL PERFILERÍA NEGRA





PASO 1: Seleccionar medida/color de la PERFILERÍA
PASO 2: Seleccionar medida/decorado de los FRONTALES



PASO 1: PERFILERÍA

Descripción	NEGRO	BLANCO/CROMO	BLANCO	TITANIO
	Ref.	Ref.	Ref.	Ref.
Accesorios frontal hasta 172 cm	5496	5486	5586	5565
Accesorios de 172 cm hasta 210 cm	5497	5487	5587	5566

PASO 2: FRONTALES

Medida	Rangos	TRANSPARENTE	FROST PLUS
		Ref.	Ref.
Cristales de 140	132-142	5029+5029	6029+6029
Cristales de 150	142-152	5019+5019	6019+6019
Cristales de 160	152-162	5030+5030	6030+6030
Cristales de 170	162-172	5020+5020	6020+6020
Cristales de 180	172-182	5031+5031	6031+6031
Cristales de 190	182-192	5021+5021	6021+6021
Cristales de 200	190-200	5001+5001	6001+6001
Cristales de 210	200-210	5002+5002	6002+6002

Accesorios

Descripción	NEGRO	BLANCO	TITANIO
	Ref.	Ref.	Ref.
Perfil de compensación +1,5 cm	5477	5473	5478
Pletina embellecedora 195x3,8 cm	0007N	0007B	0007T

COLOR ● ○ ●

basic color al vértice

PERFILERÍA NEGRO



Perfilería con stopper antivuelco



Doble rodamiento regulable en nylon con antivuelco



Nuevo guiador optimizado con pulsador liberador de hoja

FRONTAL PERFILERÍA BLANCA/CROMO



FRONTAL PERFILERÍA BLANCA



FRONTAL PERFILERÍA TITANIO



PASO 1: Seleccionar medida/color de la PERFILERÍA
PASO 2: Seleccionar medida/decorado de los FRONTALES



PASO 1: PERFILERÍA

Descripción
Accesorios hasta 120x90 cm
Accesorios hasta 140x100 cm

NEGRO	BLANCO/CROMO	BLANCO	TITANIO
Ref.	Ref.	Ref.	Ref.
5490	5480	5580	5563
5491	5481	5581	5564

PASO 2: FRONTALES+LADOS

Medida	Rangos (cm)	TRANSPARENTE	FROST PLUS
		Ref.	Ref.
combinaciones c/ LADOS 70 fijo+corredera			
70x70	Cristales de 65-70/65-70	5018+5018	6018+6018
75x70	Cristales de 70-75/65-70	5029+5018	6029+6018
80x70	Cristales de 75-80/65-70	5019+5018	6019+6018
90x70	Cristales de 85-90/65-70	5020+5018	6020+6018
100x70	Cristales de 95-100/65-70	5021+5018	6021+6018
110x70	Cristales de 105-109/65-70	5002+5018	6002+6018
120x70	Cristales de 115-120/65-70	5022+5018	6022+6018
130x70	Cristales de 125-129/65-70	5006+5018	6006+6018
140x70	Cristales de 135-139/65-70	5008+5018	6008+6018
combinaciones c/ LADOS 75 fijo+corredera			
75x75	Cristales de 70-75/70-75	5029+5029	6029+6029
80x75	Cristales de 75-80/70-75	5019+5029	6019+6029
90x75	Cristales de 85-90/70-75	5020+5029	6020+6029
100x75	Cristales de 95-100/70-75	5021+5029	6021+6029
110x75	Cristales de 105-109/70-75	5002+5029	6002+6029
120x75	Cristales de 115-120/70-75	5022+5029	6022+6029
130x75	Cristales de 125-129/70-75	5006+5029	6006+6029
140x75	Cristales de 135-139/70-75	5008+5029	6008+6029
combinaciones c/ LADOS 80 fijo+corredera			
80x80	Cristales de 75-80/75-80	5019+5019	6019+6019
90x80	Cristales de 85-90/75-80	5020+5019	6020+6019
100x80	Cristales de 95-100/75-80	5021+5019	6021+6019
110x80	Cristales de 105-109/75-80	5002+5019	6002+6019
120x80	Cristales de 115-120/75-80	5022+5019	6022+6019
130x80	Cristales de 125-129/75-80	5006+5019	6006+6019
140x80	Cristales de 135-139/75-80	5008+5019	6008+6019
combinaciones c/ LADOS 90 fijo+corredera			
90x90	Cristales de 85-90/85-90	5020+5020	6020+6020
100x90	Cristales de 95-100/85-90	5021+5020	6021+6020
110x90	Cristales de 105-109/85-90	5002+5020	6002+6020
120x90	Cristales de 115-120/85-90	5022+5020	6022+6020
130x90	Cristales de 125-129/85-90	5006+5020	6006+6020
140x90	Cristales de 135-139/85-90	5008+5020	6008+6020

COLOR ● ○ ●

basic color con lateral fijo

PERFILERÍA TITANIO



FRONTAL PERFILERÍA BL/CR



FRONTAL PERFILERÍA BLANCA



FRONTAL PERFILERÍA TITANIO



PASO 1: Seleccionar medida/color de la PERFILERÍA
PASO 2: Seleccionar medida/decorado de los FRONTALES



PASO 1: PERFILERÍA

Descripción

Accesorios hasta 140 cm

Accesorios hasta 180 cm

	NEGRO	BLANCO/CROMO	BLANCO	TITANIO
	Ref.	Ref.	Ref.	Ref.
	5493+5492	5483+5482	5583+5588	5560+5567
	5494+5492	5484+5482	5584+5588	5561+5567

PASO 2: FRONTALES+LAT. FIJO

		TRANSPARENTE	FROST PLUS
Medida	Rangos (cm)	Ref.	Ref.
combinaciones c/ LATERAL FIJO DE 70			
100x70	Cristales de 95-100/67-69	5001+5025	6001+6025
110x70	Cristales de 105-110/67-69	5003+5025	6003+6025
120x70	Cristales de 115-120/67-69	5005+5025	6005+6025
130x70	Cristales de 125-130/67-69	5007+5025	6007+6025
140x70	Cristales de 135-140/67-69	5009+5025	6009+6025
150x70	Cristales de 145-150/67-69	5011+5025	6011+6025
160x70	Cristales de 155-160/67-69	5013+5025	6013+6025
170x70	Cristales de 165-170/67-69	5015+5025	6015+6025
180x70	Cristales de 175-180/67-69	5017+5025	6017+6025
combinaciones c/ LATERAL FIJO DE 75			
100x75	Cristales de 95-100/72-74	5001+5057	6001+6057
110x75	Cristales de 105-110/72-74	5003+5057	6003+6057
120x75	Cristales de 115-120/72-74	5005+5057	6005+6057
130x75	Cristales de 125-130/72-74	5007+5057	6007+6057
140x75	Cristales de 135-140/72-74	5009+5057	6009+6057
150x75	Cristales de 145-150/72-74	5011+5057	6011+6057
160x75	Cristales de 155-160/72-74	5013+5057	6013+6057
170x75	Cristales de 165-170/72-74	5015+5057	6015+6057
180x75	Cristales de 175-180/72-74	5017+5057	6017+6057
combinaciones c/ LATERAL FIJO DE 80			
100x80	Cristales de 95-100/77-79	5001+5026	6001+6026
110x80	Cristales de 105-110/77-79	5003+5026	6003+6026
120x80	Cristales de 115-120/77-79	5005+5026	6005+6026
130x80	Cristales de 125-130/77-79	5007+5026	6007+6026
140x80	Cristales de 135-140/77-79	5009+5026	6009+6026
150x80	Cristales de 145-150/77-79	5011+5026	6011+6026
160x80	Cristales de 155-160/77-79	5013+5026	6013+6026
170x80	Cristales de 165-170/77-79	5015+5026	6015+6026
180x80	Cristales de 175-180/77-79	5017+5026	6017+6026
combinaciones c/ LATERAL FIJO DE 90			
100x90	Cristales de 95-100/87-89	5001+5027	6001+6027
110x90	Cristales de 105-110/87-89	5003+5027	6003+6027
120x90	Cristales de 115-120/87-89	5005+5027	6005+6027
130x90	Cristales de 125-130/87-89	5007+5027	6007+6027
140x90	Cristales de 135-140/87-89	5009+5027	6009+6027
150x90	Cristales de 145-150/87-89	5011+5027	6011+6027
160x90	Cristales de 155-160/87-89	5013+5027	6013+6027
170x90	Cristales de 165-170/87-89	5015+5027	6015+6027
180x90	Cristales de 175-180/87-89	5017+5027	6017+6027

twenty black 1 fijo+1 corredera

NOVEDAD



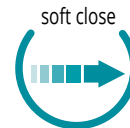
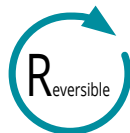
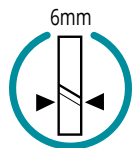
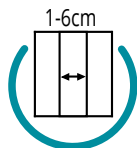
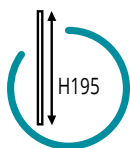

frontales TWENTY BLACK 1 fijo + 1 corredera

Medida	Apertura	Ref.
115-120	46 - 51	2000+2023
120-125	49 - 54	2001+2023
125-130	51 - 56	2002+2023
130-135	54 - 59	2003+2023
135-140	56 - 61	2004+2023
140-145	59 - 64	2005+2023
145-150	61 - 66	2006+2023
150-155	64 - 69	2007+2024
155-160	66 - 71	2008+2024
160-165	69 - 74	2009+2024
165-170	71 - 76	2010+2024
170-175	74 - 79	2011+2024
175-180	76 - 81	2012+2024



Guiador desmontable



Doble asa metálica



Rodamiento oculto



Cierre soft close



Mamparas a medida y cristales especiales

TRANSPARENTE

+45%

FROST PLUS / PARSOL
CARGLASS / MATE

+55%

*Plazo de entrega 15 días (más información en pág. 258)



Descripción	Rango	Ref.
lateral fijo TWENTY BLACK 70	66,5-69,5	2017
lateral fijo TWENTY BLACK 75	71,5-74,5	2018
lateral fijo TWENTY BLACK 80	76,5-79,5	2019
lateral fijo TWENTY BLACK 90	86,5-89,5	2020



Laterales fijos a medida (más información en página 259)

Referencias	Descripción
1375N	lateral fijo a medida TWENTY hasta 40 cm
1376N	lateral fijo a medida TWENTY de 40 hasta 80 cm
1377N	lateral fijo a medida TWENTY de 80 hasta 120 cm

*Plazo de entrega 15 días

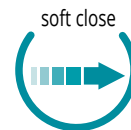
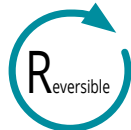
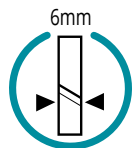
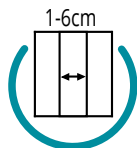
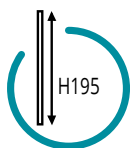

combinaciones frontales **TWENTY** + lateral fijo de 6 mm

Medida	Rangos	Referencias	Medida	Rangos	Referencias
120X70	115-120/66,5-69,5	2000+2023+2017	120X75	115-120/71,5-74,5	2000+2023+2018
125X70	120-125/66,5-69,5	2001+2023+2017	125X75	120-125/71,5-74,5	2001+2023+2018
130X70	125-130/66,5-69,5	2002+2023+2017	130X75	125-130/71,5-74,5	2002+2023+2018
135X70	130-135/66,5-69,5	2003+2023+2017	135X75	130-135/71,5-74,5	2003+2023+2018
140X70	135-140/66,5-69,5	2004+2023+2017	140X75	135-140/71,5-74,5	2004+2023+2018
145X70	140-145/66,5-69,5	2005+2023+2017	145X75	140-145/71,5-74,5	2005+2023+2018
150X70	145-150/66,5-69,5	2006+2023+2017	150X75	145-150/71,5-74,5	2006+2023+2018
155X70	150-155/66,5-69,5	2007+2024+2017	155X75	150-155/71,5-74,5	2007+2024+2018
160X70	155-160/66,5-69,5	2008+2024+2017	160X75	155-160/71,5-74,5	2008+2024+2018
165X70	160-165/66,5-69,5	2009+2024+2017	165X75	160-165/71,5-74,5	2009+2024+2018
170X70	165-170/66,5-69,5	2010+2024+2017	170X75	165-170/71,5-74,5	2010+2024+2018
175X70	170-175/66,5-69,5	2011+2024+2017	175X75	170-175/71,5-74,5	2011+2024+2018
180X70	175-180/66,5-69,5	2012+2024+2017	180X75	175-180/71,5-74,5	2012+2024+2018
Medida	Rangos	Referencias	Medida	Rangos	Referencias
120X80	115-120/76,5-79,5	2000+2023+2019	120X90	115-120/86,5-89,5	2000+2023+2020
125X80	120-125/76,5-79,5	2001+2023+2019	125X90	120-125/86,5-89,5	2001+2023+2020
130X80	125-130/76,5-79,5	2002+2023+2019	130X90	125-130/86,5-89,5	2002+2023+2020
135X80	130-135/76,5-79,5	2003+2023+2019	135X90	130-135/86,5-89,5	2003+2023+2020
140X80	135-140/76,5-79,5	2004+2023+2019	140X90	135-140/86,5-89,5	2004+2023+2020
145X80	140-145/76,5-79,5	2005+2023+2019	145X90	140-145/86,5-89,5	2005+2023+2020
150X80	145-150/76,5-79,5	2006+2023+2019	150X90	145-150/86,5-89,5	2006+2023+2020
155X80	150-155/76,5-79,5	2007+2024+2019	155X90	150-155/86,5-89,5	2007+2024+2020
160X80	155-160/76,5-79,5	2008+2024+2019	160X90	155-160/86,5-89,5	2008+2024+2020
165X80	160-165/76,5-79,5	2009+2024+2019	165X90	160-165/86,5-89,5	2009+2024+2020
170X80	165-170/76,5-79,5	2010+2024+2019	170X90	165-170/86,5-89,5	2010+2024+2020
175X80	170-175/76,5-79,5	2011+2024+2019	175X90	170-175/86,5-89,5	2011+2024+2020
180X80	175-180/76,5-79,5	2012+2024+2019	180X90	175-180/86,5-89,5	2012+2024+2020

Las aperturas son las mismas que en los frontales



Guiador desmontable



Doble asa metálica



Rodamiento oculto



Cierre soft close

COLOR

open COMBI A puerta con cierre imán a pared



COMBI A Frontal de 1 puerta con cierre imán a pared

Medida	Referencias	Descripción	Apertura	Rango
50	9004 + 9012	frontal ducha OPEN 50 con cierre imán a pared	43	51,1-52,6
55	9005 + 9012	frontal ducha OPEN 55 con cierre imán a pared	48	56,1-57,6
60	9006 + 9012	frontal ducha OPEN 60 con cierre imán a pared	53	61,1-62,6
65	9007 + 9012	frontal ducha OPEN 65 con cierre imán a pared	58	66,1-67,6
70	9008 + 9012	frontal ducha OPEN 70 con cierre imán a pared	63	71,1-72,6
75	9009 + 9012	frontal ducha OPEN 75 con cierre imán a pared	68	76,1-77,6
80	9010 + 9012	frontal ducha OPEN 80 con cierre imán a pared	73	81,1-82,6
85	9011 + 9012	frontal ducha OPEN 85 con cierre imán a pared	78	86,1-87,6

Referencias	Descripción
9015	perfil expansor puerta (+1,5 a +3 cm)
9014	perfil puerta (reduce hasta 1 cm el rango)
1221	juego gomas imán expansión +1,2 cm
1213	juego gomas apertura IN-OUT 180°

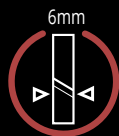

**incluye
tratamiento
antical**



Opción barra 140 cm más soporte lateral fijo - Ref. 9026+9028

apertura exterior

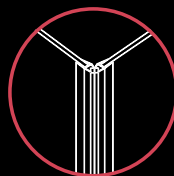

apertura in-out p/fijo

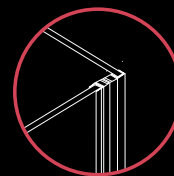

El rango del frontal en la apertura in-out aumenta en 1,4 cm y el rango del lateral fijo se reduce 1 cm Ref. 0038

COMBI A + LATERAL FIJO 70 C/BRAZO 9017

Medidas	Rangos	Referencias
50X70	50,6-52,1/66-69	9004+9012+9018+9017
55X70	55,6-57,1/66-69	9005+9012+9018+9017
60X70	60,6-62,1/66-69	9006+9012+9018+9017
65X70	65,6-67,1/66-69	9007+9012+9018+9017
70X70	70,6-72,1/66-69	9008+9012+9018+9017
75X70	75,6-77,1/66-69	9009+9012+9018+9017
80X70	80,6-82,1/66-69	9010+9012+9018+9017
85X70	85,6-87,1/66-69	9011+9012+9018+9017

COMBI A + LATERAL FIJO 80 C/BRAZO 9017

Medidas	Rangos	Referencias
50X80	50,6-52,1/76-79	9004+9012+9019+9017
55X80	55,6-57,1/76-79	9005+9012+9019+9017
60X80	60,6-62,1/76-79	9006+9012+9019+9017
65X80	65,6-67,1/76-79	9007+9012+9019+9017
70X80	70,6-72,1/76-79	9008+9012+9019+9017
75X80	75,6-77,1/76-79	9009+9012+9019+9017
80X80	80,6-82,1/76-79	9010+9012+9019+9017
85X80	85,6-87,1/76-79	9011+9012+9019+9017

COMBI A + LATERAL FIJO 90 C/BRAZO 9017

Medidas	Rangos	Referencias
50X90	50,6-52,1/86-89	9004+9012+9020+9017
55X90	55,6-57,1/86-89	9005+9012+9020+9017
60X90	60,6-62,1/86-89	9006+9012+9020+9017
65X90	65,6-67,1/86-89	9007+9012+9020+9017
70X90	70,6-72,1/86-89	9008+9012+9020+9017
75X90	75,6-77,1/86-89	9009+9012+9020+9017
80X90	80,6-82,1/86-89	9010+9012+9020+9017
85X90	85,6-87,1/86-89	9011+9012+9020+9017

Laterales fijos TRANSPARENTES 6 mm

Ref.	Descripción	Rango
9018	lateral fijo 70x195	66-69
9019	lateral fijo 80x195	76-79
9020	lateral fijo 90x195	86-89
9017	brazo open	

Ref.	Descripción
9016	perfil compensación para lateral fijo +3 cm



Laterales fijos a medida 6 mm (más información en página 259)

Descripción	Ref.
lateral fijo a medida OPEN BLACK hasta 40 cm	1345N
lateral fijo a medida OPEN BLACK de 40 hasta 80 cm	1316N
lateral fijo a medida OPEN BLACK de 80 hasta 120 cm	1317N

*Plazo de entrega 15 días.

COLOR

open COMBI B puerta con cierre perfil imán



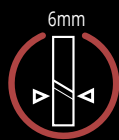

**incluye
tratamiento
antical**

COMBI B Frontal de 1 puerta con cierre perfil imán

Medida	Referencias	Descripción	Apertura	Rango
55	9004 + 9012 + 9013	OPEN 55 con cierre perfil imán	43	53,6-57,6
60	9005 + 9012 + 9013	OPEN 60 con cierre perfil imán	48	58,6-62,6
65	9006 + 9012 + 9013	OPEN 65 con cierre perfil imán	53	63,6-67,6
70	9007 + 9012 + 9013	OPEN 70 con cierre perfil imán	58	68,6-72,6
75	9008 + 9012 + 9013	OPEN 75 con cierre perfil imán	63	73,6-77,6
80	9009 + 9012 + 9013	OPEN 80 con cierre perfil imán	68	78,6-82,6
85	9010 + 9012 + 9013	OPEN 85 con cierre perfil imán	73	83,6-87,6
90	9011 + 9012 + 9013	OPEN 90 con cierre perfil imán	78	88,6-92,6

*Opción con lateral fijo, consultar fábrica.

Ref.	Descripción
9016	perfil compensación lado cierre perfil imán +3 cm
9014	perfil puerta (reduce hasta 1 cm el rango)
1221	juego gomas imán expansión +1,2 cm
9015	perfil expansor lado puerta +2,5 cm
1213	juego gomas apertura IN-OUT 180°

open COMBI C fijo + puerta abatible cierre imán a pared



Opción barra 140 cm Ref. 9026

COMBI C

FIJOS	Ref.	Rango cm
FIJO 30	9000	27,5/30
FIJO 40	9001	37,5/40
FIJO 50	9002	47,5/50
FIJO 60	9003	57,5/60

(2,5 ajuste)

PUERTAS	Ref.	Rango cm
PUERTA 50	9004	50
PUERTA 55	9005	55
PUERTA 60	9006	60
PUERTA 65	9007	65
PUERTA 70	9008	70
PUERTA 75	9009	75
PUERTA 80	9010	80
PUERTA 85	9011	85

(sin ajuste)



COMBI C

Combinación con puertas de 50, 55, 65, 70, 80 y 85

Medidas	Fijo	Puerta	Apertura	Referencia	Rango
80	30	50	43	9000+9004	77,5-80
85	30	55	48	9000+9005	82,5-85
90	40	50	43	9001+9004	87,5-90
95	30	65	53	9000+9007	92,5-95
100	30	70	63	9000+9008	97,5-100
100	50	50	43	9002+9004	97,5-100
105	40	65	58	9001+9007	102,5-105
110	30	80	73	9000+9010	107,5-110
110	40	70	63	9001+9008	107,5-110
110	60	50	43	9003+9004	107,5-110
115	50	65	58	9002+9007	112,5-115
120	40	80	73	9001+9010	117,5-120
120	50	70	63	9002+9008	117,5-120
125	60	65	58	9003+9007	122,5-125
130	50	80	73	9002+9010	127,5-130
130	60	70	63	9003+9008	127,5-130
135	60	75	68	9003+9009	132,5-135
140	60	80	73	9003+9010	137,5-140
145	60	85	78	9003+9011	142,5-145

*Permite combinación con lateral fijo Glass en lado puerta, el rango del frontal se reduce 0,5 cm.

Ref.	Descripción
9016	perfil compensación lado cierre perfil imán +3 cm
9014	perfil puerta (reduce hasta 1 cm el rango)
1221	juego gomas imán expansión +1,2 cm
9015	perfil expansor lado puerta +2,5 cm
1213	juego gomas apertura IN-OUT 180°



Opción barra 140 cm Ref. 9026.



*Opción instalación formato Free, rango -3 cm

COLOR

open COMBI C + lateral fijo



laterales fijos TRANSPARENTES 6 mm

Referencias	Descripción	Rango
9018	lateral fijo 70x195	66-69
9019	lateral fijo 80x195	76-79
9020	lateral fijo 90x195	86-89
9017	brazo open	

Referencias	Descripción
9016	perfil compensación +3 cm lado fijo



COMBI C + LATERAL FIJO 70 C/BRAZO 9017

Medidas (F+A) xLF	Referencia	Rango
80 (30+50) x70	9000+9004+9018+9017	77-79,5/66-69
85 (30+55) x70	9000+9005+9018+9017	82-84,5/66-69
90 (40+50) x70	9001+9004+9018+9017	87-89,5/66-69
95 (30+65) x70	9000+9007+9018+9017	92-94,5/66-69
100 (30+70) x70	9000+9008+9018+9017	97-99,5/66-69
100 (50+50) x70	9002+9004+9018+9017	97-99,5/66-69
105 (40+65) x70	9001+9007+9018+9017	102-104,5/66-69
110 (30+80) x70	9000+9010+9018+9017	107-109,5/66-69
110 (40+70) x70	9001+9008+9018+9017	107-109,5/66-69
110 (60+50) x70	9003+9004+9018+9017	107-109,5/66-69
115 (50+65) x70	9002+9007+9018+9017	112-114,5/66-69
120 (40+80) x70	9001+9010+9018+9017	117-119,5/66-69
120 (50+70) x70	9002+9008+9018+9017	117-119,5/66-69
125 (60+65) x70	9003+9007+9018+9017	122-124,5/66-69
130 (50+80) x70	9002+9010+9018+9017	127-129,5/66-69
130 (60+70) x70	9003+9008+9018+9017	127-129,5/66-69
135 (60+75) x70	9003+9009+9018+9017	132-134,5/66-69
140 (60+80) x70	9003+9010+9018+9017	137-139,5/66-69
145 (60+85) x70	9003+9011+9018+9017	142-144,5/66-69

COMBI C + LATERAL FIJO 80 C/BRAZO 9017

Medidas (F+A) xLF	Referencia	Rango
80 (30+50) x80	9000+9004+9019+9017	77-79,5/76-79
85 (30+55) x80	9000+9005+9019+9017	82-84,5/76-79
90 (40+50) x80	9001+9004+9019+9017	87-89,5/76-79
95 (30+65) x80	9000+9007+9019+9017	92-94,5/76-79
100 (30+70) x80	9000+9008+9019+9017	97-99,5/76-79
100 (50+50) x80	9002+9004+9019+9017	97-99,5/76-79
105 (40+65) x80	9001+9007+9019+9017	102-104,5/76-79
110 (30+80) x80	9000+9010+9019+9017	107-109,5/76-79
110 (40+70) x80	9001+9008+9019+9017	107-109,5/76-79
110 (60+50) x80	9003+9004+9019+9017	107-109,5/76-79
115 (50+65) x80	9002+9007+9019+9017	112-114,5/76-79
120 (40+80) x80	9001+9010+9019+9017	117-119,5/76-79
120 (50+70) x80	9002+9008+9019+9017	117-119,5/76-79
125 (60+65) x80	9003+9007+9019+9017	122-124,5/76-79
130 (50+80) x80	9002+9010+9019+9017	127-129,5/76-79
130 (60+70) x80	9003+9008+9019+9017	127-129,5/76-79
135 (60+75) x80	9003+9009+9019+9017	132-134,5/76-79
140 (60+80) x80	9003+9010+9019+9017	137-139,5/76-79
145 (60+85) x80	9003+9011+9019+9017	142-144,5/76-79

apertura exterior

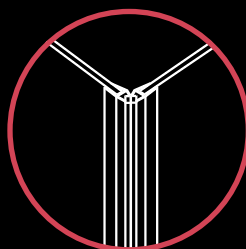

apertura in-out p/fijo

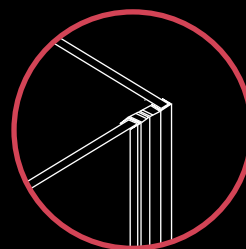

El rango del frontal en la apertura in-out aumenta en 1,4 cm y el rango del lateral fijo se reduce 1 cm Ref. 0038



COMBI C + LATERAL FIJO 90 C/BRAZO 9017

Medidas (F+A) xLF	Referencia	Rango
80 (30+50) x90	9000+9004+9020+9017	77-79,5/86-89
85 (30+55) x90	9000+9005+9020+9017	82-84,5/86-89
90 (40+50) x90	9001+9004+9020+9017	87-89,5/86-89
95 (30+65) x90	9000+9007+9020+9017	92-94,5/86-89
100 (30+70) x90	9000+9008+9020+9017	97-99,5/86-89
100 (50+50) x90	9002+9004+9020+9017	97-99,5/86-89
105 (40+65) x90	9001+9007+9020+9017	102-104,5/86-89
110 (30+80) x90	9000+9010+9020+9017	107-109,5/86-89
110 (40+70) x90	9001+9008+9020+9017	107-109,5/86-89
110 (60+50) x90	9003+9004+9020+9017	107-109,5/86-89
115 (50+65) x90	9002+9007+9020+9017	112-114,5/86-89
120 (40+80) x90	9001+9010+9020+9017	117-119,5/86-89
120 (50+70) x90	9002+9008+9020+9017	117-119,5/86-89
125 (60+65) x90	9003+9007+9020+9017	122-124,5/86-89
130 (50+80) x90	9002+9010+9020+9017	127-129,5/86-89
130 (60+70) x90	9003+9008+9020+9017	127-129,5/86-89
135 (60+75) x90	9003+9009+9020+9017	132-134,5/86-89
140 (60+80) x90	9003+9010+9020+9017	137-139,5/86-89
145 (60+85) x90	9003+9011+9020+9017	142-144,5/86-89

open COMBI D fijo + puerta abatible cierre perfil imán



COMBI D

FIJOS	Ref.	Rango cm
FIJO 30	9000	27,5/30
FIJO 40	9001	37,5/40
FIJO 50	9002	47,5/50
FIJO 60	9003	57,5/60

(2,5 ajuste)

Cierre perfil imán ref. 9013

PUERTAS	Ref.	Rango cm
PUERTA 50	9004+9013	50
PUERTA 55	9005+9013	55
PUERTA 60	9006+9013	60
PUERTA 65	9007+9013	65
PUERTA 70	9008+9013	70
PUERTA 75	9009+9013	75
PUERTA 80	9010+9013	80
PUERTA 85	9011+9013	85

(2,5 ajuste)

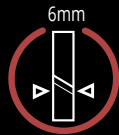

**incluye
tratamiento
antical**

COMBI D

Combinación con puertas de 50, 55, 65, 70, 80 y 85

Medidas	Fijo	Puerta	Apertura	Referencia	Rango
80	30	50	43	9000+9004+9013	80-85
85	30	55	48	9000+9005+9013	85-90
90	40	50	43	9001+9004+9013	90-95
95	30	65	53	9000+9007+9013	95-100
100	30	70	63	9000+9008+9013	100-105
100	50	50	43	9002+9004+9013	100-105
105	40	65	58	9001+9007+9013	105-110
110	30	80	73	9000+9010+9013	110-115
110	40	70	63	9001+9008+9013	110-115
110	60	50	43	9003+9004+9013	110-115
115	50	65	58	9002+9007+9013	115-120
120	40	80	73	9001+9010+9013	120-125
120	50	70	63	9002+9008+9013	120-125
125	60	65	58	9003+9007+9013	125-130
130	50	80	73	9002+9010+9013	130-135
130	60	70	63	9003+9008+9013	130-135
135	60	75	68	9003+9009+9013	135-140
140	60	80	73	9003+9010+9013	140-145
145	60	85	78	9003+9011+9013	145-150

*Permite uso perfil compensación en ambos lados

*Opción con lateral fijo, consultar fábrica.

Referencias	Descripción
9016	perfil compensación lado fijo +3 cm
1221	juego gomas imán expansión +1,2 cm
1213	juego gomas apertura IN-OUT 180°



Opción barra 140 cm Ref. 9026.

COLOR

open COMBI E fijo + puerta abatible con cierre a fijo



Opción barra 140 cm más soporte - Ref. 9026

COMBI E

FIJOS	Ref.	Rango cm
FJO 30	9000	27,5/30
FJO 40	9001	37,5/40
FJO 50	9002	47,5/50
FJO 60	9003	57,5/60
(2,5 ajuste)		
Perfil pared Open Black ref. 9012		

PUERTAS	Ref.	Rango cm
PUERTA 50	9004+9012	50
PUERTA 55	9005+9012	55
PUERTA 60	9006+9012	60
PUERTA 65	9007+9012	65
PUERTA 70	9008+9012	70
PUERTA 75	9009+9012	75
PUERTA 80	9010+9012	80
PUERTA 85	9011+9012	85

(1,5 ajuste)



COMBI E

Combinación con puertas de 50, 55, 65, 70, 80 y 85

Medidas	Fijo	Puerta	Referencia	Apertura	Rango
80	30	50	9000+9004+9012	43	78,6-82,6
85	30	55	9000+9005+9012	48	83,6-87,6
90	40	50	9001+9004+9012	43	88,6-92,6
95	30	65	9000+9007+9012	58	93,6-97,6
100	30	70	9000+9008+9012	63	98,6-102,6
100	50	50	9002+9004+9012	43	98,6-102,6
105	40	65	9001+9007+9012	58	103,6-107,6
110	30	80	9000+9010+9012	73	108,6-112,6
110	40	70	9001+9008+9012	63	108,6-112,6
110	60	50	9003+9004+9012	43	108,6-112,6
115	50	65	9002+9007+9012	58	113,6-117,6
120	40	80	9001+9010+9012	73	118,6-122,6
120	50	70	9002+9008+9012	63	118,6-122,6
125	60	65	9003+9007+9012	58	123,6-127,6
130	50	80	9002+9010+9012	73	128,6-132,6
130	60	70	9003+9008+9012	63	128,6-132,6
135	60	75	9003+9009+9012	68	133,6-137,6
140	60	80	9003+9010+9012	73	138,6-142,6
145	60	85	9003+9011+9012	78	143,6-147,6

*Opción con lateral fijo, consultar fábrica.

Ref.	Descripción
9016	perfil compensación lado fijo +3 cm
9014	perfil puerta (reduce hasta 1 cm el rango)
1221	juego gomas imán expansión +1,2 cm
9015	perfil expansor puerta +2,5 cm
1213	juego gomas apertura IN-OUT 180°

open COMBI F 2 fijos + puerta abatible con cierre a fijo



COMBI F

FIJOS	Ref.	Rango cm
FIJO 30	9000	27,5/30
FIJO 40	9001	37,5/40
FIJO 50	9002	47,5/50
FIJO 60	9003	57,5/60

ajuste 2,5x2 = 5 cm

PUERTAS	Ref.	Rango cm
PUERTA 50	9004	50
PUERTA 55	9005	55
PUERTA 60	9006	60
PUERTA 65	9007	65
PUERTA 70	9008	70
PUERTA 75	9009	75
PUERTA 80	9010	80
PUERTA 85	9011	85

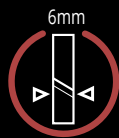

incluye
tratamiento
antical

COMBI F

Combinación con puertas de 50, 55, 65, 70, 80 y 85

Medidas (F+P+F)	Referencia	Ap.	Rango
110 (30+50+30)	9000+9004+9000	43	105-110
115 (30+55+30)	9000+9005+9000	48	110-115
120 (30+50+40)	9000+9004+9001	43	115-120
125 (30+65+30)	9000+9007+9000	58	120-125
130 (30+70+30)	9000+9008+9000	63	125-130
135 (30+65+40)	9000+9007+9001	58	130-135
140 (30+70+40)	9000+9008+9001	63	135-140
140 (30+80+30)	9000+9010+9000	73	135-140
140 (30+50+60)	9000+9004+9003	43	135-140
145 (30+65+50)	9000+9007+9002	58	140-145
145 (40+65+40)	9001+9007+9001	58	140-145
150 (40+50+60)	9001+9004+9003	43	145-150
150 (30+70+50)	9000+9008+9002	63	145-150
150 (40+70+40)	9001+9008+9001	63	145-150
150 (30+80+40)	9000+9010+9001	73	145-150
155 (30+65+60)	9000+9007+9003	58	150-155
155 (40+65+50)	9001+9007+9002	58	150-155
160 (50+50+60)	9002+9004+9003	43	155-160
160 (30+70+60)	9000+9008+9003	63	155-160

Medidas (F+P+F)	Referencia	Ap.	Rango
160 (40+70+50)	9001+9008+9002	63	155-160
160 (30+80+50)	9000+9010+9002	73	155-160
160 (40+80+40)	9001+9010+9001	73	155-160
165 (40+65+60)	9001+9007+9003	58	160-165
165 (50+65+50)	9002+9007+9002	58	160-165
170 (60+50+60)	9003+9004+9003	43	165-170
170 (40+70+60)	9001+9008+9003	63	165-170
170 (50+70+50)	9002+9008+9002	63	165-170
170 (30+80+60)	9000+9010+9003	73	165-170
170 (40+80+50)	9001+9010+9002	73	165-170
175 (50+65+60)	9002+9007+9003	58	170-175
180 (50+70+60)	9002+9008+9003	63	175-180
180 (40+80+60)	9001+9010+9003	73	175-180
180 (50+80+50)	9002+9010+9002	73	175-180
185 (60+65+60)	9003+9007+9003	58	180-185
190 (60+70+60)	9003+9008+9003	63	185-190
190 (50+80+60)	9002+9010+9003	73	185-190
195 (60+75+60)	9003+9009+9003	68	190-195
200 (60+80+60)	9003+9010+9003	73	195-200

*Opción con lateral fijo, consultar fábrica.

Ref.	Descripción
9016	perfil compensación lado fijo +3 cm
1221	juego gomas imán expansión +1,2 cm
1213	juego gomas apertura IN-OUT 180°



Opción barra 200 más soportes Ref. 9027.



COLOR

open COMBI G fijo + 2 puertas abatibles + fijo



Opción barra 200 más soportes Ref. 9027.

COMBI G

FIJOS	Ref.	Rango cm
FIJO 30	9000	27,5/30
FIJO 40	9001	37,5/40
FIJO 50	9002	47,5/50
FIJO 60	9003	57,5/60

ajuste 2,5x2 = 5 cm

PUERTAS	Ref.	Rango cm
PUERTA 50	9004	50
PUERTA 55	9005	55
PUERTA 60	9006	60
PUERTA 65	9007	65
PUERTA 70	9008	70
PUERTA 75	9009	75
PUERTA 80	9010	80
PUERTA 85	9011	85

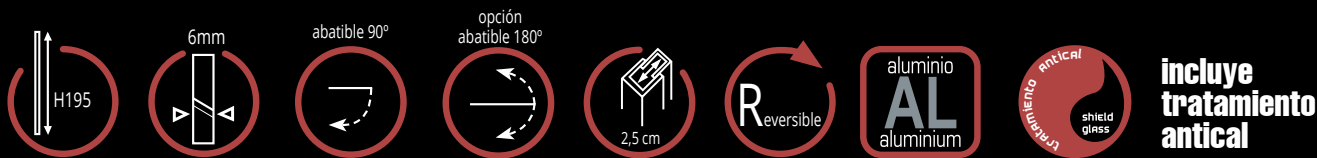

COMBI G

Combinación con puertas 50, 65, 70 y 80

Medidas (F+P+P+F)	Referencia	Rango
155 (30+50+50+30)	9000x2+9004x2	151,2 - 156,2
165 (30+50+50+40)	9000+9001+9004x2	161,2 - 166,2
175 (30+50+50+50)	9000+9002+9004x2	171,2 - 176,2
175 (40+50+50+40)	9001x2+9004x2	171,2 - 176,2
185 (40+50+50+50)	9001+9002+9004x2	181,2 - 186,2
185 (30+50+50+60)	9000+9003+9004x2	181,2 - 186,2
185 (30+65+65+30)	9000x2+9007x2	181,2 - 186,2
195 (50+50+50+50)	9002x2+9004x2	191,2 - 196,2
195 (40+50+50+60)	9001+9003+9004x2	191,2 - 196,2
195 (30+65+65+40)	9000+9001+9007x2	191,2 - 196,2
195 (30+70+70+30)	9000x2+9008x2	191,2 - 196,2
205 (40+65+65+40)	9001x2+9007x2	201,2 - 206,2
205(30+65+65+50)	9000+9002+9007x2	201,2 - 206,2
205 (30+70+70+40)	9000+9001+9008x2	201,2 - 206,2
205 (50+50+50+60)	9002+9003+9004x2	201,2 - 206,2
215 (30+65+65+60)	9000+9003+9007x2	211,2 - 216,2
215 (40+65+65+50)	9001+9002+9007x2	211,2 - 216,2
215 (30+70+70+50)	9000+9002+9008x2	211,2 - 216,2
215 (40+70+70+40)	9001x2+9008x2	211,2 - 216,2
215 (30+80+80+30)	9000x2+9010x2	211,2 - 216,2

COMBI G

Combinación con puertas 50, 65, 70 y 80

Medidas (F+P+P+F)	Referencia	Rango
215 (60+50+50+60)	9003x2+9004x2	211,2 - 216,2
225 (50+65+65+50)	9002x2+9007x2	221,2 - 226,2
225 (40+65+65+60)	9001+9003+9007x2	221,2 - 226,2
225 (30+70+70+60)	9000+9003+9008x2	221,2 - 226,2
225 (40+70+70+50)	9001+9002+9008x2	221,2 - 226,2
225 (30+80+80+40)	9000+9001+9010x2	221,2 - 226,2
235 (50+65+65+60)	9002+9003+9007x2	231,2 - 236,2
235 (40+70+70+60)	9001+9003+9008x2	231,2 - 236,2
235 (50+70+70+50)	9002x2+9008x2	231,2 - 236,2
235 (40+80+80+40)	9001x2+9010x2	231,2 - 236,2
245 (60+65+65+60)	9003x2+9007x2	241,2 - 246,2
245 (50+70+70+60)	9002+9003+9008x2	241,2 - 246,2
245 (30+80+80+60)	9000+9003+9010x2	241,2 - 246,2
245 (40+80+80+50)	9001+9002+9010x2	241,2 - 246,2
255 (60+70+70+60)	9003x2+9008x2	251,2 - 256,2
255 (40+80+80+60)	9001+9003+9010x2	251,2 - 256,2
255 (50+80+80+50)	9002x2+9010x2	251,2 - 256,2
265 (50+80+80+60)	9002+9003+9010x2	261,2 - 266,2
275 (60+80+80+60)	9003x2+9010x2	271,2 - 276,2

*Opción con lateral fijo, consultar fábrica.

Ref.	Descripción
9016	perfil compensación lado fijo +3 cm
1221	juego gomas imán expansión +1,2 cm



Opción barra 200 más soportes Ref. 9027.

open COMBI H angular 2 puertas abatibles + 2 fijos



COMBI H

FIJOS	Ref.	Rango cm
FIJO 30	9000	27,5/30
FIJO 40	9001	37,5/40
FIJO 50	9002	47,5/50
FIJO 60	9003	57,5/60

(ajuste 2,5 cm)

PUERTAS	Ref.	Rango cm
PUERTA 50	9004	50
PUERTA 55	9005	55
PUERTA 60	9006	60
PUERTA 65	9007	65
PUERTA 70	9008	70
PUERTA 75	9009	75
PUERTA 80	9010	80
PUERTA 85	9011	85

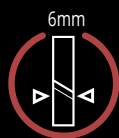

**incluye
tratamiento
antical**

COMBI H

Combinación con puertas 50, 65, 70 y 80

Medidas (F+P+P+F)	Referencia	Rango
80x80(30+50+50+30)	9000x2+ 9004x2	77-79,5 / 77-79,5
90x90(40+50+50+40)	9001x2+9004x2	87-89,5 / 87-89,5
95x95(30+65+65+30)	9000x2+9007x2	92-94,5 / 92-94,5
100x100(30+70+70+30)	9000x2+9008x2	97-99,5 / 97-99,5
100x100(50+50+50+50)	9002x2+9004x2	97-99,5 / 97-99,5
90x80(40+50+50+30)	9001+9000+9004x2	87-89,5 / 77-79,5
95x80(30+65+50+30)	9000+9007+9000+9004	92-94,5 / 77-79,5
100x80(30+70+50+30)	9000+9008+9000+9004	97-99,5 / 77-79,5
105x80(40+65+50+30)	9001+9007+9000+9004	102-104,5 / 77-79,5
110x80(60+50+50+30)	9003+9004+9000+9004	107-109,5 / 77-79,5
110x80(40+70+50+30)	9001+9008+9000+9004	107-109,5 / 77-79,5
110x80(30+80+50+30)	9000x2+9010+9004	107-109,5 / 77-79,5
115x80(50+65+50+30)	9002+9007+9000+9004	112-114,5 / 77-79,5
120x80(50+70+50+30)	9002+9008+9000+9004	117-119,5 / 77-79,5
120x80(40+80+50+30)	9001+9010+9000+9004	117-119,5 / 77-79,5
125x80(60+65+50+30)	9003+9007+9000+9004	122-124,5 / 77-79,5

COMBI H

Combinación con puertas 50, 65, 70 y 80

Medidas (F+P+P+F)	Referencia	Rango
130x80(50+80+50+30)	9002+9010+9000+9004	127-129,5 / 77-79,5
130x80(60+70+50+30)	9003+9008+9000+9004	127-129,5 / 77-79,5
140x80(60+80+50+30)	9003+9010+9000+9004	137-139,5 / 77-79,5
95x90(30+65+50+40)	9000+9007+9001+9004	92-94,5 / 87-89,5
100x90(30+70+50+40)	9000+9008+9001+9004	97-99,5 / 87-89,5
105x90(40+65+50+40)	9001x2+9007+9004	102-104,5 / 87-89,5
110x90(60+50+50+40)	9003+9001+9004x2	107-109,5 / 87-89,5
110x90(40+70+50+40)	9001x2+9008+9004	107-109,5 / 87-89,5
110x90(30+80+50+40)	9000+9010+9001+9004	107-109,5 / 87-89,5
115x90(50+65+50+40)	9002+9007+9001+9004	112-114,5 / 87-89,5
120x90(50+70+50+40)	9002+9008+9001+9004	117-119,5 / 87-89,5
120x90(40+80+50+40)	9001x2+9010+9004	117-119,5 / 87-89,5
125x90(60+65+50+40)	9003+9007+9001+9004	122-124,5 / 87-89,5
130x90(60+70+50+40)	9003+9008+9001+9004	127-129,5 / 87-89,5
130x90(50+80+50+40)	9002+9010+9001+9004	127-129,5 / 87-89,5
140x90(60+80+50+40)	9003+9010+9001+9004	137-139,5 / 87-89,5

Ref.	Descripción
9016	perfil compensación lado fijo +3 cm

open COMBI | 2 puertas abatibles



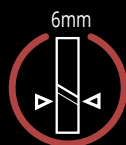

**incluye
tratamiento
antical**

COMBI I Combinación con puertas de 50, 55, 65, 70, 80 y 85

Medidas (P+P)	Referencias	Apert.	Rango
100 (50+50)	9004x2+9012x2	86	99-102
105 (50+55)	9004+9005+9012x2	91	104-107
110 (55+55)	9005x2+9012x2	96	109-112
115 (55+60)	9005+9006+9012x2	101	114-117
120 (60+60)	9006+9006+9012x2	106	119-122
125 (60+65)	9006+9007+9012x2	111	124-127
130 (65+65)	9007x2+9012x2	116	129-132
135 (65+70)	9007+9008+9012x2	121	134-137
140 (70+70)	9008x2+9012x2	126	139-142
145 (70+75)	9008+9009+9012x2	131	144-147
150 (75+75)	9009x2+9012x2	136	149-152
155 (75+80)	9009+9010+9012x2	141	154-157
160 (80+80)	9010x2+9012x2	146	159-162
165 (80+85)	9010+9011+9012x2	151	164-167
170 (85+85)	9011x2+9012x2	156	169-172

*Opción con lateral fijo, consultar fábrica.

Ref.	Descripción
1221	juego gomas imán expansión +1,2 cm
9015	perfil expansor puerta +2,5 cm
9014	perfil puerta (reduce hasta 1 cm el rango)

open COMBI J 1 fijo +2 puertas abatibles



COMBI J

FIJOS	Ref.	Rango cm
FIJO 30	9000	27,5/30
FIJO 40	9001	37,5/40
FIJO 50	9002	47,5/50
FIJO 60	9003	57,5/60

(2,5 ajuste)

Perfil pared Open Black ref. 9012

PUERTAS	Ref.	Rango cm
PUERTA 50	9004	50
PUERTA 55	9005	55
PUERTA 60	9006	60
PUERTA 65	9007	65
PUERTA 70	9008	70
PUERTA 75	9009	75
PUERTA 80	9010	80
PUERTA 85	9011	85

(1,5 ajuste)

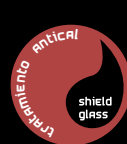
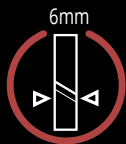

incluye
tratamiento
antical

COMBI J Combinación con puertas de 50, 55, 65, 70, 75 y 80

Medidas (P+P+F)	Referencias	Apertura	Rango
125 (50+50+30)	9004x2+9000+9012	86	124,8/128,8
130 (50+55+30)	9004+9005+9000+9012	91	129,8/133,8
135 (50+50+40)	9004x2+9001+9012	86	134,8/138,8
140 (60+55+30)	9006+9005+9000+9012	101	139,8/143,8
145 (50+50+50)	9004x2+9002+9012	86	144,8/148,8
150 (60+60+30)	9006x2+9000+9012	106	149,8/153,8
155 (55+55+50)	9005x2+9002+9012	96	154,8/158,8
160 (60+55+50)	9006+9005+9002+9012	101	159,8/163,8
165 (65+65+40)	9007x2+9001+9012	116	164,8/168,8
170 (75+70+30)	9009+9008+9000+9012	121	169,8/173,8
175 (75+75+30)	9009x2+9000+9012	136	174,8/178,8
180 (80+75+30)	9010+9009+9000+9012	141	179,8/183,8
185 (80+80+30)	9010x2+9000+9012	146	184,8/188,8
190 (65+70+60)	9007+9008+9003+9012	121	189,8/193,8
195 (75+75+50)	9009x2+9002+9012	136	194,8/198,8
200 (75+80+50)	9009+9010+9002+9012	131	199,8/203,8
205 (80+80+50)	9010x2+9002+9012	146	204,8/208,8
210 (80+75+60)	9009+9010+9003+9012	141	209,8/213,8
215 (80+80+60)	9010x2+9003+9012	146	214,8/218,8

*Opción con lateral fijo, consultar fábrica.

Ref.	Descripción
9016	perfil compensación lado fijo +3 cm
9014	perfil puerta (reduce hasta 1 cm el rango)
1221	juego gomas imán expansión +1,2 cm
9015	perfil expansor puerta +2,5 cm



Opción barra 200 más soportes Ref. 9027.



COLOR

Screen Black Chess

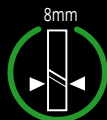

incluye tratamiento antical

combinación con referencias 0983+0990



combinación con referencias 0983+0986+0990



Medida	Rangos	Ref.
Screen Black Chess 70x195	67/69,5	0980
Screen Black Chess 80x195	77/79,5	0981
Screen Black Chess 90x195	87/89,5	0982
Screen Black Chess 100x195	97/99,5	0983
Screen Black Chess 110x195	107/109,5	0984
Screen Black Chess 120x195	117/119,5	0985
Black Chess móvil 35x195 derecha		0986
Black Chess móvil 35x195 izquierda		0987
Brazo orientable negro ajustable 60-120 cm		0990

Opción rodapie negro 2 m



Ref.
0993

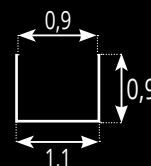

Screen Black Chess XXL

combinación con referencias 2x0980+0990+0992



COLOR

Ref.	Descripción
0992	perfil unión negro para 2 cristales fijos

Utiliza el nuevo perfil unión ref. 0992 para unir cualquiera de las referencias de fijos Screen Black Chess y conseguir medidas superiores a 120 cm.

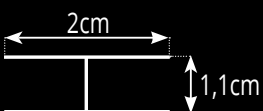

combinación con referencias 0980+0983+0991+0990



Black Chess angular

Referencia	Descripción
0991	Perfil negro en ángulo

*Aumenta 1,3 cm en uno de los lados

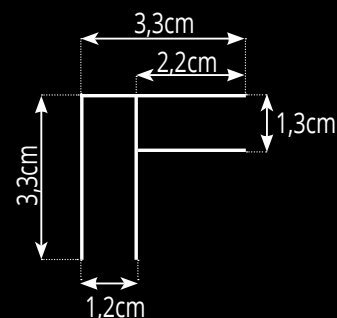

Screen Black

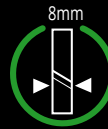

**incluye
tratamiento
antical**



Descripción	Ref.
Screen Black 68-70 + brazo ajustable 60-120 cm	SC70N
Screen Black 78-80 + brazo ajustable 60-120 cm	SC80N
Screen Black 88-90 + brazo ajustable 60-120 cm	SC90N
Screen Black 98-100 + brazo ajustable 60-120 cm	SC100N
Screen Black 108-110 + brazo ajustable 60-120 cm	SC110N
Screen Black 118-120 + brazo ajustable 60-120 cm	SC120N
Screen Black Frost Plus 68-70 + brazo ajustable 60-120 cm	SC70FN
Screen Black Frost Plus 78-80 + brazo ajustable 60-120 cm	SC80FN
Screen Black Frost Plus 88-90 + brazo ajustable 60-120 cm	SC90FN
Screen Black Frost Plus 98-100 + brazo ajustable 60-120 cm	SC100FN
Screen Black Frost Plus 108-110 + brazo ajustable 60-120 cm	SC110FN
Screen Black Frost Plus 118-120 + brazo ajustable 60-120 cm	SC120FN

Screen especiales y a medida

Ref.	Descripción	Ref.	Descripción
1305N	Ancho < 80 cm / Altura hasta 195 cm	1311N	Ancho de 80 a 120 cm / Altura hasta 195 cm
1313	Incremento FROST PLUS ancho < 80 cm	1315	Incremento FROST PLUS ancho 80-120 cm

Estos precios incluyen todos los componentes para su montaje excepto el brazo en el modelo Screen Black ref. 0990

Plazo de entrega 15 días.

Screen Black móvil bisagra 180



	TRANSPARENTE	FROST PLUS
Descripción	Ref.	Ref.
móvil de 35 cm	0331+9021	0332+9021

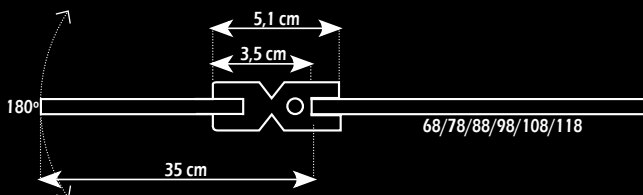

móvil Screen bisagra a medida

	TRANSPARENTE	FROST PLUS
Descripción	Ref.	Ref.
hasta 40 cm	1355N	1357N
de 40 a 80 cm	1356N	1358N

Screen Black transparente panel fijo bañera 150x85



Ref.	Descripción
0118+0017+0990	Panel fijo black 85

Incluye brazo orientable recto/45° ajustable 60-120 cm

Screen Black frost plus panel fijo bañera 150x85



Ref.	Descripción
0119+0017+0990	Panel fijo black frost plus 85

Incluye brazo orientable recto/45° ajustable 60-120 cm

Screen White

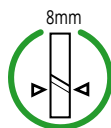

Descripción	Ref.
Screen White 68-70 + brazo ajustable 60-120 cm	SC70B
Screen White 78-80 + brazo ajustable 60-120 cm	SC80B
Screen White 88-90 + brazo ajustable 60-120 cm	SC90B
Screen White 98-100 + brazo ajustable 60-120 cm	SC100B
Screen White 108-110 + brazo ajustable 60-120 cm	SC110B
Screen White 118-120 + brazo ajustable 60-120 cm	SC120B
Screen White Frost Plus 68-70 + brazo ajustable 60-120 cm	SC70FB
Screen White Frost Plus 78-80 + brazo ajustable 60-120 cm	SC80FB
Screen White Frost Plus 88-90 + brazo ajustable 60-120 cm	SC90FB
Screen White Frost Plus 98-100 + brazo ajustable 60-120 cm	SC100FB
Screen White Frost Plus 108-110 + brazo ajustable 60-120 cm	SC110FB
Screen White Frost Plus 118-120 + brazo ajustable 60-120 cm	SC120FB

Screen especiales a medida

Ref.	Descripción	Ref.	Descripción
1305B	Ancho < 40 cm / Altura hasta 195 cm	1311B	Ancho de 40 a 120 cm / Altura hasta 195 cm
1313	Incremento FROST PLUS ancho < 80 cm	1315	Incremento FROST PLUS ancho 80-120 cm

Estos precios incluyen todos los componentes para su montaje excepto el brazo en el modelo Screen White ref. 0186

Plazo de entrega 15 días.

Screen White móvil bisagra 180°



	TRANSPARENTE	FROST PLUS
Descripción	Ref.	Ref.
móvil de 35 cm	0331+0333	0332+0333

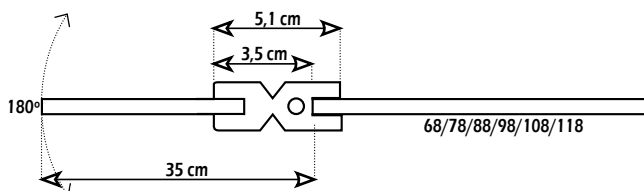

MÓVIL SCREEN BISAGRA A MEDIDA

	TRANSPARENTE	FROST PLUS
Descripción	Ref.	Ref.
hasta 40 cm	1355B	1357B
de 40 a 80 cm	1356B	1358B

Plazo de entrega 15 días.

Screen White

panel fijo bañera 150x85



Ref.	Descripción
0118+0016+0186	Panel fijo white 85

Incluye brazo orientable recto/45° ajustable 60-120 cm

Screen White frost plus

panel fijo bañera 150x85



Ref.	Descripción
0119+0016+0186	Panel fijo white frost plus 85

Incluye brazo orientable recto/45° ajustable 60-120 cm



GLASS PLEGABLE pg.250

FIJO SCREEN pg.251



BLACK pg.245 - WHITE pg. 247

OPEN 1 pg.252

OPEN 2 pg.253

AKTUAL pg.254



BAÑERA

MAMPARAS DE BAÑERA

panel bañera **glass** transparente
100x145cm

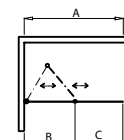
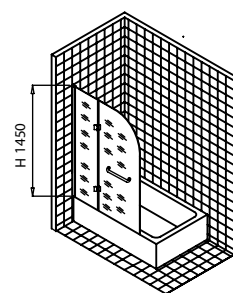
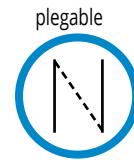
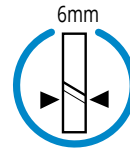
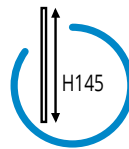

A	B	C
1000	380	620

Referencias

Descripción

0076	panel de bañera GLASS izquierda
0077	panel de bañera GLASS derecha

perfil aluminio cromo brillo
dos hojas plegables
vidrio templado 6mm
bisagras en latón
tirador/toallero cromado
elevación al girar

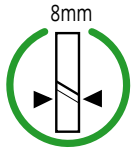
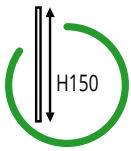

panel fijo bañera 150x85
Screen transparente

Ref.	Descripción
0118	Panel fijo 85

Incluye brazo orientable recto/45° ext. (60-120)

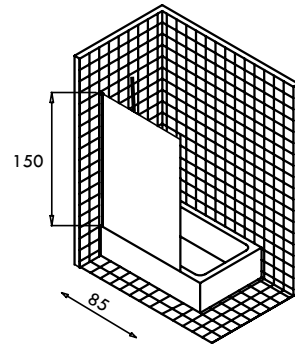

perfil aluminio cromo brillo
vidrio templado 8mm
brazo orientable



panel fijo bañera 150x85
Screen frost plus

Ref.	Descripción
0119	Panel fijo frost plus 85

Incluye brazo orientable recto/45° ext. (60-120)

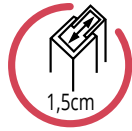
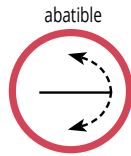
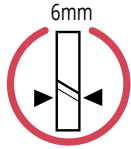
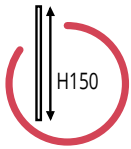

panel bañera 150x85
open 1 transparente

Ref.	Descripción
0121	Panel open 1 transparente

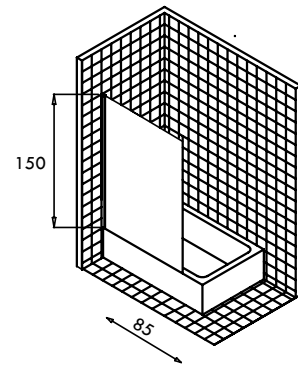

perfil aluminio cromo brillo
vidrio templado 6mm
elevación al girar



panel bañera 150x85
open 1 frost plus

Ref.	Descripción
0123	Panel open 1 frost plus

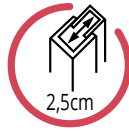
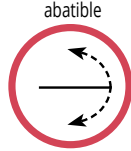
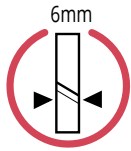
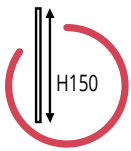

panel bañera 150x122
open 2 transparente

Ref.	Descripción
0120+0121	Panel open 2 transparente

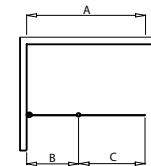
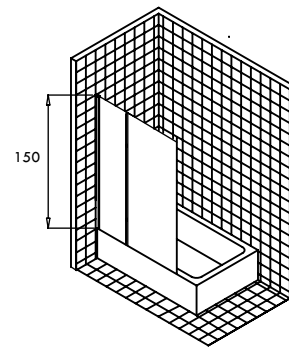

A	B	C
120	37	83

perfil aluminio cromo brillo
 vidrio templado 6mm
 elevación al girar



panel bañera 150x122
open 2 frost plus

Ref.	Descripción
0122+0123	Panel open 2 frost plus

frontal de bañera **aktual**



frontal **BAÑERA AKTUAL**

Medida	Rangos	Apertura	TRANSPARENTE	FROST PLUS
			Referencias	Referencias
140	136-142	58	0111	0125
150	146-152	63	0112	0126
160	156-162	58	0113	0127
170	166-172	63	0114	0128
180	176-182	63	0115	0129

Referencias	Descripción
0110	perfil de compensación (aumenta 4 cm)

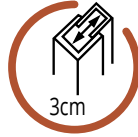
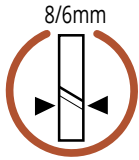
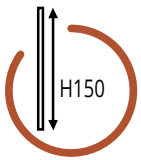

doble rodamiento antivuelco



tirador metálico



vierteaguas metálico



Lateral fijo STD 70

Medida	Rango	TRANSPARENTE Referencias	FROST PLUS Referencias
70	66-69	0098	0130

Frontales **AKTUAL** + lat. fijo

Medidas	Rangos	Apert.	TRANSPARENTE Referencias	FROST PLUS Referencias
combinaciones c/ LATERAL 70 fijo				
140x70	136,5-139,5 / 66-69	58	0111 + 0098	0125 + 0130
150x70	146,5-149,5 / 66-69	63	0112 + 0098	0126 + 0130
160x70	156,5-159,5 / 66-69	58	0113 + 0098	0127 + 0130
170x70	166,5-169,5 / 66-69	63	0114 + 0098	0128 + 0130
180x70	176,5-179,5 / 66-69	63	0115 + 0098	0129 + 0130

Referencias	Descripción
0110	perfil de compensación (aumenta 4 cm)



Laterales fijos a medida

Descripción	TRANSPARENTE Ref.	FROST PLUS Ref.
lateral fijo a medida hasta 40 cm	1343	1343+1312
lateral fijo a medida de 40 hasta 80 cm	1304	1304+1313
lateral fijo a medida de 80 hasta 120 cm	1310	1310+1315

*Plazo de entrega 15 días. Ver página 259.

frontal de bañera **aktual spazio**



frontal **BAÑERA AKTUAL SPAZIO**

Medida	Rangos	Apertura	TRANSPARENTE	FROST PLUS
			Referencias	Referencias
140	136-142	53	0530	0535
150	146-152	58	0531	0536
160	156-162	63	0532	0537
170	166-172	68	0533	0538
180	176-182	73	0534	0539

Referencias	Descripción
0110	perfil de compensación (aumenta 4 cm)

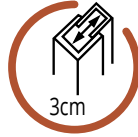
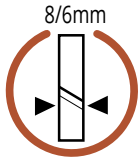
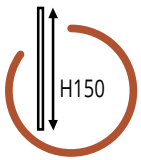

doble rodamiento antivuelco



tirador metálico



vierteaguas metálico



Lateral fijo STD 70

Medida	Rango	TRANSPARENTE Referencias	FROST PLUS Referencias
70	66-69	0098	0130

AKTUAL SPAZIO + lat. fijo

Medidas	Rangos	Apert.	TRANSPARENTE Referencias	FROST PLUS Referencias
combinaciones c/ LATERAL 70 fijo				
140x70	136,5-139,5 / 66-69	53	0530 + 0098	0535 + 0130
150x70	146,5-149,5 / 66-69	58	0531 + 0098	0536 + 0130
160x70	156,5-159,5 / 66-69	63	0532 + 0098	0537 + 0130
170x70	166,5-169,5 / 66-69	68	0533 + 0098	0538 + 0130
180x70	176,5-179,5 / 66-69	73	0534 + 0098	0539 + 0130

Referencias	Descripción
0110	perfil de compensación (aumenta 4 cm)



Laterales fijos a medida	TRANSPARENTE Ref.	FROST PLUS Ref.
lateral fijo a medida hasta 40 cm	1343	1343+1312
lateral fijo a medida de 40 hasta 80 cm	1304	1304+1313
lateral fijo a medida de 80 hasta 120 cm	1310	1310+1315

*Plazo de entrega 15 días. Ver página 259.

mamparas correderas a medida y especiales

futura / rotary / temple / basic / vitro / twenty



MAMPARAS A MEDIDA TRANSPARENTES

ALTURA 195 CM
REF. 0868

(SOLO BASIC)

ALTURA 196 A 220 CM
REF. 0871

+45%

+75%

* Para el cálculo del punto se incrementará un 45% al punto de la referencia que cubra ese rango o la inmediatamente superior.

* Indicar Modelo / Referencia / Medida.

* No se aceptan medidas superiores a la mayor de la tabla, ni alturas superiores a la standard.

(SOLO BASIC)

MAMPARAS A MEDIDA TRANSPARENTES ACABADOS ESPECIALES	ALTURA 195 CM REF. 0870	ALTURA 196 A 220 CM REF. 0872
Acabado serigrafía FROST PLUS ÁCIDO	+55%	+85%
Acabado PARSOL		
Acabado CARGLASS / MATE		

* Para el cálculo del punto se incrementará un 55% al punto de la referencia que cubra ese rango o la inmediatamente superior

* Es necesario indicar la posición de la puerta y el fijo

* Indicar Modelo / Referencia / Medida

* No se aceptan medidas superiores a la mayor de la tabla, ni alturas superiores a la standard.

CARGLASS 6 mm



FROST PLUS



Parsol VERDE



Parsol BRONCE



MATE



mamparas abatibles a medida

open / glass / glass plegable transparentes

MODELO	Ancho < 40 cm	Ancho > 40 y < 80 cm	Ancho > 80 y < 120 cm
Panel fijo Open 6 mm	Ref. 1345	Ref. 1316	Ref. 1317
Panel fijo Glass 8 mm	1339	1336	1337

*No incluye brazo Open ni Glass

MODELO	Ancho < 80 cm
Puerta Glass / Glass Plegable	Ref. 1338

Perfilería y herrajes

Ref.	Descripción
1735	Perfilería y herrajes para fijo Glass a medida
1736	Perfilería y herrajes para puerta Glass a medida

*Incluye todo excepto el cristal

Plazo medio de entrega **15 días**

*No se aceptarán devoluciones ni anulaciones de cristales a medida

laterales fijos a medida

MODELO
Lateral Fijo 8 mm VETRUM
Lateral Fijo 8 mm MOVING
Lateral Fijo 8 mm TEMPLE
Lateral Fijo 6 mm TRIO
Lateral Fijo 6 mm BYPASS
Lateral Fijo 8 mm FUTURA
Lateral Fijo 8 mm ROTARY
Lateral Fijo 8 mm BASIC
Lateral Fijo 8 mm BASIC NEGRA
Lateral Fijo 8 mm BASIC BLANCA
Lateral Fijo 8 mm BASIC TITANIO
*Lateral fijo 6 mm OPEN / GLASS / GLASS PLEGABLE
*Lateral fijo 6 mm OPEN NEGRO
Lateral fijo 8 mm VITRO
Lateral fijo 8 mm KENNA
Lateral fijo 6 mm TWENTY
Lateral fijo 6 mm TWENTY BLACK
*Fijo STD 8 mm AKTUAL / PRESTIGE TITAN / AKORD / OPEN / GLASS / GLASS PLEGABLE / GIRO
*Fijo STD NEGRO 8 mm

Ancho <40 cm	Ancho >40 y <80 cm	Ancho >80 y <120 cm
Ref.	Ref.	Ref.
1340	1300	1306
1341	1301	1307
1349	1302	1308
1342	1303	1309
1346	1318	1319
1347	1330	1331
1348	1332	1333
1350	1334	1335
1350N	1334N	1335N
1350B	1334B	1335B
1350T	1334T	1335T
1345	1316	1317
1345N	1316N	1317N
1351	1352	1353
1365	1366	1367
1375	1376	1377
1375N	1376N	1377N
1343	1304	1310
1343N	1304N	1310N

*No incluye brazo

Incremento acabado FROST PLUS

1312

1313

1315

*Indicar la posición del lateral

Cajonado (excepto modelo Vetrum)

Ref.	Descripción
0862	Corte Escuadra/Cajonado

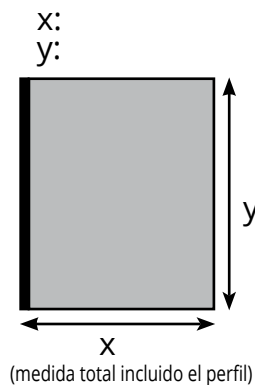

En caso de llevar cajonado, indique ubicación

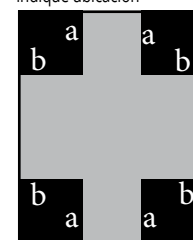

CAJONADO
a:
b:

acabados especiales

Distintos acabados en **LATERALES FIJOS A MEDIDA 6 mm** puntos +35%

CARGLASS



Parsol VERDE

Parsol BRONCE

MATE



Plazo medio **15 días**
de entrega

*No se aceptarán devoluciones ni anulaciones de cristales a medida

Tubos Compensación Montaje (incluye tapa y herrajes)

Referencias	Descripción
0001	Tubo compensación 40x20x2000 mm
0002	Tubo compensación 40x40x2000 mm
0002N	Tubo compensación negro mate 40x40x2000 mm
0003	Tubo compensación 40x60x2000 mm
0004	Ángulo 30x30x2000 mm
0009	Tubo compensación INOX 40x20x2000 mm
0010	Tubo compensación INOX 40x40x2000 mm

Perfilería y herrajes para laterales fijos a medida

Referencias	Descripción
0821	Perfilería y herrajes para fijos STD a medida
9023	Perfilería y herrajes para fijos STD NEGRO a medida
5128	Perfilería y herrajes para fijos TEMPLE a medida
0006	Perfilería y herrajes para fijos TRIO a medida
0822	Perfilería y herrajes para fijos SCREEN a medida
1081	Perfilería y herrajes para fijos MOVING a medida
1080	Perfilería y herrajes para fijos VETRUM a medida
0824	Perfilería y herrajes para fijos OPEN a medida
9022	Perfilería, herrajes y brazo para fijos OPEN BLACK a medida
1277	Perfilería y herrajes para fijos BYPASS a medida
5228	Perfilería y herrajes para fijos ROTARY a medida
5328	Perfilería y herrajes para fijos FUTURA a medida
5428	Perfilería y herrajes para fijos BASIC a medida
5492	Perfilería y herrajes para fijos BASIC NEGRA a medida
5588	Perfilería y herrajes para fijos BASIC BLANCA a medida
5567	Perfilería y herrajes para fijos BASIC TITANIO a medida
6552	Perfilería y herrajes para fijos KENNA a medida
2025	Perfilería y herrajes para fijos TWENTY a medida
2026	Perfilería y herrajes para fijos TWENTY NEGRA a medida
0330	Kit bisagras SCREEN

*Incluye todo excepto el cristal

OPCIONES MAMPARAS

REF. 1731 /1732 TIRADOR EXTRAPLANO: Gana 7 cm de paso de entrada en medidas intermedias y 2 cm en el resto.

REF.1072 OPCIÓN CIERRE PERFIL+JUNTA BURBUJA: Sistema de cierre con perfil en "U" a pared y goma anti golpes en puerta "C".

REF.1075 PERFIL UNIÓN FIJO+LATERAL FIJO: En Vetrum y Moving permite la instalación del lateral fijo al fijo del frontal en lugar de a la puerta (foto). Solo válido para laterales fijos a medida, si se aplica para un lateral fijo de serie perderá 5 cm de rango.

En Temple/Rotary/Basic no altera ni las referencias ni los rangos de la combinación puerta-fijo, por lo que solo se deberá indicar la posición dónde va a instalarse el fijo.

REF.0007 EMBELLECEDOR ALUMINIO TRIO/BASIC: Pletina de aluminio pulido para cubrir el espacio entre el límite del plato y el perfil de cierre. Se usa cuando la cerámica es distinta en el interior de la mampara. Dimensiones 195x3,8 cm.

REF.0008 EMBELLECEDOR ACERO FUTURA/ROTARY/TEMPLE: Pletina de acero pulido para cubrir el espacio entre el límite del plato y el perfil de cierre. Se usa cuando la cerámica es distinta en el interior de la mampara. Dimensiones 195x3,8 cm.

REF 1221 IMÁN DE EXPANSIÓN +1,2 OPEN: juego de imanes magnéticos 1,2 cm más ancho que permite aumentar el rango de la combinación 1,2 cm.

REF.1222 PERFIL EXPANSIÓN PUERTA OPEN: Se usa como compensación del perfil de las puertas Open. La ref. 1222 también hace posible la unión del perfil de la puerta a los laterales fijos STD.

REF.1215 PERFIL PUERTA OPEN: sustituyendo el perfil 1211 por este perfil se reduce hasta 1 cm el rango de la combinación.

MEDIDAS Y PRECIOS DE PERFILERÍA (cm)

Perfiles verticales de pared del fijo

AKTUAL / PRESTIGE TITAN SLIM / AKORD / GLASS	VETRUM	MOVING	FUTURA / TEMPLE ROTARY	BASIC VITRO	OPEN GIRO	KENNA
puntos de perfiles verticales del fijo						

TWENTY	SCREEN	SCREEN BLACK
puntos de perfiles verticales del fijo		

Perfiles verticales de pared del cierre de la puerta

VETRUM MOVING	FUTURA	BASIC / TEMPLE ROTARY / VITRO	OPEN	TRIO	BYPASS	PRESTIGE TITAN	KENNA
puntos de perfiles verticales de la corredera							









Perfiles horizontales superiores

ROTARY	TEMPLE	BASIC	FUTURA	BYPASS	TRIO
Alto 3,8 Ancho 0,8	Alto 4,2 Ancho 1,3	Alto 4,8 Ancho 2,3	Alto 2,5 Ancho 3,1	Alto 4 Ancho 6	Alto 5,7 Ancho 5,7







Perfiles horizontales superiores

AKTUAL PRESTIGE	MOVING	GIRO	TWENTY	PUERTA DE PASO
Alto 4,5 Ancho 2	Ø2,5	Alto 3 Ancho 0,9	Alto 2 Ancho 3,1	

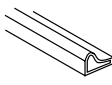
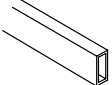

SOPORTES DE PARED

ROTARY	TEMPLE	BASIC	FUTURA	MOVING	BYPASS	TRIO	GIRO
							
Alto 4,5 Ancho 3,3	Alto 5,4 Ancho 3,8	Alto 5,8 Ancho 5,2	Alto 3,5 Ancho 6	Ø3	Alto 5,4 Ancho 7	Alto 6,2 Ancho 6,6	Alto 3,7 Ancho 4,5
puntos de soportes de pared por unidad							





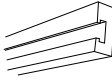

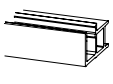

PERFILES HORIZONTALES INFERIORES (VIERTEAGUAS METÁLICOS)

FUTURA /ROTARY TEMPLE/BASIC/GLASS	MOVING GIRO	BYPASS	TRIO	AKTUAL	VETRUM	OPEN	GLASS PLEGABLE
							
1x0,6 cm	0,9x0,9 cm	1,6x1,1 cm	1,1x1 cm	0,8x1,2 cm	1,8x0,8 cm	0,6x0,6 cm	1x0,5 cm







PERFILES HORIZONTALES INFERIORES

VITRO	TWENTY	KENNA
		
1x2,3 cm	1,6x0,9 cm	1,6x2,9 cm

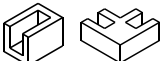
GUÍAS INFERIORES

FUTURA	ROTARY / TEMPLE BASIC	MOVING	AKTUAL	VETRUM	BYPASS	TRIO	TWENTY	PTA. PASO
								

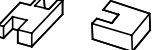
CANTONERAS INFERIORES

FUTURA/ROTARY TEMPLE/BASIC	MOVING	VETRUM	TRIO VITRO	OPEN	GLASS
					

GOMAS

Gomas de cierre burbuja

FUTURA / ROTARY / TEMPLE / BASIC / TRIO

Gomas de iman adhesivas

FUTURA / ROTARY / TEMPLE / BASIC / TRIO

KENNA

Gomas de cierre de imán

FUTURA / ROTARY TEMPLE / BASIC / TWENTY	VETRUM	MOVING	AKTUAL /PRESTIGE TITAN	OPEN / GLASS / GIRO	KENNA

Gomas vierteaguas verticales

FUTURA / ROTARY / TEMPLE BASIC / GLASS / TWENTY	VETRUM	MOVING	AKTUAL/PRESTIGE TITAN	AKORD	KENNA

Gomas de presión

FUTURA / ROTARY TEMPLE / BASIC	VETRUM	MOVING	AKTUAL	SCREEN	OPEN/GLASS	KENNA	TWENTY

Gomas vierteaguas inferiores

FUTURA / ROTARY TEMPLE / BASIC	TRIO	MOVING	AKTUAL	BYPASS	OPEN GLASS	Panel Open	Panel Glass	KENNA

FRENOS DE PUERTA

FUTURA	ROTARY	TEMPLE	MOVING	BASIC	AKTUAL/ PRESTIGE	VITRO	KENNA	TWENTY	PTA. PASO

BISAGRAS

GLASS	GLASS PLEGABLE	SCREEN BISAGRA	SCREEN/OPEN	GIRO 360°	AKORD

REPUESTOS	OPEN	OPEN FROST	OPEN BLACK	GLASS	GLASS PLEGABLE
Cristal Fijo lado de 20					
Cristal Fijo lado de 25					
Cristal Fijo lado de 30					
Cristal Fijo lado de 40					
Cristal Fijo lado de 50					
Cristal Fijo lado de 60					
Puerta de 30					
Puerta de 35					
Puerta de 40					
Puerta de 45					
Puerta de 50					
Puerta de 55					
Puerta de 60					
Puerta de 65					
Puerta de 70					
Puerta de 75					
Puerta de 80					
Puerta de 85					

REPUESTOS TRIO	FJO	INTERM.	PUERTA
Frontal de 90			
Frontal de 95			
Frontal de 100			
Frontal de 105			
Frontal de 110			
Frontal de 115			
Frontal de 120			
Frontal de 125			
Frontal de 130			
Frontal de 135			
Frontal de 140			
Frontal de 145			
Frontal de 150			
Frontal de 155			
Frontal de 160			
Rodamientos trio			

RECAMBIOS GIRO 360°

Puerta Giro 100
Puerta Giro 105
Puerta Giro 110
Toallero 60 cm

RECAMBIOS AKORD

Puerta 70
Puerta 80
Puerta 90
Puerta 100
Goma imán horizontal
Goma imán vertical
Rodamiento

RECAMBIOS BYPASS

Puerta Bypass 120
Puerta Bypass 130
Puerta Bypass 140
Puerta Bypass 150
Puerta Bypass 160

RECAMBIOS CRISTALES FIJO / CORREDERA / LATERAL FIJO

	FUTURA/ROTARY TEMPLE/BASIC/VITRO		VETRUM	MOVING	AKTUAL		PRESTIGE TITAN		KENNA	TWENTY
	TRANSP	F.PLUS	TRANSP	TRANSP	TRANSP	F.PLUS	TRANSP	F.PLUS	TRANSP	TRANSP
Cristal Fijo lado de 70										
Cristal Fijo lado de 75										
Cristal Fijo lado de 80										
Cristal Fijo lado de 90										
Cristal Fijo lado de 100										
Cristal Fijo lado de 110										
Cristal Fijo lado de 120										
Cristal Fijo lado de 130										
Cristal Fijo lado de 140										
Cristal Fijo lado de 150										
Cristal Fijo lado de 160										
Cristal Fijo lado de 170										
Cristal Fijo lado de 180										
Cristal Fijo lado de 190										
Cristal fijo lado de 200										
Corredera lado de 70										
Corredera lado de 75										
Corredera lado de 80										
Corredera lado de 90										
Corredera lado de 100										
Corredera lado de 110										
Corredera lado de 120										
Corredera lado de 130										
Corredera lado de 140										
Corredera lado de 150										
Corredera lado de 160										
Corredera lado de 170										
Corredera lado de 180										
Corredera Lado de 190										
Corredera lado de 200										
Cristal lateral fijo 70										
Cristal lateral fijo 75										
Cristal lateral fijo 80										
Cristal lateral fijo 90										

RECAMBIOS PANELES DE BAÑERA

Bisagra Glass (1 uni)

Brazo soporte
bañera Open

Cristal fijo Open bañera

Puerta Open bañera

Bisagra Open

RECAMBIOS SCREEN

Goma vertical

Goma inferior

Perfil a pared

Perfil corner

Bisagra sup/inf moving

Pinza brazos

BRAZOS SUJECIÓN

Vetrum brazo lateral

Vetrum brazo frontal

Open

Glass

Vitro brazo frontal

Vitro brazo lateral

Vitro brazo vértice

Kenna brazo frontal

Kenna brazo lateral

SERÁ NECESARIO INDICAR MODELO Y REFERENCIA DE LA MAMPARA PARA CURSAR PEDIDO DE CUALQUIER REPUESTO

DESPIECE PUNTOS/REFERENCIA SERIES FUTURA/BASIC/VITRO

	TRANSPARENTE	FROST PLUS
	Ref.	Ref.
Cristales Fijo + Puerta lado de 65-70	5018	6018
Cristales Fijo + Puerta lado de 70-75	5029	6029
Cristales Fijo + Puerta lado de 75-80	5019	6019
Cristales Fijo + Puerta lado de 80-85	5030	6030
Cristales Fijo + Puerta lado de 85-90	5020	6020
Cristales Fijo + Puerta lado de 90-95	5031	6031
Cristales Fijo + Puerta lado de 95-100	5021	6021
Cristales Fijo + Puerta lado de 115-120	5022	6022
Cristales Fijo + Puerta frontal de 95-100	5001	6001
Cristales Fijo + Puerta frontal de 100-105	5002	6002
Cristales Fijo + Puerta frontal de 105-110	5003	6003
Cristales Fijo + Puerta frontal de 110-115	5004	6004
Cristales Fijo + Puerta frontal de 115-120	5005	6005
Cristales Fijo + Puerta frontal de 120-125	5006	6006
Cristales Fijo + Puerta frontal de 125-130	5007	6007
Cristales Fijo + Puerta frontal de 130-135	5008	6008
Cristales Fijo + Puerta frontal de 135-140	5009	6009
Cristales Fijo + Puerta frontal de 140-145	5010	6010
Cristales Fijo + Puerta frontal de 145-150	5011	6011
Cristales Fijo + Puerta frontal de 150-155	5012	6012
Cristales Fijo + Puerta frontal de 155-160	5013	6013
Cristales Fijo + Puerta frontal de 160-165	5014	6014
Cristales Fijo + Puerta frontal de 165-170	5015	6015
Cristales Fijo + Puerta frontal de 170-175	5016	6016
Cristales Fijo + Puerta frontal de 175-180	5017	6017
Cristales Fijo + Puerta frontal de 180-190	5023	6023
Cristales Fijo + Puerta frontal de 190-200	5024	6024
Lateral fijo de 70	5025	6025
Lateral fijo de 75	5057	6057
Lateral fijo de 80	5026	6026
Lateral fijo de 90	5027	6027

PERFILERÍA + ACCESORIOS

	BASIC		VITRO		FUTURA		BASIC TITANIO		BASIC NEGRA	BASIC BL/CR	BASIC BLANCA	
	Ref.	Puntos	Ref.	Puntos	Ref.	Puntos	Ref.	Puntos	Ref.	Ref.	Ref.	Puntos
Kit angular vértice 120x90												
Kit angular vértice 140x100												
Kit frontal hasta 140												
Kit frontal hasta 180												
Kit frontal hasta 200												
Kit spazio hasta 172												
Kit spazio hasta 210												



impresión
digital
a tu gusto

Montaje en fábrica
FRONTALES

impresión
digital
a tu gusto



Montaje en fábrica
ANGULARES

impresión digital sobre vinilo

excepto para Basic, Futura, Rotary y Temple

Personalize su mampara

Hay dos formas de enviarnos la fotografía que quiere que imprimamos :

1. SI ES UNA FOTOGRAFÍA DE CÁMARA DE FOTOS

- Calidad mínima 5 megapíxels
- Enviar en formato JPG

2. SI CREA LA IMAGEN O ES UN ARCHIVO DE IMAGEN

- Imagen de resolución 300 dpi
- Enviar en formato JPG, EPS o PDF
- Color CMYK
- El tamaño debe ser más del 70% del tamaño final de la impresión (1Mpx/m2)
- También valen los archivos vectoriales

NOTA

- Las fotografías muy pesadas se deberán mandar con la aplicación web wetransfer
- Las fotografías de internet no valen, sí se aceptan las de páginas especializadas como www.fotolia.es y comprar la foto, dando la opción de que el cliente nos envíe la referencia y nosotros la compramos. En este caso se le facturará al cliente el coste de la fotografía
- Montaje solo en fábrica
- Plazo de entrega 20 días
- GME no iniciará la producción del vinilo si la fotografía recibida no reúne las características necesarias para su correcta impresión, comunicando al cliente la imposibilidad de realizarla con la mayor brevedad posible

Gracias a las posibilidades que ofrecen las modernas técnicas de impresión digital, ahora podemos dar personalidad a nuestras mamparas.

Con este tipo de impresión, se puede dar al cristal una imagen única, gracias a la incorporación de fotografías, dibujos, logos, letras, símbolos y mucho más.

Nuestro sistema de impresión digital incorpora una lámina para la protección y conservación de la imagen del vinilo.

9 modelos de vinilos poliméricos

TRAZOS



FROST PLUS



FROST



SKY LINE



GOTAS



BAMBÚ



ANGLES



DESERT



METEOR



Plantilla cristales decorados vinilos

- | | | | |
|--------------|--------------------------|----------|--------------------------|
| A trazos | <input type="checkbox"/> | E gotas | <input type="checkbox"/> |
| B frost plus | <input type="checkbox"/> | F bambú | <input type="checkbox"/> |
| C frost | <input type="checkbox"/> | G angles | <input type="checkbox"/> |
| D sky line | <input type="checkbox"/> | H desert | <input type="checkbox"/> |
| I meteor | <input type="checkbox"/> | | |

Cliente
Modelo mampara
Descripción
Referencia

Formato

F: FIJO

P: PUERTA

FRONTAL

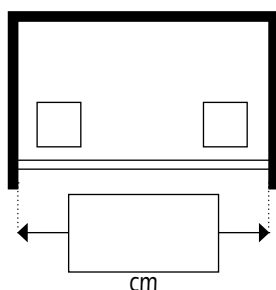

APERTURA VERTICE IZO

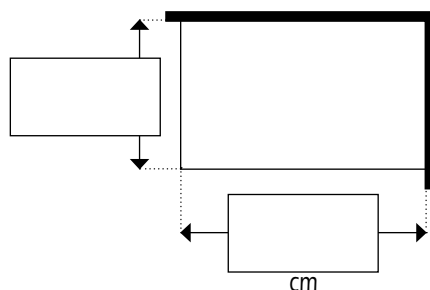

APERTURA VERTICE DER

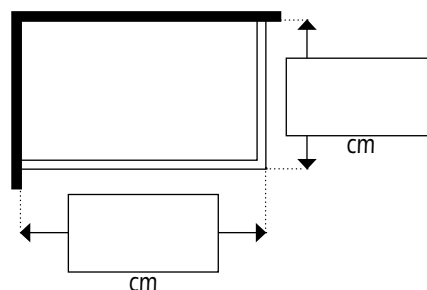

FRONTAL con LATERAL FIJO

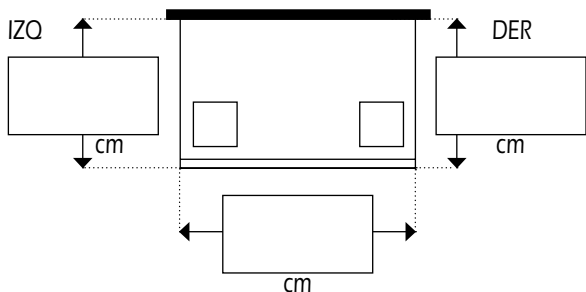

SEMICIRCULAR

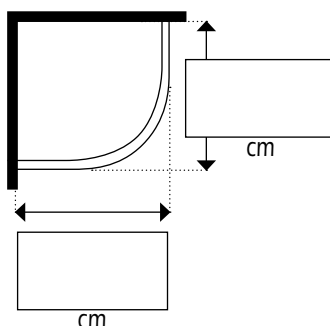

EJEMPLO FRONTAL

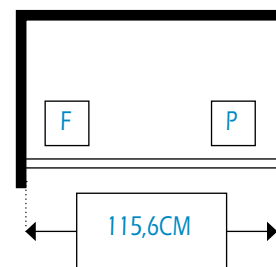

Altura decorado (max. 118cm)

		ref.
MONTAJE EN GME FROST / FROST PLUS ÁCIDO	FRONTALES	OFROST1
	ANGULARES	OFROST2
MONTAJE EN GME RESTO VINILOS	FRONTALES	0021
	ANGULARES	0020
MONTAJE EN GME IMPRESIÓN DIGITAL VINILOS	FRONTALES	0019
	ANGULARES	0018
SOLO VINILO, MONTAJE A CARGO DEL CLIENTE	FRONTALES	0023
	ANGULARES	0022

plazo de entrega
1 semana

EXPOSITORES MAMPARAS

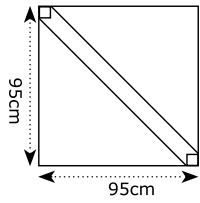

ref. GME01
2 Mamparas de **90x90**

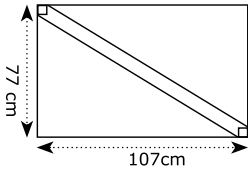

ref. GME02
2 Mamparas de **100x70**

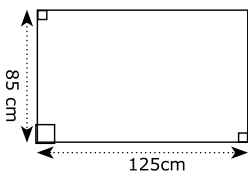

ref. GME04
3 Mamparas
mampara **120x80**
open/akord **70**
frontal **110**

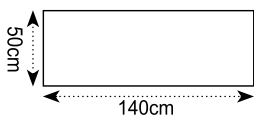

ref. GME07
3 Mamparas
frontal **140**



ref. GME11
Exposición con mástiles de 2 m en
aluminio lacado blanco

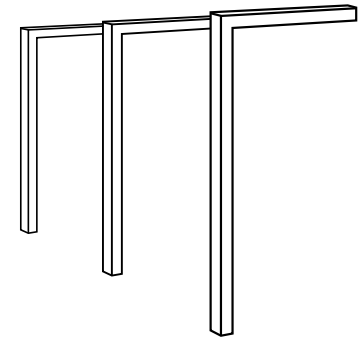

EXPOSITOR PLATOS



ref. GME06
2 platos 120x70
120x80

EXPOSITOR LAVABOS



ref. GME05
8 lavabos cerámicos

EXPOSITORES GRIFERÍA IO



ref. GME03
4 columnas ó duchas vistas

ref. GME09
4 conjuntos grifería
2 duchas vistas/1 ducha+empotrable



ref. GME10
6 grifos IO
1 ducha vista



ref. GME13
Medida 80x40 cm
9 grifos IO



ref. GME14
Medida 120x61 cm
14 grifos IO



ref. GME08
3 grifos IO



ref. GME12
2 grifos IO

QME

GME

DIVISION BAÑOS



GME DIVISI3N BAÑOS S.L.

Polígono Ciudad de Mudeco
C/ Pinadeta 16 - 46930
Quart de Poblet - Valencia - España

ATENCI3N AL CLIENTE

Telf. +34 96 252 18 55
Fax +34 96 252 18 56
info@gmelorente.com
www.gmelorente.com

☎ 672 639 362

PEDIDOS

pedidos@gmelorente.com

